

Metal Affinities Price list

Furniture: Cabinets & Sideboard, Bookcases, Console, Tables, Seatings, Coffee tables, Dividers, Lightings, Mirrors, Frames, Pots, Landscape. Surfaces: Tiles, Mosaics, Decorative.

April 2024

Public price VAT Excluded
Prezzi al pubblico IVA esclusa

04/2024

Product index

FURNITURE / ARREDO

Cabinets & Sideboards	10	Canneto Barista	38	Marea Chest of drawers
Madie & Credenze	12	Canneto Cabinet	42	Marea Dresser
	14	Canneto Floor console	44	Marea Sideboard NEW
	16	Canneto Wall mounted console	48	Mida
	18	Celato Bedside table	50	Pandora
	20	Celato Chest of drawers	54	Polifemo
	24	Celato Floor console	56	Ripple
	26	Celato Wall mounted console	58	Sculpt NEW
	28	Elizabeth Console	62	Tako Floor console
	30	Elizabeth Sideboard NEW	64	Tako Wall mounted console
	32	Graffio	66	Xilo Console NEW
	34	Longing Cabinet	70	Yoroi
	36	Marea Cabinet		

Bookcases	74	Airframe	90	Nami
Librerie	76	Babele	92	Nippon
	82	Existence round	94	Talea
	86	Existence wall		

Consoles	104	Convivium Console	108	Folio Console NEW
Consolle	106	Existence Console	110	Sinestesia Console

Tables	114	Baia	124	Folio Table round NEW
Tavoli	116	Burraco Table & Pouf	126	Plateaux of Mirror
	118	Convivium Table	128	Roma
	120	Coste Table	130	Vela
	122	Folio Table		

Seatings	134	Caravan Armchair	144	Efesto
Sedute	136	Caravan Sofa	146	Pensando ad Acapulco
	138	Loom Sofa	148	Via Veneto
	140	Loom Pouf	150	Wave
	142	Ori		

Coffee Tables	154	Alchemy	174	Parsec
Tavolini	158	Alpha	178	Placas
	160	Band	180	Scribble
	162	Between Nature	184	Sunrise & Sunset
	164	Botero NEW	186	Syro
	166	Drops	188	Syro XL
	170	Flocks NEW	190	Xilo Coffee tables
	172	Nicola		

Dividers	194	Monolite		
Divisori	196	Painting		

Lightings	200	Aare Ceiling NEW	208	Luce Solida
Luci	202	Aare Wall NEW	210	Ribot
	204	Foliage NEW	212	Twist Ceiling
	206	Light&Shade NEW	214	Twist Table

Mirrors	218	Brame	222	Riflesso
Specchi	220	Frame	224	Syro Mirror

Frame	228	Arazzi Re	230	Solar
Quadri	228	Arazzi Regina	231	Wild Geometries
	229	Erosion	231	Yoko 01
	229	Hexagon	232	Yoko 02
	230	Poyagi	232	Your signature

Pots	236	A-Modulo	260	Narnya
Vasi	240	Cohiba large	264	Phil
	242	Cohiba slim	266	Riviera Pots
	244	Conique	270	Rocco
	246	Cube	272	Lolita
	248	Dafne & Demetra	274	Screen-Pot
	252	Delta	276	Shimla & Jaipur
	256	Omega	278	Tristan & Isotte

Landscape	284	Cottage N.1	288	Nest House N.1
	286	Dog House N.1		

SURFACES / SUPERFICI

Tiles	292	Cipher	296	Forma
Piastrelle	294	DeErosion	304	Yoko

Mosaics	310	Copycat NEW	320	Square 30
Mosaici	314	Diamond 30	322	Square 50
	316	Losanga		

Decorative	326	3D Wall	334	DecoDe
Decorativi	330	Circle Wall	338	Vertical Green

6 Key / Legenda





7 Types of packaging / Tipologie di imballo

344 Materioteca

348 Sales conditions / Termini e condizioni di vendita





Key Legenda

FURNITURE KEY

IN	Product suitable for indoor use
OUT	Product suitable for outdoor use
	Net weight
	Gross weight
	Packaging dimensions
	Packaging volume
	Number of packagings













ENKADRAIN Drainage and filter mat comprising two thermobonded polyester spunbond non-woven fabric filters either side of a drainage structure made of polyamide monofilaments. Resistant to high and low temperatures.

LEGENDA PER ARREDO













IN	Prodotto indicato per uso interno
OUT	Prodotto indicato per uso esterno
	Peso netto
	Peso lordo
	Dimensioni imballo
	Volume imballo
	Numero colli

ENKADRAIN Materassino drenante e filtrante costituito da 2 filtri in tessuto non tessuto termosaldato a filo continuo in poliestere con interposta una struttura drenante realizzata in monofilamenti in poliammide. Resistente alle basse e alte temperature

SURFACES KEY

	(or " IN ") Product suitable for indoor use
	(or " OUT ") product suitable for outdoor use
	Wall
	Floor
	Net weight
	Net weight per square meter
	Gross weight
	Packaging dimensions
	Packaging volume
	Dimension as per project
	Thickness
	Modules or tiles per square meter

LEGENDA PER SUPERFICI

	(o " IN ") Prodotto indicato per uso interno
	(o " OUT ") Prodotto indicato per uso esterno
	Parete
	Pavimento
	Peso netto
	Peso netto per metro quadro
	Peso lordo
	Dimensioni imballo
	Volume imballo
	Dimensioni come da progetto
	Spessore
	Moduli o piastrelle per metro quadro

UNIT OF MEASUREMENT / UNITÀ DI MISURA: CM

Types of packaging

Tipologie di imballo

TYPE A / TIPO A

WOODEN CRATE
CASSE IN LEGNO

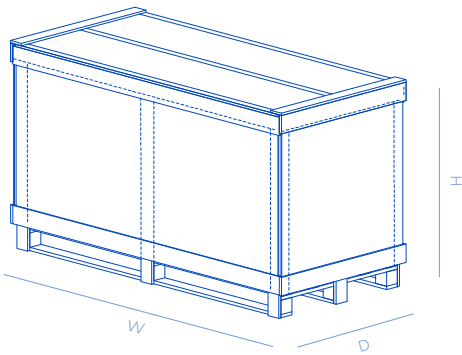

TYPE B / TIPO B

WOODEN CRATE
CASSE IN LEGNO

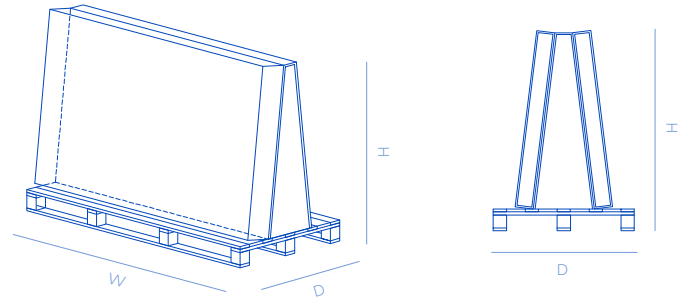

TYPE C / TIPO C

GABBIA IN LEGNO
WOODEN CAGE

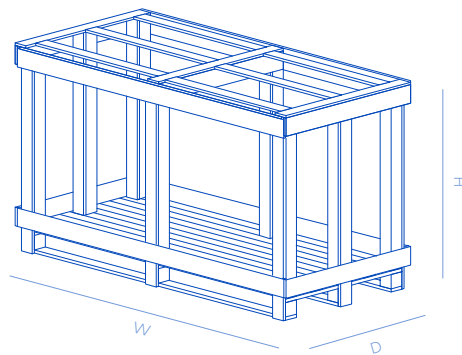

TYPE D / TIPO D

WOODEN CRATE
CASSE IN LEGNO

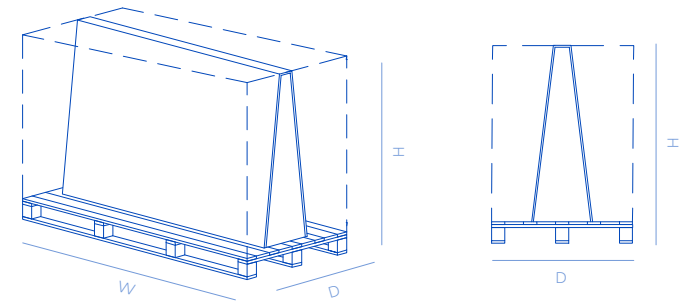

TYPE E / TIPO E

CARTON BOX
SCATOLA IN CARTONE

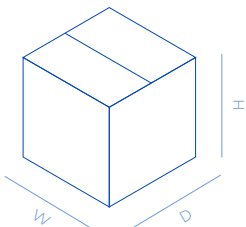

Cabinets & Sideboards
Madie & Credenze

Canneto Barista

DESIGN BY ADRIANO DESIGN

Bar cabinet with wooden structure clad with metal tubes of different diameters. Book opening through hidden wheels at the bottom. Equipped inside with glass shelves and polished stainless steel covering.

Mobile bar con struttura il legno rivestito in tubolari in metallo di diverso diametro. Apertura a libro mediante rotelle nascoste alla base. Ripiani in vetro e rivestimento interno in acciaio inox lucido.

Canneto Barista
DC668

Open / Aperto

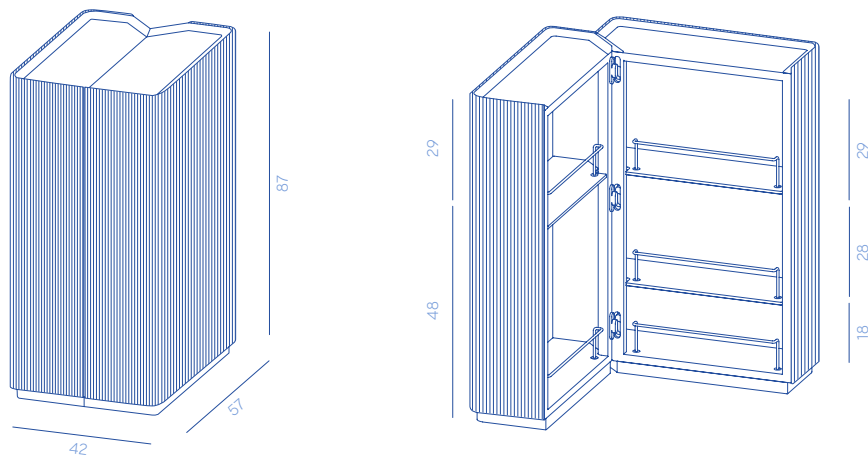

METAL FINISHES



M11

M9

M10

PRODUCT SPECIFICATION

Structure	Canaletto walnut wood 
Assembly	Shelves shipped disassembled
Packaging	Wooden crate included TYPE A
Details	<ul style="list-style-type: none"> - Clad in metal on all sides - Internally clad in polished stainless steel - Book opening with hidden wheels at the bottom - Two glass shelves on the left side and three on the right side included

SPECIFICHE PRODOTTO

Struttura	Legno noce canaletto 
Assemblaggio	Mensole spedite smontate
Imballo	Imballo in cassa inclusa TIPO A
Dettagli	<ul style="list-style-type: none"> - Rivestito in metallo su tutti i lati - Rivestito internamente in acciaio inox lucido - Apertura a libro con ruote nascoste nella parte inferiore - Due ripiani in vetro sul lato sinistro e tre sul lato destro inclusi

ON REQUEST

Finishes	The product is available only in the finishes listed
Dimensions	The product is available only in the dimensions listed

SU RICHIESTA

Finiture	Il prodotto è disponibile nelle sole finiture previste
Dimensioni	Il prodotto è disponibile solo nelle dimensioni previste

CANNETO BARISTA

W. 57 D. 42 H. 87 cm

CODE / CODICE	IN	OUT	METAL FINISHES			EURO
DC668-M11	•		Stainless steel Acciaio inox	Brushed Spazzolato	M11	15.000,00
DC668-M9	•		Brass Ottone	Brushed Spazzolato	M9	17.800,00
DC668-M10	•		Copper Rame	Brushed Spazzolato	M10	19.600,00

 78 kg

 108 kg

 W. 75 D. 60 H. 117 cm

 0,53 m³

 1

Excluding VAT
IVA esclusa

Canneto Cabinet

DESIGN BY ADRIANO DESIGN

Cabinet with wooden structure clad with metal tubes of different diameters. 2 "L" doors with 90° opening, internally equipped with shelves and dividers. The metal top is in a slightly lowered position if compared to doors and perimeter.

Cabinet con struttura il legno rivestito in tubolari in metallo di diverso diametro. 2 ante ad "L" con apertura a 90°, internamente attrezzato con ripiani e divisori. Il top in metallo è in posizione leggermente ribassata rispetto alle ante e al perimetro.

Canneto Cabinet
DC674

Open / Aperto

Internal measurements / Misure interne

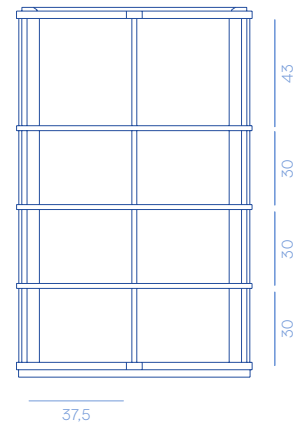
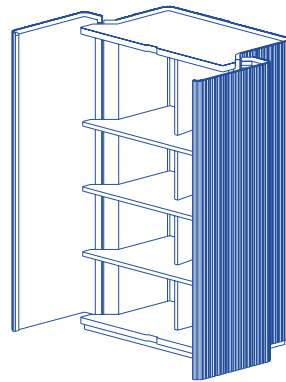
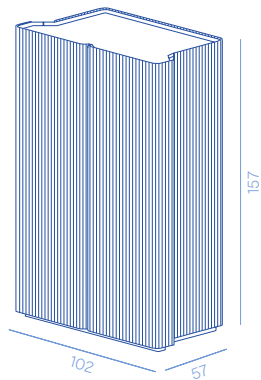

METAL FINISHES



M11



M9

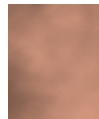

M10

PRODUCT SPECIFICATION

Structure	Canaletto walnut wood 
Assembly	Shipped assembled
Packaging	Wooden crate included TYPE A
Details	<ul style="list-style-type: none"> - Clad in metal on all sides - Two "L" doors with 90° opening - Fixed inner shelves and divider as per drawings

SPECIFICHE PRODOTTO

Struttura	Legno noce canaletto 
Assemblaggio	Spedito montato
Imballo	Imballo in cassa incluso TIPO A
Dettagli	<ul style="list-style-type: none"> - Rivestito in metallo su tutti i lati - Due ante a "L" con apertura a 90° - Ripiani interni fissi e divisorio come da disegno

ON REQUEST

Finishes	The product is available only in the finishes listed
Dimensions	The product is available only in the dimensions listed

SU RICHIESTA

Finiture	Il prodotto è disponibile nelle sole finiture previste
Dimensioni	Il prodotto è disponibile solo nelle dimensioni previste

CANNETO CABINET

W. 102 D. 57 H. 157 cm

CODE / CODICE	IN	OUT	METAL FINISHES			EURO
DC674-M11	•		Stainless steel Acciaio inox	Brushed Spazzolato	M11	32.900,00
DC674-M9	•		Brass Ottone	Brushed Spazzolato	M9	36.200,00
DC674-M10	•		Copper Rame	Brushed Spazzolato	M10	37.800,00

 205 kg

 240 kg

 W. 120 D. 74 H. 182 cm

 1,62 m³

 1

Excluding VAT
IVA esclusa

Canneto floor Console

DESIGN BY ADRIANO DESIGN

Free-standing console with wooden structure clad with metal tubes of different diameters with 2 drawers and 2 side doors. The central drawers are equipped with an inner drawer each.

Mobile consolle free-standing con struttura il legno rivestito in tubolari in metallo di diverso diametro a 2 cassetti e 2 ante laterali. I cassetti centrali prevedono ciascuno un cassetto interno.

Canneto floor Console 118
DC688T

Closed / Chiuso

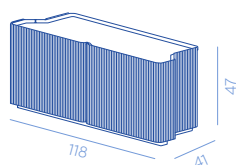

Internal measurements / Misure interne

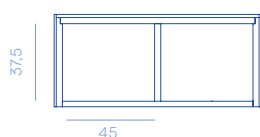

Canneto floor Console 234
DC673T

Open / Aperto

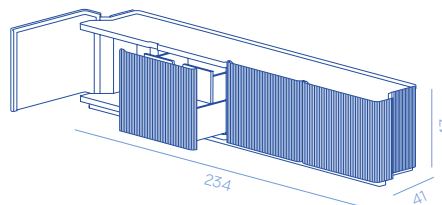

Internal measurements / Misure interne

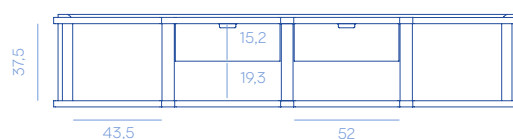

METAL FINISHES



M11

M9

M10

PRODUCT SPECIFICATION

Structure	Canaletto walnut wood 
Assembly	Shipped assembled
Packaging	Wooden crate included TYPE A
Details DC688T DC673T	<ul style="list-style-type: none"> - Clad in metal on all sides - Two side doors opening - Two side doors opening and two central drawers with a inner drawer each - Pull opening with full-extension Blumotion Movento slides by Blum drawers

SPECIFICHE PRODOTTO

Struttura	Legno noce canaletto 
Assemblaggio	Spedito montato
Imballo	Imballo in cassa incluso TIPO A
Dettagli DC688T DC673T	<ul style="list-style-type: none"> - Rivestito in metallo su tutti i lati - Apertura a due ante laterali - Due ante laterali apribili e due cassetti centrali con un cassetto interno ciascuno - Apertura a tirare con guide Blumotion Movento di Blum ad estrazione totale

ON REQUEST

Finishes	The product is available only in the finishes listed
Dimensions	The product is available only in the dimensions listed

SU RICHIESTA

Finiture	Il prodotto è disponibile nelle sole finiture previste
Dimensioni	Il prodotto è disponibile solo nelle dimensioni previste

CANNETO 118 FLOOR CONSOLE

W. 118 D. 41 H. 47 cm

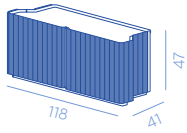

CODE / CODICE	IN	OUT	METAL FINISHES			EURO
DC688T-M11	•		Stainless steel Acciaio inox	Brushed Spazzolato	M11	20.000,00
DC688T-M9	•		Brass Ottone	Brushed Spazzolato	M9	22.000,00
DC688T-M10	•		Copper Rame	Brushed Spazzolato	M10	23.500,00

kg 65 kg
kg 115 kg
cm W. 134 D. 57 H. 72 cm
m³ 0,55 m³
N° 1
Excluding VAT
IVA esclusa

CANNETO 234 FLOOR CONSOLE

W. 234 D. 41 H. 47 cm

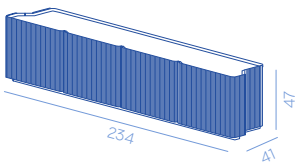

CODE / CODICE	IN	OUT	METAL FINISHES			EURO
DC673T-M11	•		Stainless steel Acciaio inox	Brushed Spazzolato	M11	30.300,00
DC673T-M9	•		Brass Ottone	Brushed Spazzolato	M9	32.000,00
DC673T-M10	•		Copper Rame	Brushed Spazzolato	M10	34.000,00

kg 130 kg
kg 165 kg
cm W. 253 D. 60 H. 80 cm
m³ 1,21 m³
N° 1
Excluding VAT
IVA esclusa

Canneto wall-mounted Console

DESIGN BY ADRIANO DESIGN

Wall-mounted console with wooden structure clad with metal tubes of different diameters with 2 drawers and 2 side doors. The central drawers are equipped with an inner drawer each.

Mobile consolle sospesa a parete con struttura il legno rivestito in tubolari in metallo di diverso diametro a 2 cassetti e 2 ante laterali. I cassetti centrali prevedono ciascuno un cassetto interno.

Canneto wall mounted Console 118
DC688

Closed / Chiuso

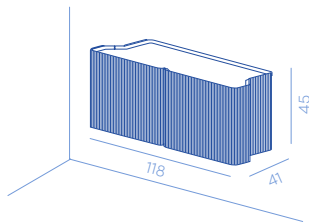

Internal measurements / Misure interne

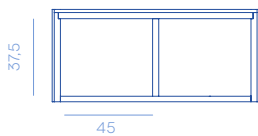

Canneto wall mounted Console 234
DC673

Open / Aperto

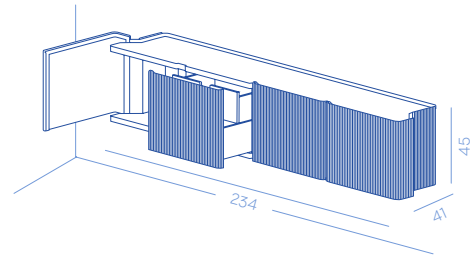

Internal measurements / Misure interne

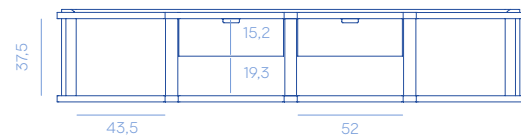

METAL FINISHES

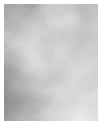

M11

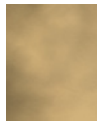

M9

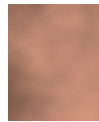

M10

PRODUCT SPECIFICATION

Structure	Canaletto walnut wood 
Assembly	Shipped assembled
Packaging	Wooden crate included TYPE A
Details	<ul style="list-style-type: none"> - Clad in metal on all sides, back excluded - Load-bearing wall or reinforced plasterboard is required - Wall fixing system included, fixing screws excluded - Two doors opening - Two side doors opening and two central drawers with a inner drawer each - Pull opening with full-extension Blumotion Movento slides by Blum
DC688 DC673	

ON REQUEST

Finishes	The product is available only in the finishes listed
Dimensions	The product is available only in the dimensions listed

SPECIFICHE PRODOTTO

Struttura	Legno noce canaletto 
Assemblaggio	Spedito montato
Imballo	Imballo in cassa incluso TIPO A
Details	<ul style="list-style-type: none"> - Rivestito in metallo su tutti i lati, schienale escluso - È necessaria una parete portante o un cartongesso rinforzato - Sistema di fissaggio a parete incluso, viti di fissaggio escluse - Apertura a due ante - Due ante laterali apribili e due cassetti centrali con un cassetto interno ciascuno - Apertura a tirare con guide Blumotion Movento di Blum ad estrazione totale
DC688 DC673	

SU RICHIESTA

Finiture	Il prodotto è disponibile nelle sole finiture previste
Dimensioni	Il prodotto è disponibile solo nelle dimensioni previste

CANNETO 118 WALL-MOUNTED CONSOLE

W. 118 D. 41 H. 45 cm

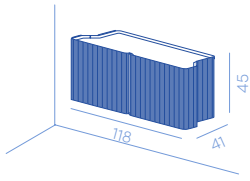

CODE / CODICE	IN	OUT	METAL FINISHES			EURO
DC688-M11	•		Stainless steel Acciaio inox	Brushed Spazzolato	M11	19.500,00
DC688-M9	•		Brass Ottone	Brushed Spazzolato	M9	21.500,00
DC688-M10	•		Copper Rame	Brushed Spazzolato	M10	23.000,00

kg 65 kg

kg 115 kg

cm W. 134 D. 57 H. 72 cm

m³ 0,55 m³

N° 1

Excluding VAT
IVA esclusa

CANNETO 234 WALL-MOUNTED CONSOLE

W. 234 D. 41 H. 45 cm

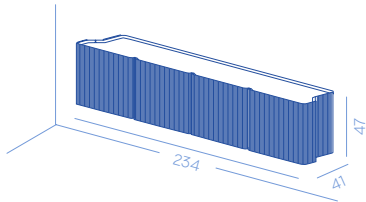

CODE / CODICE	IN	OUT	METAL FINISHES			EURO
DC673-M11	•		Stainless steel Acciaio inox	Brushed Spazzolato	M11	28.300,00
DC673-M9	•		Brass Ottone	Brushed Spazzolato	M9	30.000,00
DC673-M10	•		Copper Rame	Brushed Spazzolato	M10	31.200,00

kg 130 kg

kg 165 kg

cm W. 253 D. 60 H. 80 cm

m³ 1,21 m³

N° 1

Excluding VAT
IVA esclusa

Celato Bedside table

DESIGN BY R&D DE CASTELLI

Bedside table clad in metal on all sides with invisible drawers with push-pull opening.

Comodino rivestito in metallo su tutti i lati con cassetti invisibili con apertura push-pull.

Celato 45
DC347

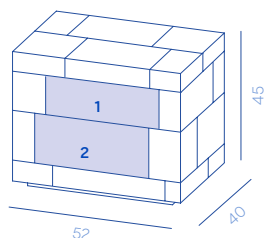

Internal drawers measures
Misure interne cassetti

DRAWER CASSETTO	DIMENSIONS DIMENSIONI
1	W. 32,5 D. 31 H. 8,5 cm
2	W. 32,5 D. 31 H. 12,5 cm

METAL FINISHES

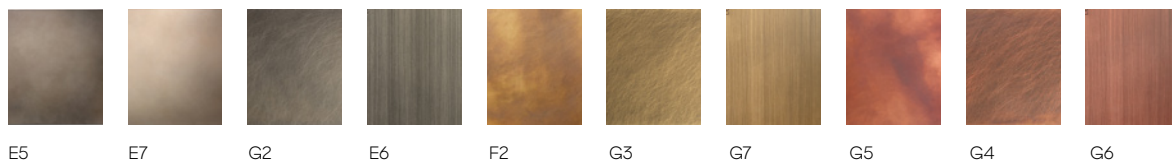

PRODUCT SPECIFICATION

Structure	Natural birch wood 
Assembly	Shipped assembled
Packaging	Wooden crate included TYPE A
Details	<ul style="list-style-type: none"> - Clad in metal on all sides - Hidden drawers as per drawings - Push and pull opening with full-extension Movento slides by Blum

SPECIFICHE PRODOTTO

Struttura	Legno di betulla naturale 
Assemblaggio	Spedito montato
Imballo	Imballo in cassa incluso TIPO A
Dettagli	<ul style="list-style-type: none"> - Rivestito in metallo su tutti i lati - Cassetti nascosti come da disegno - Apertura push and pull con guide Movento di Blum ad estrazione totale

ON REQUEST

Finishes	<ul style="list-style-type: none"> - The product can also be made upon request, subject to confirmation of feasibility by De Castelli - Price is on request
Dimensions	<ul style="list-style-type: none"> - The product can also be made in dimensions on request, subject to confirmation of feasibility by De Castelli - For custom made products please specify the number of drawers as well as the dimensions, material and finishing - Price is on request

SU RICHIESTA

Finiture	<ul style="list-style-type: none"> - Il prodotto può essere realizzato anche in finiture su richiesta, previa conferma fattibilità da parte di De Castelli - Il prezzo è su richiesta
Dimensioni	<ul style="list-style-type: none"> - Il prodotto può essere realizzato anche in dimensioni su richiesta, previa conferma fattibilità da parte di De Castelli - In fase di richiesta specificare oltre al numero di cassetti, le dimensioni, il materiale e la finitura - Il prezzo è su richiesta

CELATO 45 BEDSIDE TABLE

W. 52 D. 40 H. 45 cm

CODE / CODICE	IN	OUT	METAL FINISHES			EURO
DC347-E5	•		Stainless steel Acciaio inox	DeLabré B DeLabré B	E5	5.110,00
DC347-E7	•		Stainless steel Acciaio inox	DeDarié DeDarié	E7	5.150,00
DC347-G2	•		Stainless steel Acciaio inox	Orbitale DeLabré DeLabré orbitale	G2	5.250,00
DC347-E6	•		Stainless steel Acciaio inox	Striped DeLabré DeLabré striato	E6	5.350,00
DC347-F2	•		Brass Ottone	DeLabré DeLabré	F2	5.380,00
DC347-G3	•		Brass Ottone	Orbitale DeLabré DeLabré orbitale	G3	5.700,00
DC347-G7	•		Brass Ottone	Striped DeLabré DeLabré striato	G7	6.150,00
DC347-G5	•		Copper Rame	DeLabré DeLabré	G5	5.950,00
DC347-G4	•		Copper Rame	Orbitale DeLabré DeLabré orbitale	G4	6.050,00
DC347-G6	•		Copper Rame	Striped DeLabré DeLabré striato	G6	6.500,00

 37 kg

 52 kg

 W. 62 D. 82 H. 72 cm

 0,37 m³

 1

Excluding VAT
IVA esclusa

Celato Chest of drawers

DESIGN BY R&D DE CASTELLI

Low chest of drawers clad in metal on all sides with invisible drawers with push-pull opening.
Cassettiera bassa rivestita in metallo su tutti i lati con cassetti invisibili con apertura push-pull.

Celato 80
DC345

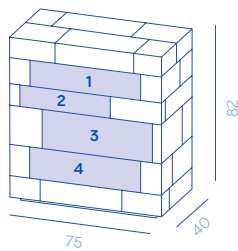

DRAWER CASSETTO	DIMENSIONS DIMENSIONI
1	W.51 D.31 H.11 cm
2	W.41 D.31 H.6 cm
3	W.52 D.31 H.16 cm
4	W.51 D.31 H.11 cm

Celato 130
DC346

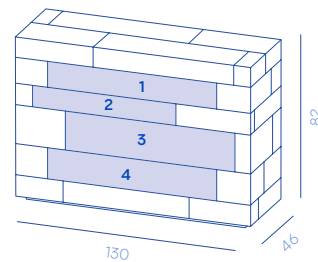

DRAWER CASSETTO	DIMENSIONS DIMENSIONI
1	W.91 D.36 H.10,5 cm
2	W.76 D.36 H.6 cm
3	W.91 D.36 H.16 cm
4	W.91 D.36 H.11 cm

METAL FINISHES

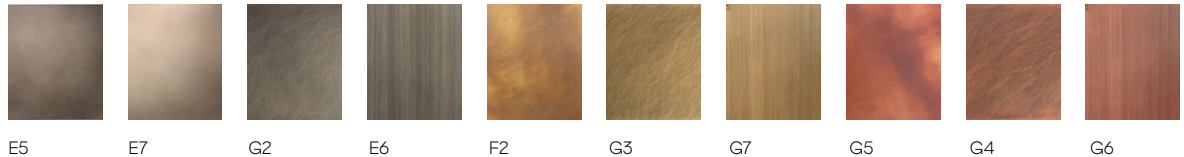

PRODUCT SPECIFICATION

Structure	Natural birch wood 
Assembly	Shipped assembled
Packaging	Wooden crate included TYPE A
Details	<ul style="list-style-type: none"> – Clad in metal on all sides – Hidden drawers as per drawings – Push and pull opening with full-extended Movento slides by Blum

SPECIFICHE PRODOTTO

Struttura	Legno di betulla naturale 
Assemblaggio	Spedito montato
Imballo	Imballo in cassa incluso TIPO A
Dettagli	<ul style="list-style-type: none"> – Rivestito in metallo su tutti i lati – Cassetti nascosti come da disegno – Apertura push and pull con guide Movento di Blum ad estrazione totale

ON REQUEST

Finishes	<ul style="list-style-type: none"> – The product can also be made upon request, subject to confirmation of feasibility by De Castelli – Price is on request
Dimensions	<ul style="list-style-type: none"> – The product can also be made in dimensions on request, subject to confirmation of feasibility by De Castelli – For custom made products please specify the number of drawers as well as the dimensions, material and finishing – Price is on request

SU RICHIESTA

Finiture	<ul style="list-style-type: none"> – Il prodotto può essere realizzato anche in finiture su richiesta, previa conferma fattibilità da parte di De Castelli – Il prezzo è su richiesta
Dimensioni	<ul style="list-style-type: none"> – Il prodotto può essere realizzato anche in dimensioni su richiesta, previa conferma fattibilità da parte di De Castelli – In fase di richiesta specificare oltre al numero di cassetti, le dimensioni, il materiale e la finitura – Il prezzo è su richiesta

CELATO 80 CHEST OF DRAWERS

W. 75 D. 40 H. 82 cm

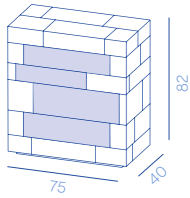

CODE / CODICE	IN	OUT	METAL FINISHES			EURO
DC345-E5	•		Stainless steel Acciaio inox	DeLabré B DeLabré B	E5	6.050,00
DC345-E7	•		Stainless steel Acciaio inox	DeDarié DeDarié	E7	6.100,00
DC345-G2	•		Stainless steel Acciaio inox	Orbitale DeLabré DeLabré orbitale	G2	6.250,00
DC345-E6	•		Stainless steel Acciaio inox	Striped DeLabré DeLabré striato	E6	6.600,00
DC345-F2	•		Brass Ottone	DeLabré DeLabré	F2	7.000,00
DC345-G3	•		Brass Ottone	Orbitale DeLabré DeLabré orbitale	G3	7.120,00
DC345-G7	•		Brass Ottone	Striped DeLabré DeLabré striato	G7	7.840,00
DC345-G5	•		Copper Rame	DeLabré DeLabré	G5	6.870,00
DC345-G4	•		Copper Rame	Orbitale DeLabré DeLabré orbitale	G4	7.750,00
DC345-G6	•		Copper Rame	Striped DeLabré DeLabré striato	G6	8.070,00

kg 54 kg

kg 70 kg

cm W. 93 D. 58 H. 112 cm

m³ 0,6m³

N° 1

Excluding VAT
IVA esclusa

CELATO 130 CHEST OF DRAWERS

W. 130 D. 46 H. 82 cm

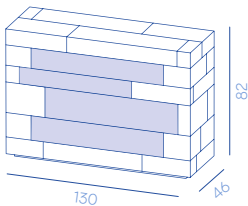

CODE / CODICE	IN	OUT	METAL FINISHES / MATERIALI E FINITURE			EURO
DC346-E5	•		Stainless steel Acciaio inox	DeLabré B DeLabré B	E5	7.850,00
DC346-E7	•		Stainless steel Acciaio inox	DeDarié DeDarié	E7	7.950,00
DC346-G2	•		Stainless steel Acciaio inox	Orbitale DeLabré DeLabré orbitale	G2	8.500,00
DC346-E6	•		Stainless steel Acciaio inox	Striped DeLabré DeLabré striato	E6	8.600,00
DC346-F2	•		Brass Ottone	DeLabré DeLabré	F2	8.740,00
DC346-G3	•		Brass Ottone	Orbitale DeLabré DeLabré orbitale	G3	8.850,00
DC346-G7	•		Brass Ottone	Striped DeLabré DeLabré striato	G7	10.080,00
DC346-G5	•		Copper Rame	DeLabré DeLabré	G5	9.850,00
DC346-G4	•		Copper Rame	Orbitale DeLabré DeLabré orbitale	G4	9.980,00
DC346-G6	•		Copper Rame	Striped DeLabré DeLabré striato	G6	10.300,00

kg 100 kg

kg 120 kg

cm W. 147 D. 63 H. 112 cm

m³ 1,04 m³

N° 1

Excluding VAT
IVA esclusa

Celato Chest of drawers

DESIGN BY R&D DE CASTELLI

High chest of drawers clad in metal on all sides with invisible drawers with push-pull opening.

Cassettiera settimanale rivestita in metallo su tutti i lati con cassetti invisibili con apertura push-pull.

Celato 160
DC343

Internal drawers measures
Misure interne cassetti

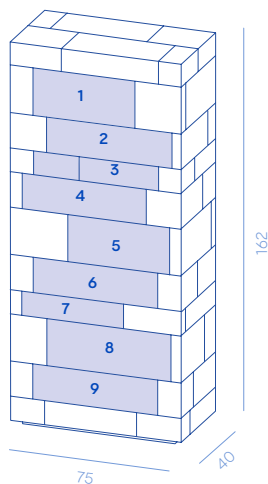

DRAWER CASSETTO	DIMENSIONS DIMENSIONI
1	W.41 D.31 H.15,5 cm
2	W.51 D.31 H.10,5 cm
3*	W.51 D.31 H.5,5 cm
4	W.51 D.31 H.10,5 cm
5	W.41 D.31 H.13,5cm
6	W.51 D.31 H.10,5 cm
7	W.41 D.31 H.5,5 cm
8	W.51 D.31 H.15,5 cm
9	W.51 D.31 H.10,5 cm

*Two covering elements identify a single drawer (3).

*Due elementi di rivestimenti individuano un cassetto unico (3).

METAL FINISHES

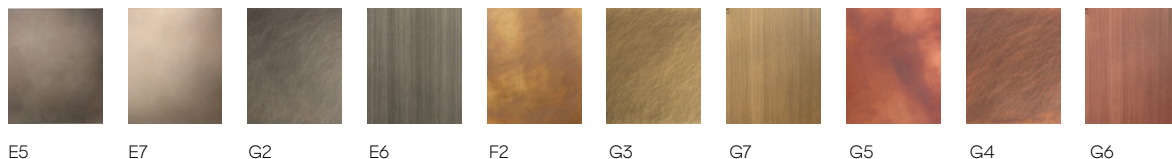

PRODUCT SPECIFICATION

Structure	Natural birch wood 
Assembly	Shipped assembled
Packaging	Wooden crate included TYPE A
Details	<ul style="list-style-type: none"> - Clad in metal on all sides - Hidden drawers as per drawings - Push and pull opening with full-extension Movento slides by Blum - Equipped with hidden secretaire by removing the drawer at the bottom

SPECIFICHE PRODOTTO

Struttura	Legno di betulla naturale 
Assemblaggio	Spedito montato
Imballo	Imballo in cassa incluso TIPO A
Dettagli	<ul style="list-style-type: none"> - Rivestito in metallo su tutti i lati - Cassetti nascosti come da disegno - Apertura push and pull con guide Movento di Blum ad estrazione totale - Dotato di secretaire nascosta accessibile rimuovendo l'ultimo cassetto in basso

ON REQUEST

Finishes	<ul style="list-style-type: none"> - The product can also be made upon request, subject to confirmation of feasibility by De Castelli - TPrice is on request
Dimensions	<ul style="list-style-type: none"> - The product can also be made in dimensions on request, subject to confirmation of feasibility by De Castelli - For custom made products please specify the number of drawers as well as the dimensions, material and finishing - Price is on request

SU RICHIESTA

Finiture	<ul style="list-style-type: none"> - Il prodotto può essere realizzato anche in finiture su richiesta, previa conferma fattibilità da parte di De Castelli - Il prezzo è su richiesta
Dimensioni	<ul style="list-style-type: none"> - Il prodotto può essere realizzato anche in dimensioni su richiesta, previa conferma fattibilità da parte di De Castelli - In fase di richiesta specificare oltre al numero di cassetti, le dimensioni, il materiale e la finitura - Il prezzo è su richiesta

CELATO 160 CHEST OF DRAWERS

W. 160 D. 40 H. 162 cm

CODE / CODICE	IN	OUT	METAL FINISHES			EURO
DC343-E5	•		Stainless steel Acciaio inox	DeLabré B DeLabré B	E5	11.200,00
DC343-E7	•		Stainless steel Acciaio inox	DeDarié DeDarié	E7	11.400,00
DC343-G2	•		Stainless steel Acciaio inox	Orbitale DeLabré DeLabré orbitale	G2	11.980,00
DC343-E6	•		Stainless steel Acciaio inox	Striped DeLabré DeLabré striato	E6	12.550,00
DC343-F2	•		Brass Ottone	DeLabré DeLabré	F2	13.440,00
DC343-G3	•		Brass Ottone	Orbitale DeLabré DeLabré orbitale	G3	13.780,00
DC343-G7	•		Brass Ottone	Striped DeLabré DeLabré striato	G7	14.450,00
DC343-G5	•		Copper Rame	DeLabré DeLabré	G5	14.200,00
DC343-G4	•		Copper Rame	Orbitale DeLabré DeLabré orbitale	G4	14.550,00
DC343-G6	•		Copper Rame	Striped DeLabré DeLabré striato	G6	15.100,00

 102 kg

 125 kg

 W. 93 D. 58 H. 192 cm

 1,04 m³

 1

Excluding VAT
IVA esclusa

Celato floor Console

DESIGN BY R&D DE CASTELLI

Free-standing console clad in metal on all sides with invisible drawers with push-pull opening.
 Consolle da terra rivestita in metallo su tutti i lati con cassetti invisibili con apertura push-pull.

Celato floor Console
DC349

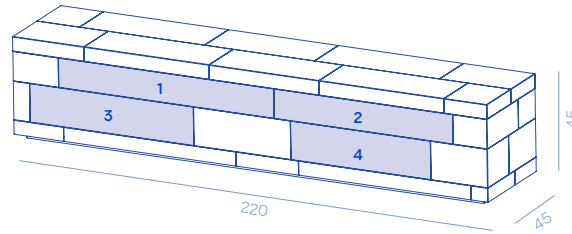

Internal drawers measures
 Misure interne cassetti

DRAWER CASSETTO	DIMENSIONS DIMENSIONI
1	W. 96 D. 36 H. 8,5 cm
2	W. 79 D. 36 H. 8,5 cm
3	W. 71,5 D. 36 H. 8,5 cm
4	W. 60 D. 36 H. 8,5 cm

All drawers open independently of each other.

Tutti i cassetti si aprono indipendentemente gli uni dagli altri.

METAL FINISHES

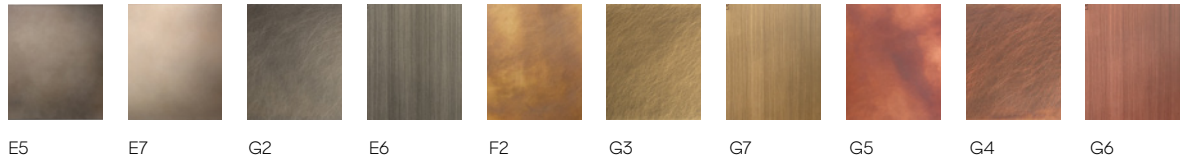

PRODUCT SPECIFICATION

Structure	Natural birch wood 
Assembly	Shipped assembled
Packaging	Wooden crate included TYPE A
Details	<ul style="list-style-type: none"> - Clad in metal on all sides - Hidden drawers as per drawings - Push and pull opening with full-estention Movento slides by Blum

SPECIFICHE PRODOTTO

Struttura	Legno di betulla naturale 
Assemblaggio	Spedito montato
Imballo	Imballo in cassa incluso TIPO A
Dettagli	<ul style="list-style-type: none"> - Rivestito in metallo su tutti i lati - Cassetti nascosti come da disegno - Apertura push and pull con guide Movento di Blum ad estrazione totale

ON REQUEST

Finishes	<ul style="list-style-type: none"> - The product can also be made upon request, subject to confirmation of feasibility by De Castelli - Price is on request
Dimensions	<ul style="list-style-type: none"> - The product can also be made in dimensions on request, subject to confirmation of feasibility by De Castelli - For custom made products please specify the number of drawers as well as the dimensions, material and finishing - Price is on request

SU RICHIESTA

Finiture	<ul style="list-style-type: none"> - Il prodotto può essere realizzato anche in finiture su richiesta, previa conferma fattibilità da parte di De Castelli - Il prezzo è su richiesta
Dimensioni	<ul style="list-style-type: none"> - Il prodotto può essere realizzato anche in dimensioni su richiesta, previa conferma fattibilità da parte di De Castelli - In fase di richiesta specificare oltre al numero di cassetti, le dimensioni, il materiale e la finitura - Il prezzo è su richiesta

CELATO 220 FLOOR CONSOLE

W. 220 D. 45 H. 45 cm

CODE / CODICE	IN	OUT	METAL FINISHES			EURO
DC349-E5	•		Stainless steel Acciaio inox	DeLabré B DeLabré B	E5	10.350,00
DC349-E7	•		Stainless steel Acciaio inox	DeDarié DeDarié	E7	10.450,00
DC349-G2	•		Stainless steel Acciaio inox	Orbitale DeLabré DeLabré orbitale	G2	10.600,00
DC349-E6	•		Stainless steel Acciaio inox	Striped DeLabré DeLabré striato	E6	11.000,00
DC349-F2	•		Brass Ottone	DeLabré DeLabré	F2	11.600,00
DC349-G3	•		Brass Ottone	Orbitale DeLabré DeLabré orbitale	G3	11.880,00
DC349-G7	•		Brass Ottone	Striped DeLabré DeLabré striato	G7	12.100,00
DC349-G5	•		Copper Rame	DeLabré DeLabré	G5	12.550,00
DC349-G4	•		Copper Rame	Orbitale DeLabré DeLabré orbitale	G4	12.880,00
DC349-G6	•		Copper Rame	Striped DeLabré DeLabré striato	G6	13.500,00

 139 kg

 170 kg

 W. 239 D. 64 H. 77 cm

 1,18 m³

 1

Excluding VAT
IVA esclusa

Celato wall-mounted Console

DESIGN BY R&D DE CASTELLI

Wall-mounted console clad in metal on all sides, back excluded, with invisible drawers with push-pull opening.
 Consolle sospesa da parete rivestita in metallo su tutti i lati, schienale escluso, con cassetti invisibili ad apertura push-pull.

Celato Wall mounted Console
DC348

Internal drawers measures
 Misure interne cassetti

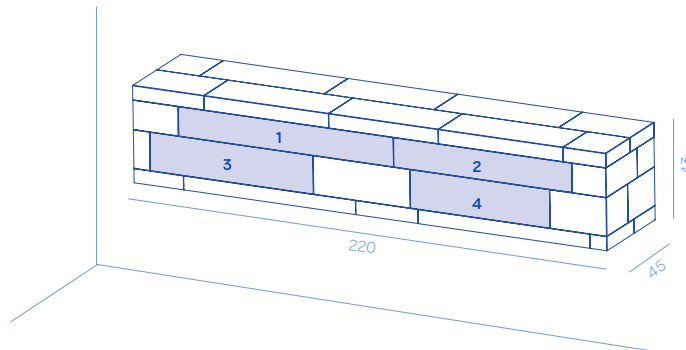

DRAWER CASSETTO	DIMENSIONS DIMENSIONI
1	W. 96 D. 36 H. 8,5 cm
2	W. 79 D. 36 H. 8,5 cm
3	W. 71,5 D. 36 H. 8,5 cm
4	W. 60 D. 36 H. 8,5 cm

All drawers open independently of each other.

Tutti i cassetti si aprono indipendentemente gli uni dagli altri.

METAL FINISHES

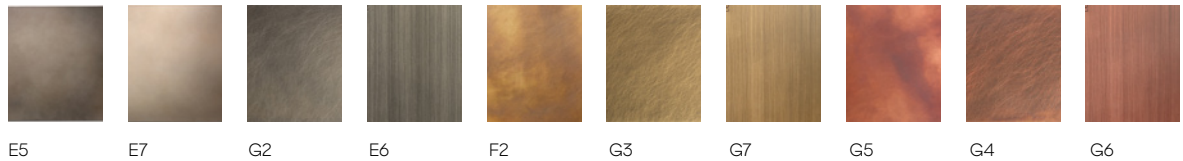

PRODUCT SPECIFICATION

Structure	Natural oak wood 
Assembly	Shelves shipped assembled
Packaging	Wooden crate included TYPE A
Details	<ul style="list-style-type: none"> - Clad in metal on all sides, back excluded - Hidden drawers as per drawings - Push and pull opening with full-extension Movento slides by Blum - Load-bearing wall or reinforced plasterboard is required - Wall fixing system included, fixing screws excluded

SPECIFICHE PRODOTTO

Struttura	Legno di betulla naturale 
Assemblaggio	Spedito montato
Imballo	Imballo in cassa incluso TIPO A
Dettagli	<ul style="list-style-type: none"> - Rivestito in metallo su tutti i lati, schienale escluso - Cassetti nascosti come da disegno - Apertura push and pull con guide Movento di Blum ad estrazione totale - È necessaria una parete portante o un cartongesso rinforzato - Sistema di fissaggio a parete incluso, viti di fissaggio escluse

ON REQUEST

Finishes	<ul style="list-style-type: none"> - The product can also be made upon request, subject to confirmation of feasibility by De Castelli - Price is on request
Dimensions	<ul style="list-style-type: none"> - The product can also be made in dimensions on request, subject to confirmation of feasibility by De Castelli - For custom made products please specify the number of drawers as well as the dimensions, material and finishing - Price is on request

SU RICHIESTA

Finiture	<ul style="list-style-type: none"> - Il prodotto può essere realizzato anche in finiture su richiesta, previa conferma fattibilità da parte di De Castelli - Il prezzo è su richiesta
Dimensioni	<ul style="list-style-type: none"> - Il prodotto può essere realizzato anche in dimensioni su richiesta, previa conferma fattibilità da parte di De Castelli - In fase di richiesta specificare oltre al numero di cassetti, le dimensioni, il materiale e la finitura - Il prezzo è su richiesta

CELATO 220 WALL-MOUNTED CONSOLE

W. 220 D. 45 H. 43 cm

CODE / CODICE	IN	OUT	METAL FINISHES / MATERIALI E FINITURE			EURO
DC348-E5	•		Stainless steel Acciaio inox	DeLabré B DeLabré B	E5	10.500,00
DC348-E7	•		Stainless steel Acciaio inox	DeDarié DeDarié	E7	10.600,00
DC348-G2	•		Stainless steel Acciaio inox	Orbitale DeLabré DeLabré orbitale	G2	10.750,00
DC348-E6	•		Stainless steel Acciaio inox	Striped DeLabré DeLabré striato	E6	11.150,00
DC348-F2	•		Brass Ottone	DeLabré DeLabré	F2	12.100,00
DC348-G3	•		Brass Ottone	Orbitale DeLabré DeLabré orbitale	G3	12.350,00
DC348-G7	•		Brass Ottone	Striped DeLabré DeLabré striato	G7	12.600,00
DC348-G5	•		Copper Rame	DeLabré DeLabré	G5	12.500,00
DC348-G4	•		Copper Rame	Orbitale DeLabré DeLabré orbitale	G4	14.000,00
DC348-G6	•		Copper Rame	Striped DeLabré DeLabré striato	G6	14.550,00

 139 kg

 165 kg

 W. 240 D. 65 H. 77 cm

 1,20 m³

 1

Excluding VAT
IVA esclusa

Elizabeth Console

DESIGN BY NATHALIE DEWEZ

Console clad in pleated metal on all sides with 2 push and pull opening doors.

Consolle rivestita in metallo plissettato su tutti i lati con 2 ante con apertura push and pull.

Elizabeth Console
DC541

Closed / Chiuso

Open / Aperto

Internal measurements / Misure interne

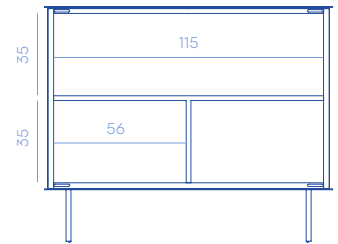
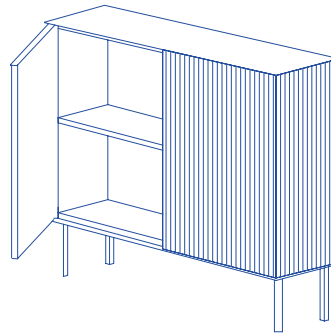
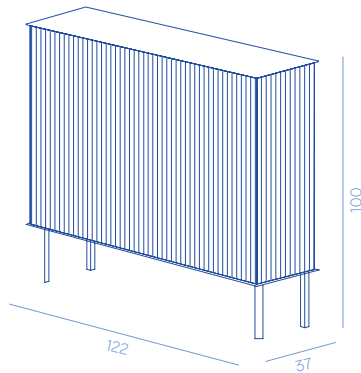

METAL FINISHES



D2



M14



M13

PRODUCT SPECIFICATION

Structure	Matt lacquered RAL 7013 wood 
Assembly	Shipped assembled
Packaging	Wooden crate included TYPE A
Details	<ul style="list-style-type: none"> - Clad in pleated metal on all sides - Two push and pull opening doors - Fixed shelf and divider

SPECIFICHE PRODOTTO

Struttura	Matt lacquered RAL 7013 wood 
Assemblaggio	Spedito montato
Imballo	Imballo in cassa incluso TIPO A
Dettagli	<ul style="list-style-type: none"> - Rivestito in metallo plissettato su tutti i lati - Due ante con apertura push and pull - Ripiano e divisorio fissi

ON REQUEST

Finishes	The product is available only in the finishes listed
Dimensions	<ul style="list-style-type: none"> - The product may undergo small changes limited to the length, subject to confirmation of feasibility by De Castelli - It is not recommended to decrease the depth and to change the height - For custom made products please specify the dimensions, material and finishing - Price is on request

SU RICHIESTA

Finiture	Il prodotto è disponibile nelle sole finiture presenti
Dimensioni	<ul style="list-style-type: none"> - Il prodotto può subire piccole modifiche limitatamente alla lunghezza, previa conferma fattibilità da parte di De Castelli - È sconsigliato diminuire la profondità e cambiare l'altezza - In fase di richiesta specificare le dimensioni, il materiale e la finitura - Il prezzo è su richiesta

ELIZABETH CONSOLE

W. 122 D. 37 H. 100 cm

CODE / CODICE	IN	OUT	METAL FINISHES / MATERIALI E FINITURE			EURO
DC541-D2	•		Stainless steel Acciaio inox	Polished Lucido	D2	12.000,00
DC541-M14	•		Brass Ottone	Polished Lucido	M14	16.000,00
DC541-M13	•		Copper Rame	Polished Lucido	M13	17.400,00

 90 kg

 110 kg

 W. 160 D. 90 H. 132 cm

 1,90 m³

 1

Excluding VAT
IVA esclusa

Elizabeth Sideboard

DESIGN BY NATHALIE DEWEZ

Sideboard clad in pleated metal on all sides with push and pull opening doors.

Credenza rivestita in metallo plissettato su tutti i lati con ante con apertura push and pull.

Elizabeth sideboard 92
DC716
2 doors

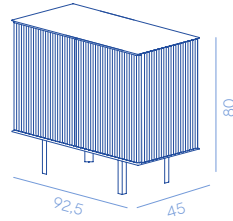

Elizabeth sideboard 273
DC718
6 doors

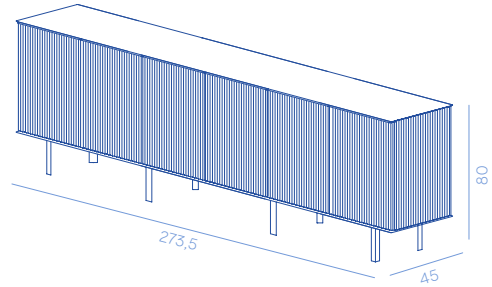

Elizabeth sideboard 183
DC717
4 doors

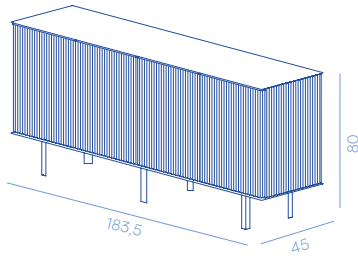

Internal measurements / Misure interne

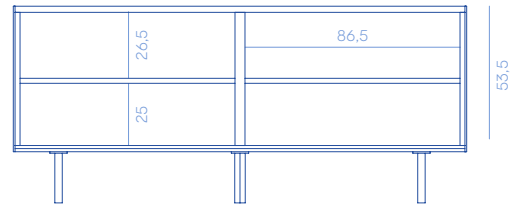

METAL FINISHES



D2

M14

M13

PRODUCT SPECIFICATION

Structure	Matt lacquered RAL 7013 wood
Assembly	Shipped assembled
Packaging	Wooden crate included TYPE A
Details	<ul style="list-style-type: none"> - Clad in pleated metal on all sides - Push and pull opening doors - Movable shelves

SPECIFICHE PRODOTTO

Struttura	Matt lacquered RAL 7013 wood
Assemblaggio	Spedito montato
Imballo	Imballo in cassa incluso TIPO A
Dettagli	<ul style="list-style-type: none"> - Rivestito in metallo plissettato su tutti i lati - Due ante con apertura push and pull - Ripiani amovibili

ON REQUEST

Finishes	The product is available only in the finishes listed
Dimensions	<ul style="list-style-type: none"> - The product may undergo small changes limited to the length, subject to confirmation of feasibility by De Castelli - It is not recommended to decrease the depth and to change the height - For custom made products please the dimensions, material and finishing - Price is on request

SU RICHIESTA

Finiture	Il prodotto è disponibile nelle sole finiture previste
Dimensioni	<ul style="list-style-type: none"> - Il prodotto può subire piccole modifiche limitatamente alla lunghezza, previa conferma fattibilità da parte di De Castelli - È sconsigliato diminuire la profondità e cambiare l'altezza - In fase di richiesta specificare le dimensioni, il materiale e la finitura - Il prezzo è su richiesta

ELIZABETH 92 SIDEBOARD - 2 DOORS

W. 92,5 D. 45 H. 80 cm

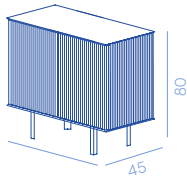

CODE / CODICE	IN	OUT	METAL FINISHES / MATERIALI E FINITURE			EURO
DC716-D2	•		Stainless steel Acciaio inox	Polished Lucido	D2	11.000,00
DC716-M14	•		Brass Ottone	Polished Lucido	M14	15.000,00
DC716-M13	•		Copper Rame	Polished Lucido	M13	16.000,00

kg 90 kg
 kg 140 kg
 cm W. 113 D. 65 H. 112 cm
 m³ 0,82 m³
 N° 1
 Excluding VAT IVA esclusa

ELIZABETH 183 SIDEBOARD - 4 DOORS

W. 183,5 D. 45 H. 80 cm

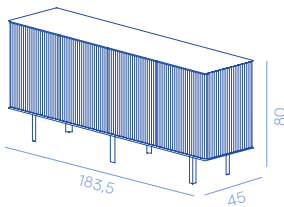

CODE / CODICE	IN	OUT	METAL FINISHES			EURO
DC717-D2	•		Stainless steel Acciaio inox	Polished Lucido	D2	15.000,00
DC717-M14	•		Brass Ottone	Polished Lucido	M14	16.000,00
DC717-M13	•		Copper Rame	Polished Lucido	M13	17.000,00

kg 180 kg
 kg 230 kg
 cm W. 204 D. 65 H. 112 cm
 m³ 1,50 m³
 N° 1
 Excluding VAT IVA esclusa

ELIZABETH 173 SIDEBOARD - 6 DOORS

W. 273,5 D. 45 H. 80 cm

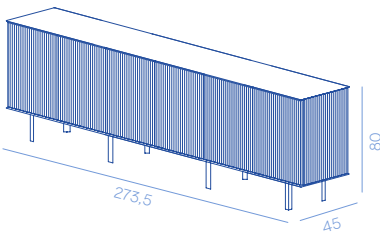

CODE / CODICE	IN	OUT	METAL FINISHES			EURO
DC718-D2	•		Stainless steel Acciaio inox	Polished Lucido	D2	20.000,00
DC718-M14	•		Brass Ottone	Polished Lucido	M14	21.000,00
DC718-M13	•		Copper Rame	Polished Lucido	M13	22.000,00

kg 270 kg
 kg 320 kg
 cm W. 294 D. 65 H. 112 cm
 m³ 2,14 m³
 N° 1
 Excluding VAT IVA esclusa

Graffio

DESIGN BY ADRIANO DESIGN

2 doors cabinet clad in metal on all sides, back excluded. Doors are equipped with 3 shelves each and related bottle holders. Internally equipped with fixed shelves and divider.

Mobile a 2 ante rivestito in metallo su tutti i lati, schienale escluso. Le ante sono dotate di 3 ripiani ciascuna e relativi portabottiglie. Internamente attrezzato con ripiani fissi e divisorio.

Graffio
DC639

Open / Aperto

Internal measurements / Misure interne

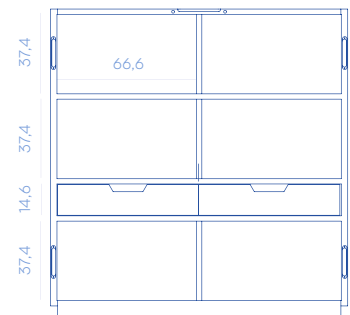
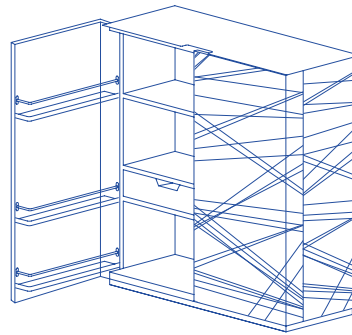
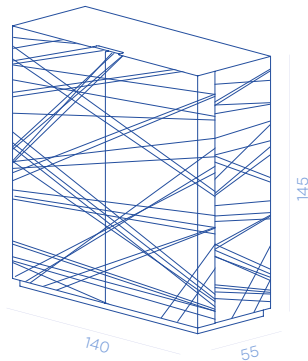

METAL FINISHES

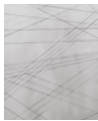

IX-H10

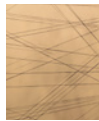

OT-H10

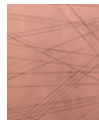

RA-H10

PRODUCT SPECIFICATION

Structure	Natural oak wood 
Assembly	Shipped assembled
Packaging	Wooden crate included TYPE A
Details	<ul style="list-style-type: none"> - Clad in metal on all sides, back excluded - Two pull opening doors equipped with three shelves and three bottle holders each - Two fixed shelves - Two inner drawers with pull opening with full-extension Blumotion Movento slides by Blum

ON REQUEST

Finishes	<ul style="list-style-type: none"> - The product can also be made upon request, subject to confirmation of feasibility by De Castelli - Price is on request
Dimensions	The product is available only in the dimensions listed

SPECIFICHE PRODOTTO

Struttura	Legno rovere naturale 
Assemblaggio	Spedito montato
Imballo	Imballo in cassa incluso TIPO A
Dettagli	<ul style="list-style-type: none"> - Rivestito in metallo su tutti i lati, schienale escluso - Due ante con apertura a tirare dotate di tre ripiani e tre portabottiglie ciascuno - Due ripiani fissi - Due cassetti interni con apertura a tirare con guide Blumotion Movento ad estrazione totale di Blum

SU RICHIESTA

Finiture	<ul style="list-style-type: none"> - Il prodotto può essere realizzato anche in finiture su richiesta, previa conferma fattibilità da parte di De Castelli - Il prezzo è su richiesta
Dimensioni	Il prodotto è disponibile solo nelle dimensioni previste

GRAFFIO

W. 140 D. 55 H. 145 cm

CODE / CODICE	IN	OUT	METAL FINISHES			EURO
DC639-IX-H10	•		Stainless steel Acciaio inox	DeErosion DeErosion	H10	17.000,00
DC639-OT-H10	•		Brass Ottone	DeErosion DeErosion	H10	18.500,00
DC639-RA-H10	•		Copper Rame	DeErosion DeErosion	H10	19.500,00

 160 kg

 185 kg

 W. 160 D. 75 H. 177 cm

 2,12 m³

 1

Excluding VAT
IVA esclusa

Longing Cabinet

DESIGN BY NIKA ZUPANC

Cabinet with 16 small doors with keys opening, clad in metal with different finishes on all sides.

Cabinet con 16 piccole ante con apertura a chiave, rivestito in metallo con diverse finiture su tutti i lati.

Longing Cabinet
DC551

Internal measurements / Misure interne

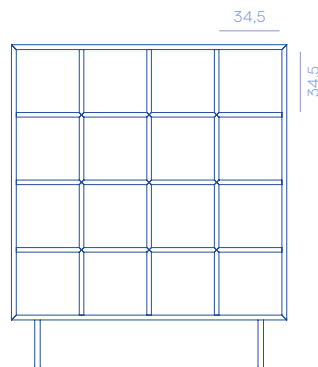
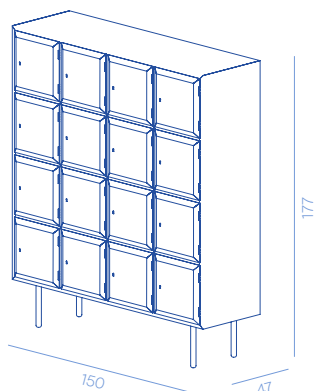

METAL FINISHES



MIX-OT (M9+E13+G3)

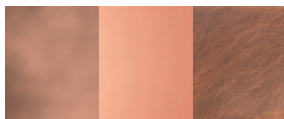

MIX-RA (M10+E14+G4)

PRODUCT SPECIFICATION

Structure	Matt lacquered RAL 3012 wood
Assembly	Shipped assembled
Packaging	Wooden crate included TYPE A
Details	<ul style="list-style-type: none"> – Clad in metal on all sides in different finishes as per photo – Sixteen doors opening equipped with keys made of cast brass

SPECIFICHE PRODOTTO

Struttura	Legno laccato opaco RAL 3012
Assemblaggio	Spedito montato
Imballo	Imballo in cassa incluso TIPO A
Dettagli	<ul style="list-style-type: none"> – Rivestito in metallo su tutti i lati in diverse finiture come da foto – Apertura di sedici ante dotate di chiavi in fusione di ottone

ON REQUEST

Finishes	<ul style="list-style-type: none"> – The product can also be made upon request, subject to confirmation of feasibility by De Castelli – Price is on request
Dimensions	<ul style="list-style-type: none"> – The product can also be made in dimensions on request, subject to confirmation of feasibility by De Castelli – For custom made products please specify the number of doors as well as the dimensions, material and finishing – Price is on request

SU RICHIESTA

Finiture	<ul style="list-style-type: none"> – Il prodotto può essere realizzato anche in finiture su richiesta, previa conferma fattibilità da parte di De Castelli – Il prezzo è su richiesta
Dimensioni	<ul style="list-style-type: none"> – Il prodotto può essere realizzato anche in dimensioni su richiesta, previa conferma fattibilità da parte di De Castelli – In fase di richiesta specificare oltre al numero di ante, le dimensioni, il materiale e la finitura – Il prezzo è su richiesta

LONGING CABINET

W. 150 D. 47 H. 177 cm

CODE / CODICE	IN	OUT	METAL FINISHES		EURO
DC551-OT	•		Brass Ottone	Mix Mix	OT 27.000,00
DC551-RA	•		Copper Rame	Mix Mix	RA 28.400,00

 120 kg

 145 kg

 W. 170 D. 60 H. 212 cm

 2,16 m³

 1

Excluding VAT
IVA esclusa

Marea Cabinet

DESIGN BY ZANELLATO/BORTOTTO

2 doors cabinet with push and pull opening, clad in metal on all sides.

Mobile a 2 ante con apertura push and pull, rivestito in metallo su tutti i lati.

Marea Cabinet
DC605

Internal measurements / Misure interne

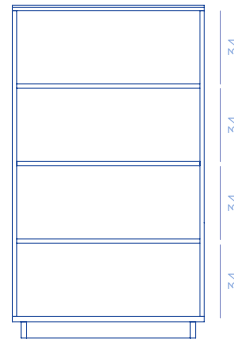
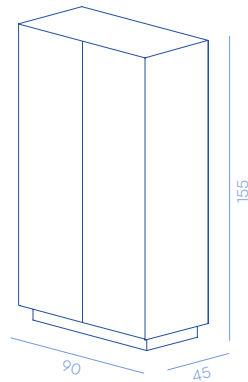

METAL FINISHES

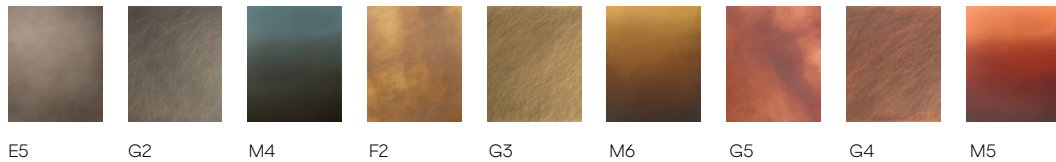

PRODUCT SPECIFICATION

Structure	Titanium oak wood 
Assembly	Shelves shipped disassembled
Packaging	Wooden crate included TYPE A
Details	<ul style="list-style-type: none"> - Clad in metal on all sides - Push and pull doors opening - Equipped with a central fixed shelf and two movable shelves - Inside door-straightener included

SPECIFICHE PRODOTTO

Struttura	Legno rovere titanio 
Assemblaggio	Mensole spedite smontate
Imballo	Imballo in cassa inclusa TIPO A
Dettagli	<ul style="list-style-type: none"> - Rivestito in metallo su tutti i lati - Ante con apertura push and pull - Dotato di un ripiano centrale fisso e due ripiani mobili - Barre raddrizzanti nelle ante incluse

ON REQUEST

Finishes	<ul style="list-style-type: none"> - The product can also be made upon request, subject to confirmation of feasibility by De Castelli - Price is on request
Dimensions	<ul style="list-style-type: none"> - The product can also be made in dimensions on request, subject to confirmation of feasibility by De Castelli - For custom made products please specify the number of doors and shelves as well as the dimensions, material and finishing - Price is on request

SU RICHIESTA

Finiture	<ul style="list-style-type: none"> - Il prodotto può essere realizzato anche in finiture su richiesta, previa conferma fattibilità da parte di De Castelli - Il prezzo è su richiesta
Dimensioni	<ul style="list-style-type: none"> - Il prodotto può essere realizzato anche in dimensioni su richiesta, previa conferma fattibilità da parte di De Castelli - In fase di richiesta specificare oltre al numero di ante e di mensole, le dimensioni, il materiale e la finitura - Il prezzo è su richiesta

MAREA CABINET

W. 90 D. 45 H. 155 cm

CODE / CODICE	IN	OUT	METAL FINISHES			EURO
DC605-E5	•		Stainless steel Acciaio inox	DeLabré B DeLabré B	E5	7.930,00
DC605-G2	•		Stainless steel Acciaio inox	Orbitale DeLabré DeLabré orbitale	G2	8.180,00
DC605-M4	•		Stainless steel Acciaio inox	DeMarea DeMarea	M4	8.780,00
DC605-F2	•		Brass Ottone	DeLabré DeLabré	F2	8.990,00
DC605-G3	•		Brass Ottone	Orbitale DeLabré DeLabré orbitale	G3	10.000,00
DC605-M6	•		Brass Ottone	DeMarea DeMarea	M6	9.880,00
DC605-G5	•		Copper Rame	DeLabré DeLabré	G5	9.890,00
DC605-G4	•		Copper Rame	Orbitale DeLabré DeLabré orbitale	G4	10.150,00
DC605-M5	•		Copper Rame	DeMarea DeMarea	M5	10.800,00

 94 kg

 118 kg

 W. 107 D. 62 H. 191 cm

 1,27 m³

 1

Excluding VAT
IVA esclusa

Marea Chest of drawers

DESIGN BY ZANELLATO/BORTOTTO

Chest of drawers with push and pull opening with full-extension Movento slides by Blum, clad in metal on all sides.

Cassettiera con apertura push and pull con guide ad estrazione totale Movento di Blum, rivestita in metallo su tutti i lati.

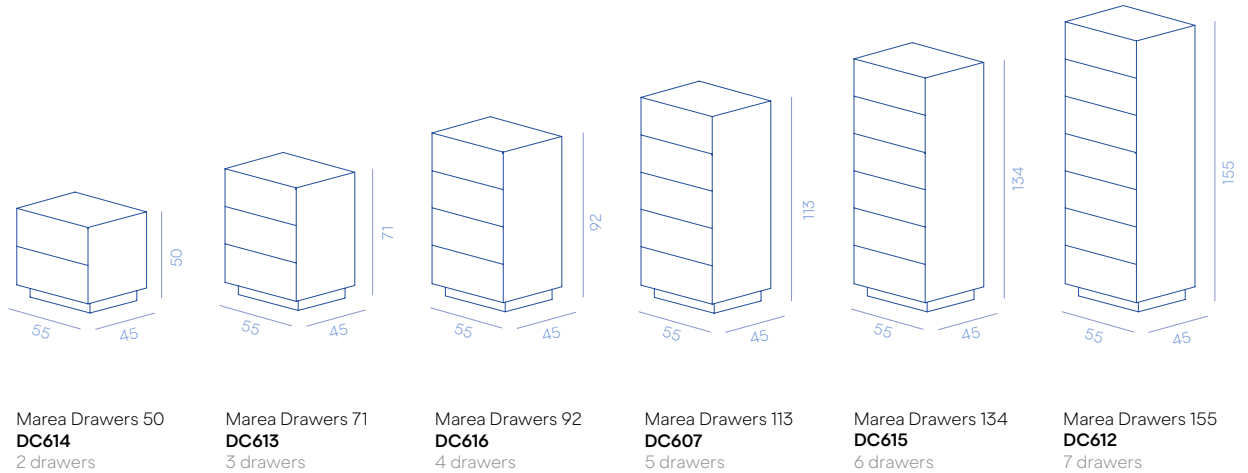

METAL FINISHES

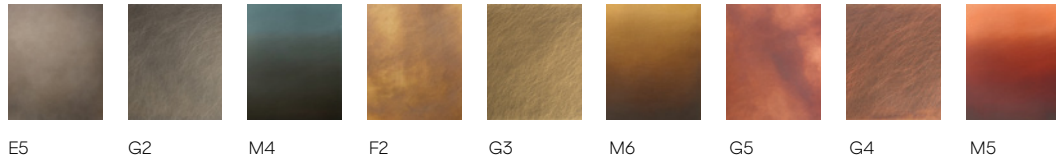

PRODUCT SPECIFICATION

Structure	Titanium oak wood 
Assembly	Shipped assembled
Packaging	Wooden crate included TYPE A
Details	<ul style="list-style-type: none"> – Clad in metal on all sides – Push and pull drawers opening with full-extension Movento slides by Blum

SPECIFICHE PRODOTTO

Struttura	Legno rovere titanio 
Assemblaggio	Spedita montata
Imballo	Imballo in cassa inclusa TIPO A
Dettagli	<ul style="list-style-type: none"> – Rivestita in metallo su tutti i lati – Apertura cassetti push and pull con guide Movento ad estrazione totale di Blum

ON REQUEST

Finishes	<ul style="list-style-type: none"> – The product can also be made upon request, subject to confirmation of feasibility by De Castelli – Price is on request
Dimensions	<ul style="list-style-type: none"> – The product can also be made in dimensions on request, subject to confirmation of feasibility by De Castelli – For custom made products please specify the number of drawers as well as the dimensions, material and finishing – Price is on request

SU RICHIESTA

Finiture	<ul style="list-style-type: none"> – Il prodotto può essere realizzato anche in finiture su richiesta, previa conferma fattibilità da parte di De Castelli – Il prezzo è su richiesta
Dimensioni	<ul style="list-style-type: none"> – Il prodotto può essere realizzato anche in dimensioni su richiesta, previa conferma fattibilità da parte di De Castelli – In fase di richiesta specificare oltre al numero di cassetti, le dimensioni, il materiale e la finitura – Il prezzo è su richiesta

MAREA CHEST OF DRAWERS 50 - 2 DRAWERS

W. 55 D. 45 H. 50 cm

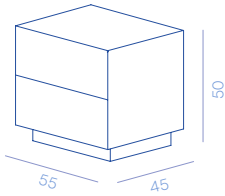

CODE / CODICE	IN	OUT	METAL FINISHES			EURO
DC614-E5	•		Stainless steel Acciaio inox	DeLabré B DeLabré B	E5	5.390,00
DC614-G2	•		Stainless steel Acciaio inox	Orbitale DeLabré DeLabré orbitale	G2	5.450,00
DC614-M4	•		Stainless steel Acciaio inox	DeMarea DeMarea	M4	5.680,00
DC614-F2	•		Brass Ottone	DeLabré DeLabré	F2	5.870,00
DC614-G3	•		Brass Ottone	Orbitale DeLabré DeLabré orbitale	G3	6.120,00
DC614-M6	•		Brass Ottone	DeMarea DeMarea	M6	6.300,00
DC614-G5	•		Copper Rame	DeLabré DeLabré	G5	6.150,00
DC614-G4	•		Copper Rame	Orbitale DeLabré DeLabré orbitale	G4	6.300,00
DC614-M5	•		Copper Rame	DeMarea DeMarea	M5	6.750,00

kg 26 kg

kg 36 kg

cm W. 74 D. 64 H. 82 cm

m³ 0,40 m³

N° 1

Excluding VAT
IVA esclusa

MAREA CHEST OF DRAWERS 71 - 3 DRAWERS

W. 55 D. 45 H. 71 cm

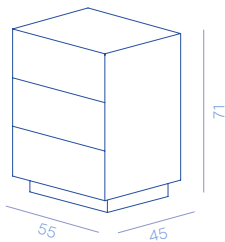

CODE / CODICE	IN	OUT	METAL FINISHES			EURO
DC613-E5	•		Stainless steel Acciaio inox	DeLabré B DeLabré B	E5	7.370,00
DC613-G2	•		Stainless steel Acciaio inox	Orbitale DeLabré DeLabré orbitale	G2	7.510,00
DC613-M4	•		Stainless steel Acciaio inox	DeMarea DeMarea	M4	7.630,00
DC613-F2	•		Brass Ottone	DeLabré DeLabré	F2	8.000,00
DC613-G3	•		Brass Ottone	Orbitale DeLabré DeLabré orbitale	G3	8.300,00
DC613-M6	•		Brass Ottone	DeMarea DeMarea	M6	8.740,00
DC613-G5	•		Copper Rame	DeLabré DeLabré	G5	8.510,00
DC613-G4	•		Copper Rame	Orbitale DeLabré DeLabré orbitale	G4	8.600,00
DC613-M5	•		Copper Rame	DeMarea DeMarea	M5	9.200,00

kg 36 kg

kg 48 kg

cm W. 74 D. 64 H. 103 cm

m³ 0,50 m³

N° 1

Excluding VAT
IVA esclusa

MAREA CHEST OF DRAWERS 92 - 4 DRAWERS

W. 55 D. 45 H. 92 cm

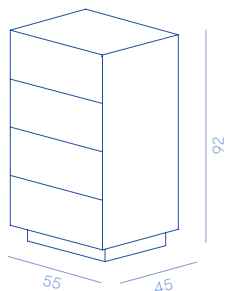

CODE / CODICE	IN	OUT	METAL FINISHES			EURO
DC616-E5	•		Stainless steel Acciaio inox	DeLabré B DeLabré B	E5	9.490,00
DC616-G2	•		Stainless steel Acciaio inox	Orbitale DeLabré DeLabré orbitale	G2	9.640,00
DC616-M4	•		Stainless steel Acciaio inox	DeMarea DeMarea	M4	9.780,00
DC616-F2	•		Brass Ottone	DeLabré DeLabré	F2	10.440,00
DC616-G3	•		Brass Ottone	Orbitale DeLabré DeLabré orbitale	G3	10.780,00
DC616-M6	•		Brass Ottone	DeMarea DeMarea	M6	10.920,00
DC616-G5	•		Copper Rame	DeLabré DeLabré	G5	11.070,00
DC616-G4	•		Copper Rame	Orbitale DeLabré DeLabré orbitale	G4	11.140,00
DC616-M5	•		Copper Rame	DeMarea DeMarea	M5	11.370,00

kg 46 kg

kg 56 kg

cm W. 74 D. 64 H. 124 cm

m³ 0,59 m³

N° 1

Excluding VAT
IVA esclusa

MAREA CHEST OF DRAWERS 113 - 5 DRAWERS

W. 55 D. 45 H. 113 cm

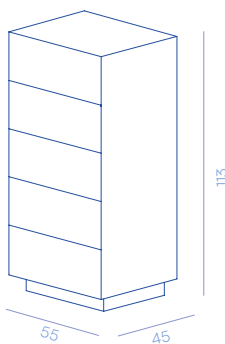

CODE / CODICE	IN	OUT	METAL FINISHES			EURO
DC607-E5	•		Stainless steel Acciaio inox	DeLabré B DeLabré B	E5	11.300,00
DC607-G2	•		Stainless steel Acciaio inox	Orbitale DeLabré DeLabré orbitale	G2	11.440,00
DC607-M4	•		Stainless steel Acciaio inox	DeMarea DeMarea	M4	11.600,00
DC607-F2	•		Brass Ottone	DeLabré DeLabré	F2	12.600,00
DC607-G3	•		Brass Ottone	Orbitale DeLabré DeLabré orbitale	G3	12.730,00
DC607-M6	•		Brass Ottone	DeMarea DeMarea	M6	13.200,00
DC607-G5	•		Copper Rame	DeLabré DeLabré	G5	13.400,00
DC607-G4	•		Copper Rame	Orbitale DeLabré DeLabré orbitale	G4	13.900,00
DC607-M5	•		Copper Rame	DeMarea DeMarea	M5	13.600,00

kg 63 kg

kg 81 kg

cm W. 74 D. 64 H. 145 cm

m³ 0,69 m³

N° 1

Excluding VAT
IVA esclusa

MAREA CHEST OF DRAWERS 134 - 6 DRAWERS

W. 55 D. 45 H. 134 cm

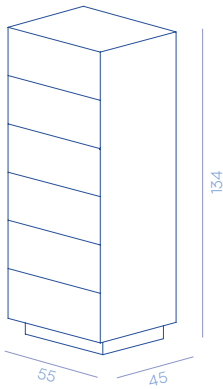

CODE / CODICE	IN	OUT	METAL FINISHES			EURO
DC615-E5	•		Stainless steel Acciaio inox	DeLabré B DeLabré B	E5	13.500,00
DC615-G2	•		Stainless steel Acciaio inox	Orbitale DeLabré DeLabré orbitale	G2	13.630,00
DC615-M4	•		Stainless steel Acciaio inox	DeMarea DeMarea	M4	13.800,00
DC615-F2	•		Brass Ottone	DeLabré DeLabré	F2	14.750,00
DC615-G3	•		Brass Ottone	Orbitale DeLabré DeLabré orbitale	G3	14.890,00
DC615-M6	•		Brass Ottone	DeMarea DeMarea	M6	15.500,00
DC615-G5	•		Copper Rame	DeLabré DeLabré	G5	15.500,00
DC615-G4	•		Copper Rame	Orbitale DeLabré DeLabré orbitale	G4	16.850,00
DC615-M5	•		Copper Rame	DeMarea DeMarea	M5	17.500,00

kg 76 kg

kg 96 kg

cm W. 74 D. 64 H. 166 cm

m³ 0,79 m³

N° 1

Excluding VAT
IVA esclusa

MAREA CHEST OF DRAWERS 155 - 7 DRAWERS

W. 55 D. 45 H. 155 cm

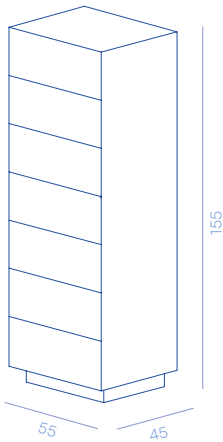

CODE / CODICE	IN	OUT	METAL FINISHES			EURO
DC612-E5	•		Stainless steel Acciaio inox	DeLabré B DeLabré B	E5	15.290,00
DC612-G2	•		Stainless steel Acciaio inox	Orbitale DeLabré DeLabré orbitale	G2	15.430,00
DC612-M4	•		Stainless steel Acciaio inox	DeMarea DeMarea	M4	15.700,00
DC612-F2	•		Brass Ottone	DeLabré DeLabré	F2	16.250,00
DC612-G3	•		Brass Ottone	Orbitale DeLabré DeLabré orbitale	G3	16.850,00
DC612-M6	•		Brass Ottone	DeMarea DeMarea	M6	17.270,00
DC612-G5	•		Copper Rame	DeLabré DeLabré	G5	17.270,00
DC612-G4	•		Copper Rame	Orbitale DeLabré DeLabré orbitale	G4	17.550,00
DC612-M5	•		Copper Rame	DeMarea DeMarea	M5	18.120,00

kg 90 kg

kg 112 kg

cm W. 74 D. 64 H. 187 cm

m³ 0,89 m³

N° 1

Excluding VAT
IVA esclusa

Marea Dresser

DESIGN BY ZANELLATO/BORTOTTO

Dresser with push and pull opening with full-extension Movento slides by Blum, clad in metal on all sides.

Credenza a cassettoni con apertura push and pull con guide ad estrazione totale Movento di Blum, rivestita in metallo su tutti i lati.

Marea Dresser 96
DC643
3 drawers

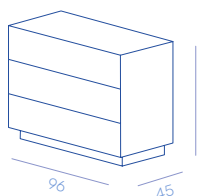

Marea Dresser 190
DC644
6 drawers

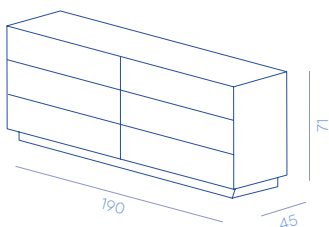

Marea Dresser 285
DC645
9 drawers

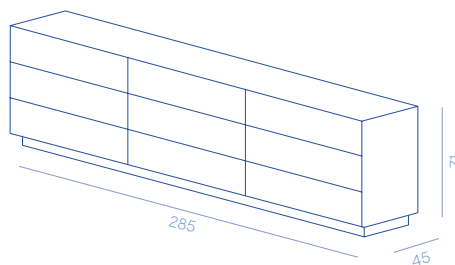

METAL FINISHES

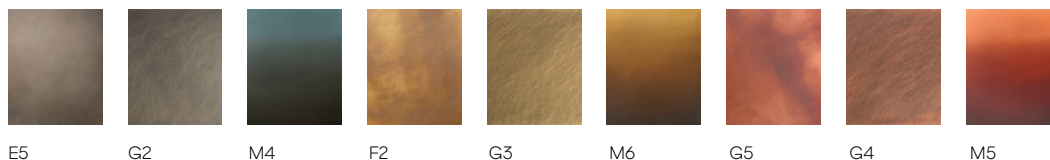

E5

G2

M4

F2

G3

M6

G5

G4

M5

PRODUCT SPECIFICATION

Structure	Titanium oak wood 
Assembly	Shipped assembled
Packaging	Wooden crate included TYPE A
Details	<ul style="list-style-type: none"> – Clad in metal on all sides – Push and pull drawers opening with full-extension Movento slides by Blum

SPECIFICHE PRODOTTO

Struttura	Legno rovere titanio 
Assemblaggio	Spedita montata
Imballo	Imballo in cassa inclusa TIPO A
Dettagli	<ul style="list-style-type: none"> – Rivestita in metallo su tutti i lati – Apertura cassetti push and pull con guide Movento ad estrazione totale di Blum

ON REQUEST

Finishes	<ul style="list-style-type: none"> – The product can also be made upon request, subject to confirmation of feasibility by De Castelli – Price is on request
Dimensions	<ul style="list-style-type: none"> – The product can also be made in dimensions on request, subject to confirmation of feasibility by De Castelli – For custom made products please specify the number of drawers as well as the dimensions, material and finishing – Price is on request

SU RICHIESTA

Finiture	<ul style="list-style-type: none"> – Il prodotto può essere realizzato anche in finiture su richiesta, previa conferma fattibilità da parte di De Castelli – Il prezzo è su richiesta
Dimensioni	<ul style="list-style-type: none"> – Il prodotto può essere realizzato anche in dimensioni su richiesta, previa conferma fattibilità da parte di De Castelli – In fase di richiesta specificare oltre al numero di cassetti, le dimensioni, il materiale e la finitura – Il prezzo è su richiesta

MAREA DRESSER 96 - 3 DRAWERS

W. 96 D. 45 H. 71 cm

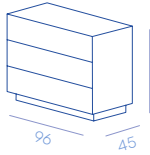

CODE / CODICE	IN	OUT	METAL FINISHES			EURO
DC643-E5	•		Stainless steel Acciaio inox	DeLabré B DeLabré B	E5	10.100,00
DC643-G2	•		Stainless steel Acciaio inox	Orbitale DeLabré DeLabré orbitale	G2	10.240,00
DC643-M4	•		Stainless steel Acciaio inox	DeMarea DeMarea	M4	10.400,00
DC643-F2	•		Brass Ottone	DeLabré DeLabré	F2	11.020,00
DC643-G3	•		Brass Ottone	Orbitale DeLabré DeLabré orbitale	G3	11.160,00
DC643-M6	•		Brass Ottone	DeMarea DeMarea	M6	11.500,00
DC643-G5	•		Copper Rame	DeLabré DeLabré	G5	11.960,00
DC643-G4	•		Copper Rame	Orbitale DeLabré DeLabré orbitale	G4	12.110,00
DC643-M5	•		Copper Rame	DeMarea DeMarea	M5	12.400,00

kg 60 kg

kg 110 kg

cm W. 116 D. 65 H. 93 cm

m³ 0,70 m³

N° 1

Excluding VAT
IVA esclusa

MAREA DRESSER 190 - 6 DRAWERS

W. 190 D. 45 H. 71 cm

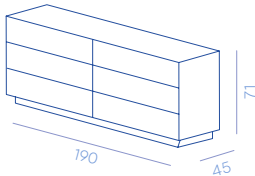

CODE / CODICE	IN	OUT	METAL FINISHES			EURO
DC644-E5	•		Stainless steel Acciaio inox	DeLabré B DeLabré B	E5	18.750,00
DC644-G2	•		Stainless steel Acciaio inox	Orbitale DeLabré DeLabré orbitale	G2	19.150,00
DC644-M4	•		Stainless steel Acciaio inox	DeMarea DeMarea	M4	19.800,00
DC644-F2	•		Brass Ottone	DeLabré DeLabré	F2	20.420,00
DC644-G3	•		Brass Ottone	Orbitale DeLabré DeLabré orbitale	G3	20.550,00
DC644-M6	•		Brass Ottone	DeMarea DeMarea	M6	20.820,00
DC644-G5	•		Copper Rame	DeLabré DeLabré	G5	20.820,00
DC644-G4	•		Copper Rame	Orbitale DeLabré DeLabré orbitale	G4	21.100,00
DC644-M5	•		Copper Rame	DeMarea DeMarea	M5	21.400,00

kg 115 kg

kg 165 kg

cm W. 210 D. 65 H. 93 cm

m³ 1,27 m³

N° 1

Excluding VAT
IVA esclusa

MAREA DRESSER 285 - 9 DRAWERS

W. 285 D. 45 H. 71 cm

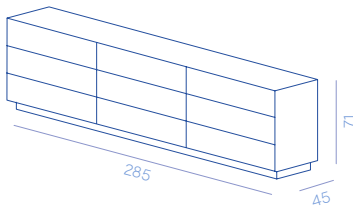

CODE / CODICE	IN	OUT	METAL FINISHES			EURO
DC645-E5	•		Stainless steel Acciaio inox	DeLabré B DeLabré B	E5	26.000,00
DC645-G2	•		Stainless steel Acciaio inox	Orbitale DeLabré DeLabré orbitale	G2	27.000,00
DC645-M4	•		Stainless steel Acciaio inox	DeMarea DeMarea	M4	27.700,00
DC645-F2	•		Brass Ottone	DeLabré DeLabré	F2	27.800,00
DC645-G3	•		Brass Ottone	Orbitale DeLabré DeLabré orbitale	G3	28.000,00
DC645-M6	•		Brass Ottone	DeMarea DeMarea	M6	28.500,00
DC645-G5	•		Copper Rame	DeLabré DeLabré	G5	20.500,00
DC645-G4	•		Copper Rame	Orbitale DeLabré DeLabré orbitale	G4	28.500,00
DC645-M5	•		Copper Rame	DeMarea DeMarea	M5	29.300,00

kg 170 kg

kg 220 kg

cm W. 305 D. 65 H. 93 cm

m³ 1,84 m³

N° 1

Excluding VAT
IVA esclusa

Marea Sideboard

DESIGN BY ZANELLATO/BORTOTTO

Sideboard with push and pull opening, clad in metal on all sides.

Credenza con apertura push and pull, rivestita in metallo su tutti i lati.

METAL FINISHES

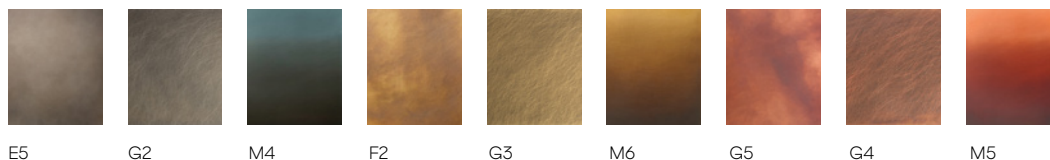

PRODUCT SPECIFICATION

Structure	Titanium oak wood 
Assembly	Shelf shipped disassembled
Packaging	Wooden crate included TYPE A
Details	<ul style="list-style-type: none">- Clad in metal on all sides- Push and pull doors opening- Equipped with 1 movable shelf per each module of 2 doors

ON REQUEST

Finishes	<ul style="list-style-type: none">- The product can also be made upon request, subject to confirmation of feasibility by De Castelli- Price is on request
Dimensions	<ul style="list-style-type: none">- The product can also be made in dimensions on request, subject to confirmation of feasibility by De Castelli- For custom made products please specify the number of doors and shelves as well as the dimensions, material and finishing- Price is on request

SPECIFICHE PRODOTTO

Struttura	Legno rovere titanio 
Assemblaggio	Mensola spedita smontata
Imballo	Imballo in cassa inclusa TIPO A
Dettagli	<ul style="list-style-type: none">- Rivestita in metallo su tutti i lati- Ante con apertura push and pull- Dotata di un ripiano amovibile per ogni modulo da 2 ante

SU RICHIESTA

Finiture	<ul style="list-style-type: none">- Il prodotto può essere realizzato anche in finiture su richiesta, previa conferma fattibilità da parte di De Castelli- Il prezzo è su richiesta
Dimensioni	<ul style="list-style-type: none">- Il prodotto può essere realizzato anche in dimensioni su richiesta, previa conferma fattibilità da parte di De Castelli- In fase di richiesta specificare oltre al numero di ante e mensole, le dimensioni, il materiale e la finitura- Il prezzo è su richiesta

Marea Sideboard 96

DC611

2 doors

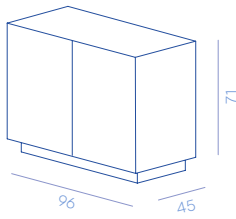

Marea Sideboard 143

DC603

3 doors

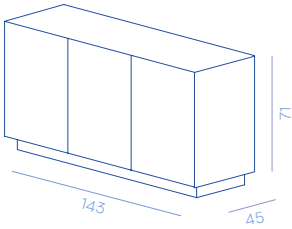

Internal measurements / Misure interne

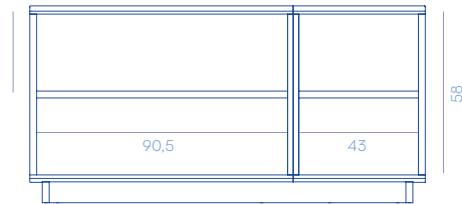

Marea Sideboard 190

DC606

4 doors

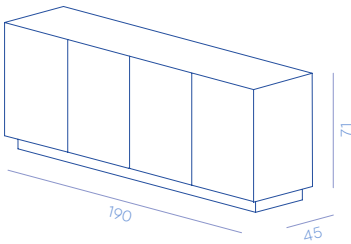

Internal measurements / Misure interne

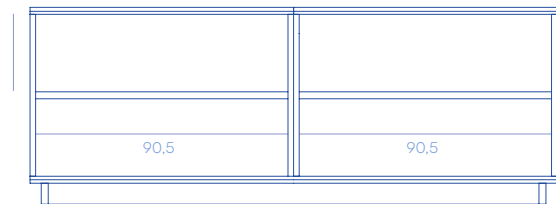

Marea Sideboard 238

DC604

5 doors

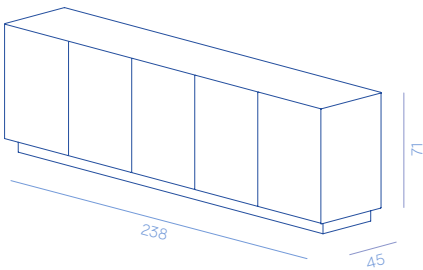

Marea Sideboard 285

DC617

6 doors

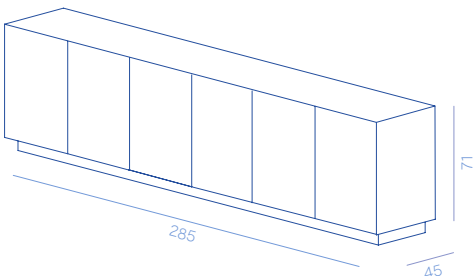

MAREA SIDEBOARD 96 - 2 DOORS

W. 96 D. 45 H. 71 cm

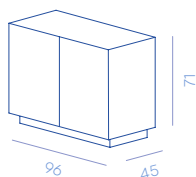

CODE / CODICE	IN	OUT	METAL FINISHES			EURO
DC611-E5			Stainless steel Acciaio inox	DeLabré B DeLabré B	E5	6.240,00
DC611-G2			Stainless steel Acciaio inox	Orbitale DeLabré DeLabré orbitale	G2	6.540,00
DC611-M4			Stainless steel Acciaio inox	DeMarea DeMarea	M4	6.500,00
DC611-F2			Brass Ottone	DeLabré DeLabré	F2	6.600,00
DC611-G3			Brass Ottone	Orbitale DeLabré DeLabré orbitale	G3	6.720,00
DC611-M6			Brass Ottone	DeMarea DeMarea	M6	7.200,00
DC611-G5			Copper Rame	DeLabré DeLabré	G5	6.690,00
DC611-G4			Copper Rame	Orbitale DeLabré DeLabré orbitale	G4	7.180,00
DC611-M5			Copper Rame	DeMarea DeMarea	M5	7.600,00

kg 50 kg

kg 100 kg

cm W. 117 D. 63 H. 107 cm

m³ 0,76 m³

N° 1

Excluding VAT
IVA esclusa

MAREA SIDEBOARD 143 - 3 DOORS

W. 143 D. 45 H. 71 cm

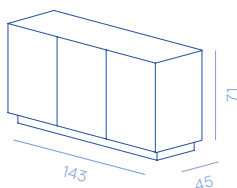

CODE / CODICE	IN	OUT	METAL FINISHES			EURO
DC603-E5	•		Stainless steel Acciaio inox	DeLabré B DeLabré B	E5	8.800,00
DC603-G2	•		Stainless steel Acciaio inox	Orbitale DeLabré DeLabré orbitale	G2	9.100,00
DC603-M4	•		Stainless steel Acciaio inox	DeMarea DeMarea	M4	9.200,00
DC603-F2	•		Brass Ottone	DeLabré DeLabré	F2	9.300,00
DC603-G3	•		Brass Ottone	Orbitale DeLabré DeLabré orbitale	G3	9.400,00
DC603-M6	•		Brass Ottone	DeMarea DeMarea	M6	9.700,00
DC603-G5	•		Copper Rame	DeLabré DeLabré	G5	9.400,00
DC603-G4	•		Copper Rame	Orbitale DeLabré DeLabré orbitale	G4	9.900,00
DC603-M5	•		Copper Rame	DeMarea DeMarea	M5	10.500,00

kg 70 kg

kg 120 kg

cm W. 161 D. 62 H. 107 cm

m³ 1,07 m³

N° 1

Excluding VAT
IVA esclusa

MAREA SIDEBOARD 190 - 4 DOORS

W. 190 D. 45 H. 71 cm

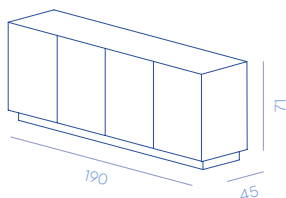

CODE / CODICE	IN	OUT	METAL FINISHES			EURO
DC606-E5	•		Stainless steel Acciaio inox	DeLabré B DeLabré B	E5	10.700,00
DC606-G2	•		Stainless steel Acciaio inox	Orbitale DeLabré DeLabré orbitale	G2	11.000,00
DC606-M4	•		Stainless steel Acciaio inox	DeMarea DeMarea	M4	11.800,00
DC606-F2	•		Brass Ottone	DeLabré DeLabré	F2	10.800,00
DC606-G3	•		Brass Ottone	Orbitale DeLabré DeLabré orbitale	G3	11.000,00
DC606-M6	•		Brass Ottone	DeMarea DeMarea	M6	11.500,00
DC606-G5	•		Copper Rame	DeLabré DeLabré	G5	11.300,00
DC606-G4	•		Copper Rame	Orbitale DeLabré DeLabré orbitale	G4	11.700,00
DC606-M5	•		Copper Rame	DeMarea DeMarea	M5	12.500,00

kg 93 kg

kg 143 kg

cm W. 207 D. 62 H. 107 cm

m³ 1,37 m³

N° 1

Excluding VAT
IVA esclusa

MAREA SIDEBOARD 238 - 5 DOORS

W. 238 D. 45 H. 71 cm

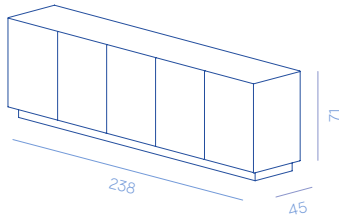

CODE / CODICE	IN	OUT	METAL FINISHES			EURO
DC604-E5	•		Stainless steel Acciaio inox	DeLabré B DeLabré B	E5	14.500,00
DC604-G2	•		Stainless steel Acciaio inox	Orbitale DeLabré DeLabré orbitale	G2	14.800,00
DC604-M4	•		Stainless steel Acciaio inox	DeMarea DeMarea	M4	15.200,00
DC604-F2	•		Brass Ottone	DeLabré DeLabré	F2	14.700,00
DC604-G3	•		Brass Ottone	Orbitale DeLabré DeLabré orbitale	G3	15.200,00
DC604-M6	•		Brass Ottone	DeMarea DeMarea	M6	16.500,00
DC604-G5	•		Copper Rame	DeLabré DeLabré	G5	15.800,00
DC604-G4	•		Copper Rame	Orbitale DeLabré DeLabré orbitale	G4	16.900,00
DC604-M5	•		Copper Rame	DeMarea DeMarea	M5	18.300,00

kg 115 kg

kg 165 kg

cm W. 274 D. 62 H. 107 cm

m³ 1,82 m³

N° 1

Excluding VAT
IVA esclusa

MAREA SIDEBOARD 285 - 6 DOORS

W. 285 D. 45 H. 71 cm

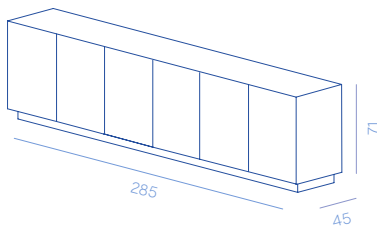

CODE / CODICE	IN	OUT	METAL FINISHES			EURO
DC617-E5	•		Stainless steel Acciaio inox	DeLabré B DeLabré B	E5	15.500,00
DC617-G2	•		Stainless steel Acciaio inox	Orbitale DeLabré DeLabré orbitale	G2	15.900,00
DC617-M4	•		Stainless steel Acciaio inox	DeMarea DeMarea	M4	17.000,00
DC617-F2	•		Brass Ottone	DeLabré DeLabré	F2	16.500,00
DC617-G3	•		Brass Ottone	Orbitale DeLabré DeLabré orbitale	G3	17.000,00
DC617-M6	•		Brass Ottone	DeMarea DeMarea	M6	18.600,00
DC617-G5	•		Copper Rame	DeLabré DeLabré	G5	17.300,00
DC617-G4	•		Copper Rame	Orbitale DeLabré DeLabré orbitale	G4	17.800,00
DC617-M5	•		Copper Rame	DeMarea DeMarea	M5	20.000,00

kg 140 kg

kg 190 kg

cm W. 309 D. 62 H. 107 cm

m³ 2,05 m³

N° 1

Excluding VAT
IVA esclusa

Mida

DESIGN BY ADRIANO DESIGN

Round hanging cabinet clad in metal with left or right sliding opening equipped with two inner fixed shelves.

Pensile tondo rivestito in metallo con apertura scorrevole a destra o sinistra, dotato di due ripiani interni fissi.

Mida Cabinet left
DC601

Right opening
Apertura a dx

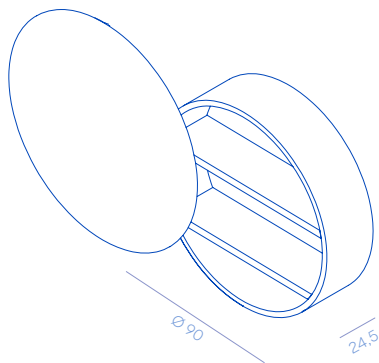

Mida Cabinet right
DC602

Left opening
Apertura a sx

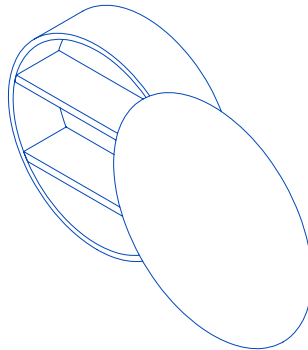

Internal measurements
Misure interne

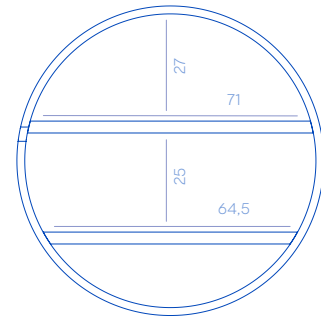

METAL FINISHES

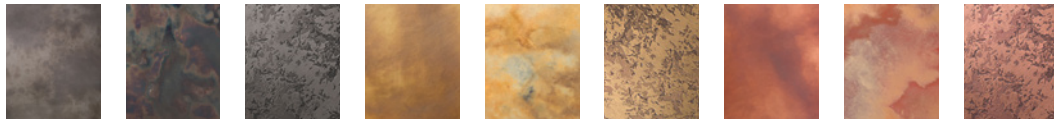

E11

M0

H8

F2

M3

H8

G5

M2

H8

PRODUCT SPECIFICATION

Structure Internal: Matt lacquered RAL 7016 wood
Outer shell: Clad in orbitale DeLabré stainless steel G2



Assembly Shipped assembled

Packaging Wooden crate included **TYPE A**

Details
– Load-bearing wall or reinforced plasterboard is required
– Wall fixing system included, fixing screws excluded
– Left sliding door opening
– Right sliding door opening

DC601
DC602

SPECIFICHE PRODOTTO

Struttura Internal: Matt lacquered RAL 7016 wood
Outer shell: Clad in orbitale DeLabré stainless steel G2



Assemblaggio Spedita montato

Imballo Imballo in cassa incluso **TIPO A**

Dettagli
– È necessaria una parete portante o un cartongesso rinforzato
– Sistema di fissaggio a parete incluso, viti di fissaggio escluse
– Apertura porta scorrevole sinistra
– Apertura porta scorrevole destra

DC601
DC602

ON REQUEST

Finishes The product is available only in the finishes listed

Dimensions The product is available only in the dimensions listed

SU RICHIESTA

Finiture Il prodotto è disponibile solo nelle finiture previste

Dimensioni Il prodotto è disponibile solo nelle dimensioni previste

MIDA CABINET LEFT

Ø 90 D. 24,5 cm

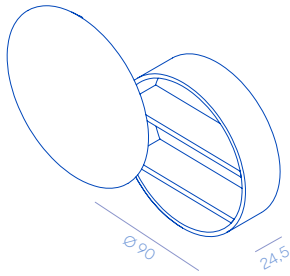

CODE / CODICE	IN	OUT	METAL FINISHES / MATERIALI E FINITURE			EURO
DC601-E11	•		Stainless steel Acciaio inox	DeLabré DeLabré	E11	4.888,00
DC601-M0	•		Stainless steel Acciaio inox	DeOpale DeOpale	M0	4.992,00
DC601-IX-H8	•		Stainless steel Acciaio inox	DeErosion DeErosion	H8	5.200,00
DC601-F2	•		Brass Ottone	DeLabré DeLabré	F2	5.200,00
DC601-M3	•		Brass Ottone	DeOpale DeOpale	M3	4.960,00
DC601-OT-H8	•		Brass Ottone	DeErosion DeErosion	H8	4.830,00
DC601-G5	•		Copper Rame	DeLabré DeLabré	G5	4.740,00
DC601-M2	•		Copper Rame	DeOpale DeOpale	M2	5.145,00
DC601-RA-H8	•		Copper Rame	DeErosion DeErosion	H8	5.150,00

kg 44 kg

kg 56 kg

cm W. 105 D. 105 H. 57 cm

m³ 0,63 m³

N° 1

Excluding VAT
IVA esclusa

MIDA CABINET RIGHT

Ø 90 D. 24,5 cm

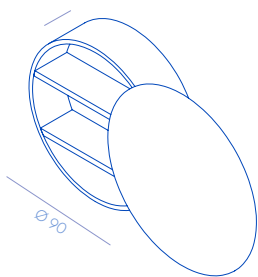

CODE / CODICE	IN	OUT	METAL FINISHES / MATERIALI E FINITURE			EURO
DC602-E11	•		Stainless steel Acciaio inox	DeLabré DeLabré	E11	4.888,00
DC602-M0	•		Stainless steel Acciaio inox	DeOpale DeOpale	M0	4.992,00
DC602-IX-H8	•		Stainless steel Acciaio inox	DeErosion DeErosion	H8	5.200,00
DC602-F2	•		Brass Ottone	DeLabré DeLabré	F2	5.200,00
DC602-M3	•		Brass Ottone	DeOpale DeOpale	M3	4.960,00
DC602-OT-H8	•		Brass Ottone	DeErosion DeErosion	H8	4.830,00
DC602-G5	•		Copper Rame	DeLabré DeLabré	G5	4.740,00
DC602-M2	•		Copper Rame	DeOpale DeOpale	M2	5.145,00
DC602-RA-H8	•		Copper Rame	DeErosion DeErosion	H8	5.150,00

kg 44 kg

kg 56 kg

cm W. 105 D. 105 H. 57 cm

m³ 0,63 m³

N° 1

Excluding VAT
IVA esclusa

Pandora

DESIGN BY MARTINELLI VENEZIA

Circular chest of drawers with invisible push and pull opening drawers, clad in metal on all sides.

Cassettiera circolare con cassetti invisibili con apertura push and pull, rivestita in metallo su tutti i lati.

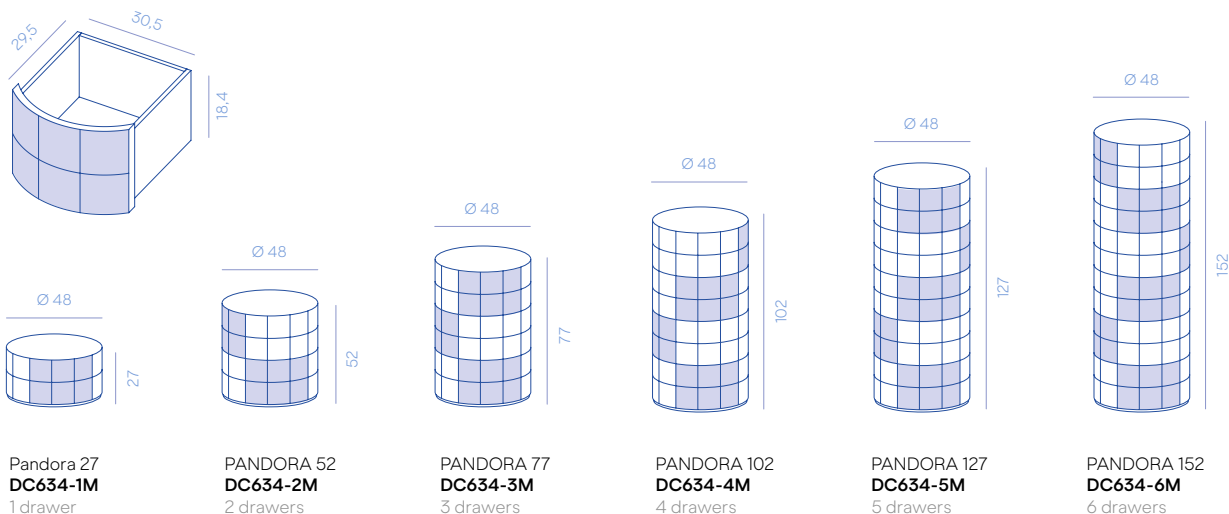

Pandora 27
DC634-1M
1 drawer

PANDORA 52
DC634-2M
2 drawers

PANDORA 77
DC634-3M
3 drawers

PANDORA 102
DC634-4M
4 drawers

PANDORA 127
DC634-5M
5 drawers

PANDORA 152
DC634-6M
6 drawers



The opening of the drawers is misaligned. Please specify at order confirmation an aligned opening, if desired.

L'apertura dei cassetti è disallineata. Specificare al momento dell'ordine se si desidera un'apertura allineata.

METAL FINISHES / MATERIALI E FINITURE

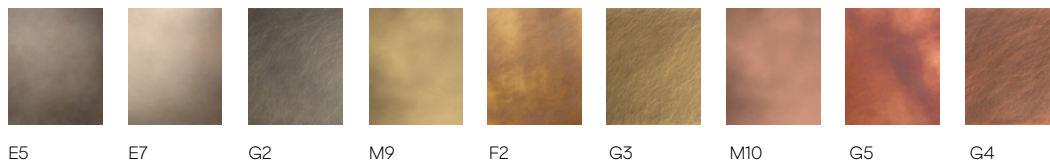

PRODUCT SPECIFICATION

Structure	Natural oak wood 
Assembly	Shipped assembled
Packaging	Wooden crate included TYPE A
Details	<ul style="list-style-type: none"> - Clad in metal on all sides - Hidden drawers as per drawings - Push and pull opening with full-extension Movento slides by Blum - 1 drawer equals 2 metal scales height - The depth of the drawer equals to the entire depth of the chest of drawers

SPECIFICHE PRODOTTO

Struttura	Legno rovere naturale 
Assemblaggio	Spedita montata
Imballo	Imballo in cassa incluso TIPO A
Dettagli	<ul style="list-style-type: none"> - Rivestita in metallo su tutti i lati - Cassetti nascosti come da disegno - Apertura push and pull con guide Movento ad estrazione totale di Blum - 1 cassetto equivale all'altezza di 2 scaglie in metallo - La profondità del cassetto corrisponde a tutta la profondità della cassettiera

ON REQUEST

Finishes	<ul style="list-style-type: none"> - The product can also be made upon request, subject to confirmation of feasibility by De Castelli - Price is on request
Dimensions	The product is available only in the dimensions listed

SU RICHIESTA

Finiture	<ul style="list-style-type: none"> - Il prodotto può essere realizzato anche in finiture su richiesta, previa conferma fattibilità da parte di De Castelli - Il prezzo è su richiesta
Dimensioni	Il prodotto è disponibile solo nelle dimensioni previste

PANDORA 27 - 1 DRAWER

Ø. 48 H. 27 cm

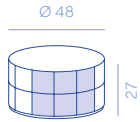

CODE / CODICE	IN	OUT	METAL FINISHES / MATERIALI E FINITURE			EURO
DC634-1M-E5	•		Stainless steel Acciaio inox	DeLabré B DeLabré B	E5	3.200,00
DC634-1M-E7	•		Stainless steel Acciaio inox	DeDarié DeDarié	E7	3.250,00
DC634-1M-G2	•		Stainless steel Acciaio inox	Orbitale DeLabré DeLabré orbitale	G2	3.320,00
DC634-1M-M9	•		Brass Ottone	Brushed Spazzolato	M9	2.860,00
DC634-1M-F2	•		Brass Ottone	DeLabré DeLabré	F2	3.200,00
DC634-1M-G3	•		Brass Ottone	Orbitale DeLabré DeLabré orbitale	G3	3.290,00
DC634-1M-M10	•		Copper Rame	Brushed Spazzolato	M10	2.860,00
DC634-1M-G5	•		Copper Rame	DeLabré DeLabré	G5	3.250,00
DC634-1M-G4	•		Copper Rame	Orbitale DeLabré DeLabré orbitale	G3	3.300,00

kg 23 kg

kg 35 kg

cm W. 80 D. 80 H. 62 cm

m³ 0,40 m³

N° 1

Excluding VAT
IVA esclusa

PANDORA 52 - 2 DRAWERS

Ø. 48 H. 52 cm

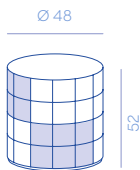

CODE / CODICE	IN	OUT	METAL FINISHES / MATERIALI E FINITURE			EURO
DC634-2M-E5	•		Stainless steel Acciaio inox	DeLabré B DeLabré B	E5	5.500,00
DC634-2M-E7	•		Stainless steel Acciaio inox	DeDarié DeDarié	E7	5.580,00
DC634-2M-G2	•		Stainless steel Acciaio inox	Orbitale DeLabré DeLabré orbitale	G2	5.630,00
DC634-2M-M9	•		Brass Ottone	Brushed Spazzolato	M9	5.700,00
DC634-2M-F2	•		Brass Ottone	DeLabré DeLabré	F2	5.850,00
DC634-2M-G3	•		Brass Ottone	Orbitale DeLabré DeLabré orbitale	G3	5.950,00
DC634-2M-M10	•		Copper Rame	Brushed Spazzolato	M10	5.850,00
DC634-2M-G5	•		Copper Rame	DeLabré DeLabré	G5	6.400,00
DC634-2M-G4	•		Copper Rame	Orbitale DeLabré DeLabré orbitale	G3	6.600,00

kg 42 kg

kg 60 kg

cm W. 80 D. 80 H. 62 cm

m³ 0,56 m³

N° 1

Excluding VAT
IVA esclusa

PANDORA 77 - 3 DRAWERS

Ø. 48 H. 77 cm

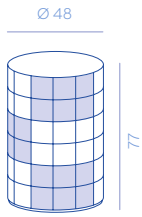

CODE / CODICE	IN	OUT	METAL FINISHES / MATERIALI E FINITURE			EURO
DC634-3M-E5	•		Stainless steel Acciaio inox	DeLabré B DeLabré B	E5	8.000,00
DC634-3M-E7	•		Stainless steel Acciaio inox	DeDarié DeDarié	E7	8.100,00
DC634-3M-G2	•		Stainless steel Acciaio inox	Orbitale DeLabré DeLabré orbitale	G2	8.200,00
DC634-3M-M9	•		Brass Ottone	Brushed Spazzolato	M9	8.300,00
DC634-3M-F2	•		Brass Ottone	DeLabré DeLabré	F2	8.700,00
DC634-3M-G3	•		Brass Ottone	Orbitale DeLabré DeLabré orbitale	G3	8.800,00
DC634-3M-M10	•		Copper Rame	Brushed Spazzolato	M10	8.450,00
DC634-3M-G5	•		Copper Rame	DeLabré DeLabré	G5	8.900,00
DC634-3M-G4	•		Copper Rame	Orbitale DeLabré DeLabré orbitale	G3	9.300,00

kg 60 kg

kg 80 kg

cm W. 80 D. 80 H. 112 cm

m³ 0,72 m³

N° 1

Excluding VAT
IVA esclusa

PANDORA 102 - 4 DRAWERS

Ø. 48 H. 102 cm

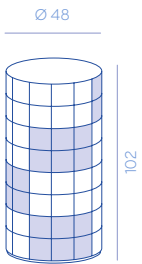

CODE / CODICE	IN	OUT	METAL FINISHES / MATERIALI E FINITURE			EURO
DC634-4M-E5	•		Stainless steel Acciaio inox	DeLabré B DeLabré B	E5	10.300,00
DC634-4M-E7	•		Stainless steel Acciaio inox	DeDarié DeDarié	E7	10.400,00
DC634-4M-G2	•		Stainless steel Acciaio inox	Orbitale DeLabré DeLabré orbitale	G2	10.500,00
DC634-4M-M9	•		Brass Ottone	Brushed Spazzolato	M9	11.000,00
DC634-4M-F2	•		Brass Ottone	DeLabré DeLabré	F2	11.500,00
DC634-4M-G3	•		Brass Ottone	Orbitale DeLabré DeLabré orbitale	G3	11.800,00
DC634-4M-M10	•		Copper Rame	Brushed Spazzolato	M10	11.300,00
DC634-4M-G5	•		Copper Rame	DeLabré DeLabré	G5	12.000,00
DC634-4M-G4	•		Copper Rame	Orbitale DeLabré DeLabré orbitale	G3	12.600,00

kg 77 kg

kg 98 kg

cm W. 80 D. 80 H. 137 cm

m³ 0,88 m³

N° 1

Excluding VAT
IVA esclusa

PANDORA 127 - 5 DRAWERS

Ø. 48 H. 127 cm

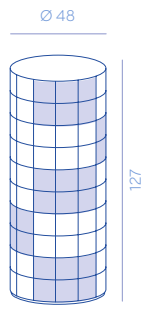

CODE / CODICE	IN	OUT	METAL FINISHES / MATERIALI E FINITURE			EURO
DC634-5M-E5	•		Stainless steel Acciaio inox	DeLabré B DeLabré B	E5	12.000,00
DC634-5M-E7	•		Stainless steel Acciaio inox	DeDarié DeDarié	E7	12.100,00
DC634-5M-G2	•		Stainless steel Acciaio inox	Orbitale DeLabré DeLabré orbitale	G2	12.300,00
DC634-5M-M9	•		Brass Ottone	Brushed Spazzolato	M9	12.900,00
DC634-5M-F2	•		Brass Ottone	DeLabré DeLabré	F2	13.400,00
DC634-5M-G3	•		Brass Ottone	Orbitale DeLabré DeLabré orbitale	G3	13.700,00
DC634-5M-M10	•		Copper Rame	Brushed Spazzolato	M10	13.200,00
DC634-5M-G5	•		Copper Rame	DeLabré DeLabré	G5	14.000,00
DC634-5M-G4	•		Copper Rame	Orbitale DeLabré DeLabré orbitale	G3	14.600,00

kg 96 kg

kg 120 kg

cm W. 80 D. 80 H. 162 cm

m³ 1,04 m³

N° 1

Excluding VAT
IVA esclusa

PANDORA 152 - 6 DRAWERS

Ø. 48 H. 152 cm

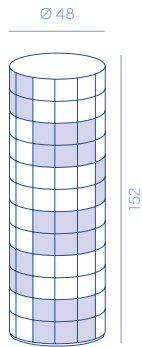

CODE / CODICE	IN	OUT	METAL FINISHES / MATERIALI E FINITURE			EURO
DC634-6M-E5	•		Stainless steel Acciaio inox	DeLabré B DeLabré B	E5	14.600,00
DC634-6M-E7	•		Stainless steel Acciaio inox	DeDarié DeDarié	E7	14.700,00
DC634-6M-G2	•		Stainless steel Acciaio inox	Orbitale DeLabré DeLabré orbitale	G2	15.000,00
DC634-6M-M9	•		Brass Ottone	Brushed Spazzolato	M9	15.600,00
DC634-6M-F2	•		Brass Ottone	DeLabré DeLabré	F2	16.300,00
DC634-6M-G3	•		Brass Ottone	Orbitale DeLabré DeLabré orbitale	G3	16.600,00
DC634-6M-M10	•		Copper Rame	Brushed Spazzolato	M10	16.200,00
DC634-6M-G5	•		Copper Rame	DeLabré DeLabré	G5	17.000,00
DC634-6M-G4	•		Copper Rame	Orbitale DeLabré DeLabré orbitale	G3	17.600,00

kg 115 kg

kg 145 kg

cm W. 80 D. 80 H. 187 cm

m³ 1,20 m³

N° 1

Excluding VAT
IVA esclusa

Polifemo

DESIGN BY ELENA SALMISTRARO

Sculptural cabinet with two doors clad in metal on all sides, back excluded. Safety wall fixing system is highly recommended.

Cabinet scultorea a due ante rivestito in metallo su tutti i lati, schienale escluso. Si consiglia vivamente il sistema di fissaggio a parete di sicurezza.

Polifemo
DC550

Open / Aperto

Internal measurements / Misure interne

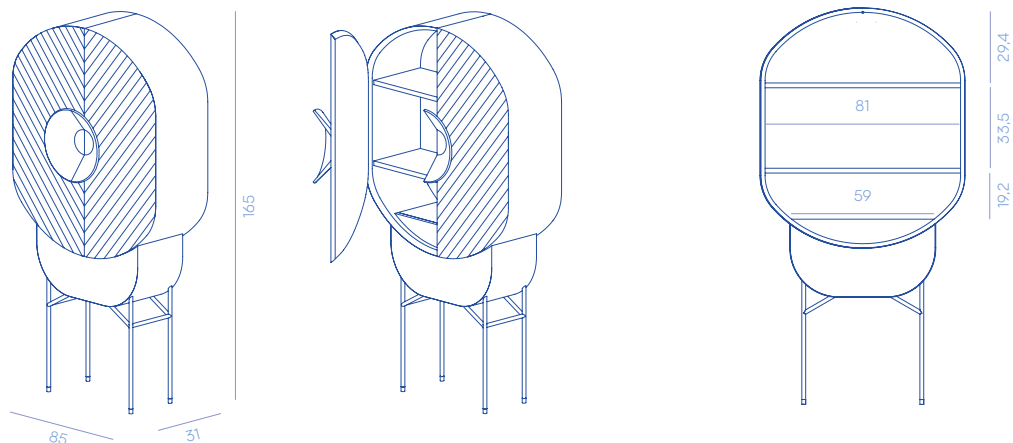

METAL FINISHES



M9



M10

PRODUCT SPECIFICATION

Struttura

Internal: matt lacquered RAL 7016 wood
Legs: DeLabré B stainless steel E5



Assemblaggio

Shipped assembled

Imballo

Wooden crate included [TYPE A](#)

Dettagli

- Clad in metal on all sides, back excluded
- Two fixed shelves
- Safety wall fixing is highly recommended
- Load-bearing wall or reinforced plasterboard is required
- Wall fixing system included, fixing screws excluded

SPECIFICHE PRODOTTO

Struttura

Interna: legno laccato RAL 7016 opaco
Gambe: Acciaio inox DeLabré B E5



Assemblaggio

Spedita montato

Imballo

Imballo in cassa incluso [TIPO A](#)

Dettagli

- Rivestito in metallo su tutti i lati, escluso il retro
- Due ripiani fissi
- Si consiglia vivamente il fissaggio a parete di sicurezza
- È necessaria una parete portante o un cartongesso rinforzato
- Sistema di fissaggio a parete incluso, viti di fissaggio escluse

ON REQUEST

Finishes

The product is available only in the finishes listed

Dimensions

The product is available only in the dimensions listed

SU RICHIESTA

Finiture

Il prodotto è disponibile solo nelle finiture previste

Dimensioni

Il prodotto è disponibile solo nelle dimensioni previste

POLIFEMO

W. 85 D. 31 H. 165 cm

CODE / CODICE	IN	OUT	METAL FINISHES			EURO
DC550-M9	•		Brass Ottone	Brushed Spazzolato	M9	20.000,00
DC550-M10	•		Copper Rame	Brushed Spazzolato	M10	22.000,00

 55 kg

 85 kg

 W. 184 D. 109 H. 72 cm

 1,44 m³

 1

Excluding VAT
IVA esclusa

Ripple

DESIGN BY MARCO PISATI

Sculptural cabinet characterized by an organic shape with 2 push and pull 180° doors opening, clad in metal on all sides. Equipped with 3 shelves per each compartment.

Cabinet scultoreo caratterizzato da una forma organica con 2 ante con apertura push and pull a 180°, rivestito in metallo su tutti i lati. Dotato di 3 ripiani per ogni vano.

Ripple
DC696

Open / Aperto

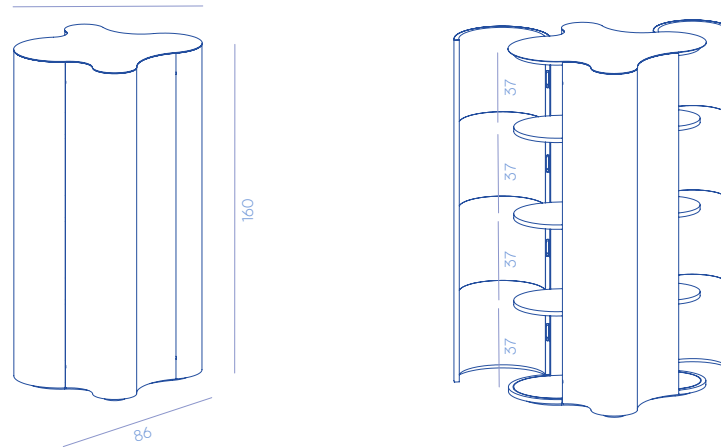

METAL FINISHES

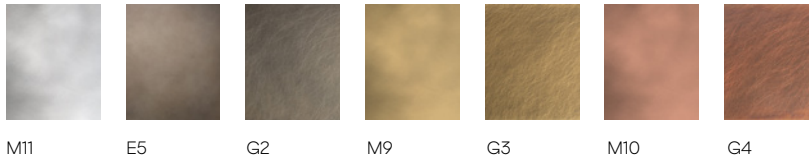

PRODUCT SPECIFICATION

Struttura	Matt lacquered RAL 7016 wood
Assemblaggio	Shipped assembled
Imballo	Wooden crate included TYPE A
Dettagli	<ul style="list-style-type: none"> - Clad in metal on all sides - Two hidden doors with 180° push and pull opening - Equipped with 3 fixed shelves per compartment

SPECIFICHE PRODOTTO

Struttura	Legno laccato RAL 7016 opaco
Assemblaggio	Spedito montato
Imballo	Imballo in cassa incluso TIPO A
Dettagli	<ul style="list-style-type: none"> - Rivestito in metallo su tutti i lati - Due ante nascoste con apertura push and pull a 180° - Dotato di 3 ripiani fissi per vano

ON REQUEST

Finishes	<ul style="list-style-type: none"> - The product can also be made upon request, subject to confirmation of feasibility by De Castelli - Price is on request
Dimensions	The product is available only in the dimensions listed

SU RICHIESTA

Finiture	<ul style="list-style-type: none"> - Il prodotto può essere realizzato anche in finiture su richiesta, previa conferma fattibilità da parte di De Castelli - Il prezzo è su richiesta
Dimensioni	Il prodotto è disponibile solo nelle dimensioni previste

RIPPLE

W. 88 D. 86 H. 160 cm

CODE / CODICE	IN	OUT	METAL FINISHES			EURO
DC696-M11	•		Stainless steel Acciaio inox	Brushed Spazzolato	M11	11.000,00
DC696-E5	•		Stainless steel Acciaio inox	DeLabré B DeLabré B	E5	11.800,00
DC696-G2	•		Stainless steel Acciaio inox	Orbitale DeLabré DeLabré orbitale	G2	12.200,00
DC696-M9	•		Brass Ottone	Brushed Spazzolato	M9	13.000,00
DC696-G3	•		Brass Ottone	Orbitale DeLabré DeLabré orbitale	G3	14.400,00
DC696-M10	•		Copper Rame	Brushed Spazzolato	M10	14.900,00
DC696-G4	•		Copper Rame	Orbitale DeLabré DeLabré orbitale	G4	15.300,00

 160 kg

 190 kg

 W. 106 D. 108 H. 192 cm

 2,20 m³

 1

Excluding VAT
IVA esclusa

Sculpt

DESIGN BY FRANCESCO FORCELLINI

Sideboard clad in metal on all sides characterised by domed sides and domed doors entirely made of metal with a 45° angle and push and pull opening system.

Madia rivestita in metallo su tutti i lati caratterizzata da fianchi bombati e ante bombate interamente in metallo con angolo a 45° e sistema di apertura push and pull.

METAL FINISHES

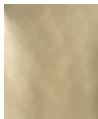

M16

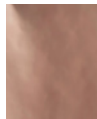

M17

PRODUCT SPECIFICATION

Struttura	Matt lacquered RAL 7024 wood
	
Assemblaggio	Shipped assembled
Imballo	Wooden crate included TYPE A
Dettagli	<ul style="list-style-type: none">- Clad in metal on all sides- Domed sides and domed doors entirely made of metal with 45° folding and push and pull opening- Flat metal cladding for the back and top- Equipped with one central fixed shelf per each module of 2 doors

ON REQUEST

Finishes	The product is available only in the finishes listed
Dimensions	The product is available only in the dimensions listed

SPECIFICHE PRODOTTO

Struttura	Legno laccato RAL 7024 opaco
	
Assemblaggio	Spedita montato
Imballo	Imballo in cassa incluso TIPO A
Dettagli	<ul style="list-style-type: none">- Rivestita in metallo su tutti i lati- Fianchi bombati e ante bombate interamente in metallo con angolo a 45° e apertura push and pull- Rivestimento in metallo piano per la schiena e il top- Dotata di un ripiano centrale fisso per ogni modulo da 2 ante

SU RICHIESTA

Finiture	Il prodotto è disponibile solo nelle finiture previste
Dimensioni	Il prodotto è disponibile solo nelle dimensioni previste

Sculpt 83
DC725
2 doors

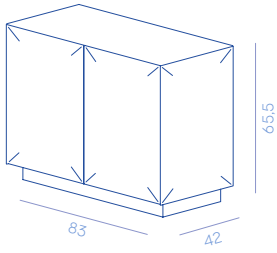

Sculpt 124
DC691
3 doors

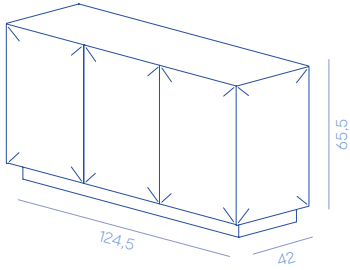

Internal measurements / Misure interne

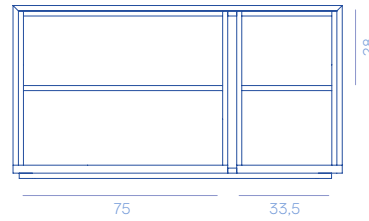

Sculpt 165
DC690
4 doors

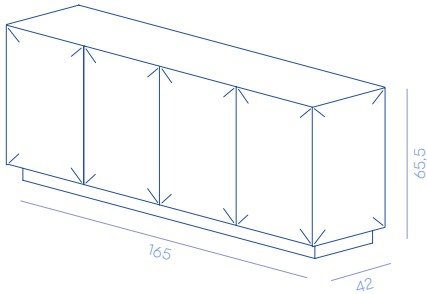

Internal measurements / Misure interne

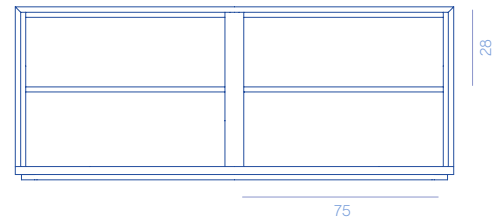

Sculpt 207
DC692
5 doors

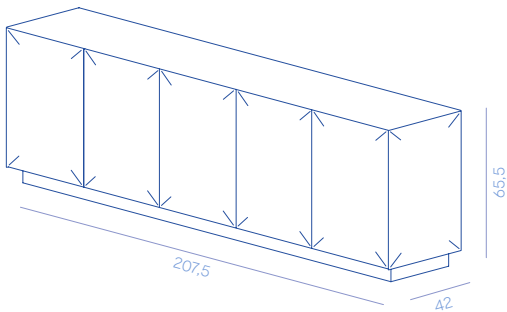

Sculpt 249
DC726
6 doors

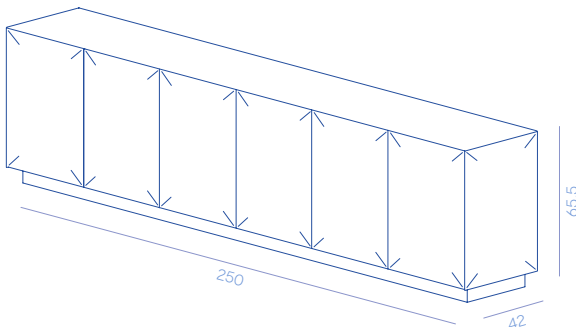

SCULPT 83

W. 83 D. 42 H. 65,5 cm

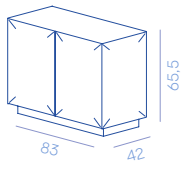

CODE / CODICE	IN	OUT	METAL FINISHES			EURO
DC725-M16	•		Brass Ottone	DeSatén DeSatén	M16	8.000,00
DC725-M17	•		Copper Rame	DeSatén DeSatén	M17	8.800,00

kg 50 kg
 kg 80 kg
 cm W. 103 D. 62 H. 98 cm
 m³ 0,63 m³
 Nº 1
 Excluding VAT IVA esclusa

SCULPT 124

W. 124,5 D. 42 H. 65,5 cm

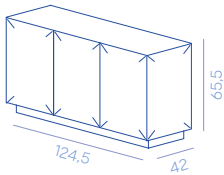

CODE / CODICE	IN	OUT	METAL FINISHES			EURO
DC691-M16	•		Brass Ottone	DeSatén DeSatén	M16	11.300,00
DC691-M17	•		Copper Rame	DeSatén DeSatén	M17	12.300,00

kg 75 kg
 kg 105 kg
 cm W. 145 D. 62 H. 98 cm
 m³ 0,88 m³
 Nº 1
 Excluding VAT IVA esclusa

SCULPT 165

W. 165 D. 42 H. 65,5 cm

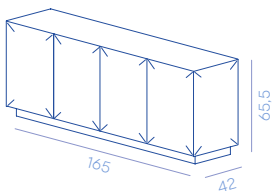

CODE / CODICE	IN	OUT	METAL FINISHES			EURO
DC690-M16	•		Brass Ottone	DeSatén DeSatén	M16	14.200,00
DC690-M17	•		Copper Rame	DeSatén DeSatén	M17	15.300,00

kg 100 kg
 kg 130 kg
 cm W. 184 D. 62 H. 97 cm
 m³ 1,12 m³
 Nº 1
 Excluding VAT IVA esclusa

SCULPT 207

W. 207,5 D. 42 H. 65,5 cm

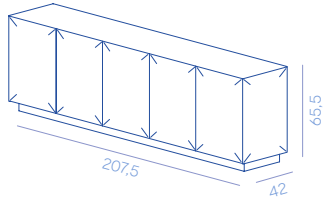

CODE / CODICE	IN	OUT	METAL FINISHES			EURO
DC692-M16	•		Brass Ottone	DeSatén DeSatén	M16	17.500,00
DC692-M17	•		Copper Rame	DeSatén DeSatén	M17	18.500,00

kg 125 kg
 kg 155 kg
 cm W. 227 D. 62 H. 88 cm
 m³ 1,20 m³
 Nº 1
 Excluding VAT
IVA esclusa

SCULPT 250

W. 250 D. 42 H. 65,5 cm

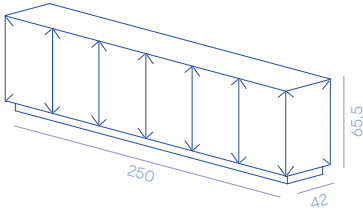

CODE / CODICE	IN	OUT	METAL FINISHES			EURO
DC726-M16	•		Brass Ottone	DeSatén DeSatén	M16	19.800,00
DC726-M17	•		Copper Rame	DeSatén DeSatén	M17	21.200,00

kg 150 kg
 kg 180 kg
 cm W. 269 D. 62 H. 98 cm
 m³ 1,63 m³
 Nº 1
 Excluding VAT
IVA esclusa

Tako floor Console

DESIGN BY FILIPPO PISAN

Free-standing console clad in metal on all sides, back excluded, with 1 or 2 pull-out opening drawers.

Console da terra rivestita in metallo su tutti i lati, schienale escluso, con 1 o 2 cassetti con apertura estraibile.

Tako Floor console 110
DC638T

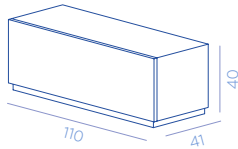

Tako Floor console 220
DC637T

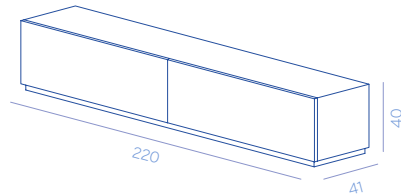

METAL FINISHES

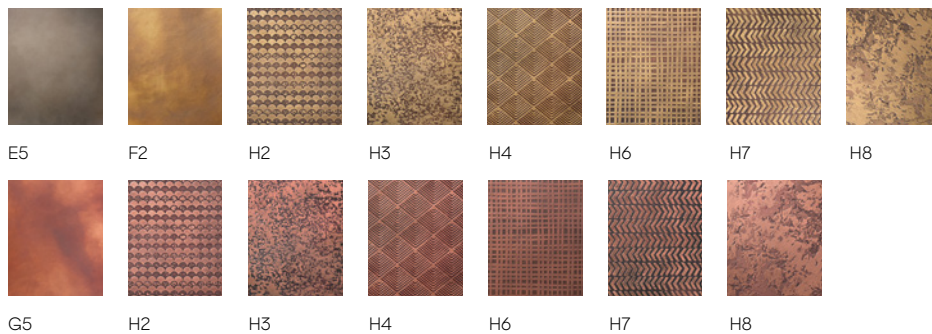

PRODUCT SPECIFICATION

Struttura	Natural oak wood 
Assemblaggio	Shipped assembled
Imballo	Wooden crate included TYPE A
Dettagli	<ul style="list-style-type: none"> - Clad in metal on all sides, back excluded - Top and sides always clad in DeLabré B stainless steel E5 - Pull-out drawer opening with full-extension Blumotion Movento slides by Blum

SPECIFICHE PRODOTTO

Struttura	Legno rovere naturale 
Assemblaggio	Spedita montata
Imballo	Imballo in cassa incluso TIPO A
Dettagli	<ul style="list-style-type: none"> - Rivestita in metallo su tutti i lati, schienale escluso - Top e fianchi sempre rivestiti in acciaio inox DeLabré B E5 - Apertura cassetto a tirare con guide Blumotion Movento ad estrazione totale di Blum

ON REQUEST

Finishes	<ul style="list-style-type: none"> - The product can also be made upon request, subject to confirmation of feasibility by De Castelli - Top and side always clad in DeLabré stainless steel E5 - Price is on request
Dimensions	<ul style="list-style-type: none"> - The product can also be made in dimensions on request, subject to confirmation of feasibility by De Castelli - The maximum length of the front of the drawer is 140 cm - For custom made products please specify the number of drawers as well as the dimensions, material and finishing - Price is on request

SU RICHIESTA

Finiture	<ul style="list-style-type: none"> - Il prodotto può essere realizzato anche in finiture su richiesta, previa conferma fattibilità da parte di De Castelli - Top e laterali sempre rivestiti in acciaio inox DeLabré E5 - Il prezzo è su richiesta
Dimensioni	<ul style="list-style-type: none"> - Il prodotto può essere realizzato anche in dimensioni su richiesta, previa conferma fattibilità da parte di De Castelli - La lunghezza massima del frontale del cassetto è di 140 cm - In fase di richiesta specificare oltre al numero di cassetti, le dimensioni, il materiale e la finitura - Il prezzo è su richiesta

TAKO 110 FLOOR CONSOLE

W. 110 D. 41 H. 40 cm

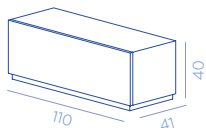

CODE / CODICE	IN	OUT	METAL FINISHES / MATERIALI E FINITURE			EURO
DC638T-IX-E5	•		Stainless steel Acciaio inox	DeLabré B DeLabré B	E5	5.500,00
DC638T-OT-F2	•		Brass Ottone	DeLabré DeLabré	F2	5.780,00
DC638T-RA-G5	•		Copper Rame	DeLabré DeLabré	G5	5.980,00
DC638T-OT-H2	•		Brass Ottone	DeErosion DeErosion	H2	6.100,00
DC638T-OT-H3	•		Brass Ottone	DeErosion DeErosion	H3	6.100,00
DC638T-OT-H4	•		Brass Ottone	DeErosion DeErosion	H4	6.100,00
DC638T-OT-H6	•		Brass Ottone	DeErosion DeErosion	H6	6.100,00
DC638T-OT-H7	•		Brass Ottone	DeErosion DeErosion	H7	6.100,00
DC638T-OT-H8	•		Brass Ottone	DeErosion DeErosion	H8	6.100,00
DC638T-RA-H2	•		Copper Rame	DeErosion DeErosion	H2	6.550,00
DC638T-RA-H3	•		Copper Rame	DeErosion DeErosion	H3	6.550,00
DC638T-RA-H4	•		Copper Rame	DeErosion DeErosion	H4	6.550,00
DC638T-RA-H6	•		Copper Rame	DeErosion DeErosion	H6	6.550,00
DC638T-RA-H7	•		Copper Rame	DeErosion DeErosion	H7	6.550,00
DC638T-RA-H8	•		Copper Rame	DeErosion DeErosion	H8	6.550,00

kg 45 kg

kg 58 kg

cm W. 129 D. 59 H. 67 cm

m³ 0,50 m³

N° 1

Excluding VAT
IVA esclusa

TAKO 220 FLOOR CONSOLE

W. 220 D. 41 H. 40 cm

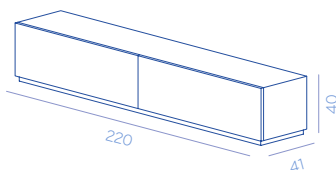

CODE / CODICE	IN	OUT	METAL FINISHES / MATERIALI E FINITURE			EURO
DC637T-IX-E5	•		Stainless steel Acciaio inox	DeLabré B DeLabré B	E5	8.700,00
DC637T-OT-F2	•		Brass Ottone	DeLabré DeLabré	F2	9.140,00
DC637T-RA-G5	•		Copper Rame	DeLabré DeLabré	G5	9.300,00
DC637T-OT-H2	•		Brass Ottone	DeErosion DeErosion	H2	9.400,00
DC637T-OT-H3	•		Brass Ottone	DeErosion DeErosion	H3	9.400,00
DC637T-OT-H4	•		Brass Ottone	DeErosion DeErosion	H4	9.400,00
DC637T-OT-H6	•		Brass Ottone	DeErosion DeErosion	H6	9.400,00
DC637T-OT-H7	•		Brass Ottone	DeErosion DeErosion	H7	9.400,00
DC637T-OT-H8	•		Brass Ottone	DeErosion DeErosion	H8	9.400,00
DC637T-RA-H2	•		Copper Rame	DeErosion DeErosion	H2	9.830,00
DC637T-RA-H3	•		Copper Rame	DeErosion DeErosion	H3	9.830,00
DC637T-RA-H4	•		Copper Rame	DeErosion DeErosion	H4	9.830,00
DC637T-RA-H6	•		Copper Rame	DeErosion DeErosion	H6	9.830,00
DC637T-RA-H7	•		Copper Rame	DeErosion DeErosion	H7	9.830,00
DC637T-RA-H8	•		Copper Rame	DeErosion DeErosion	H8	9.830,00

kg 95 kg

kg 115 kg

cm W. 239 D. 59 H. 67 cm

m³ 0,95 m³

N° 1

Excluding VAT
IVA esclusa

Tako wall-mounted Console

DESIGN BY FILIPPO PISAN

Wall-mounted console clad in metal on all sides, back excluded, with 1 or 2 pull-out opening drawers. Console da parete rivestita in metallo su tutti i lati, schienale escluso, con 1 o 2 cassetti con apertura estraibile.

Tako wall mounted Console 110
DC638

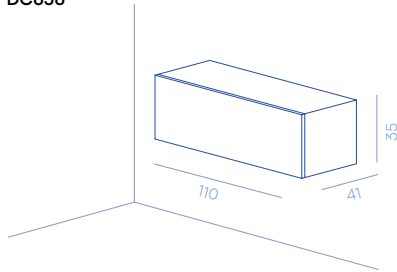

Tako wall mounted Console 220
DC637

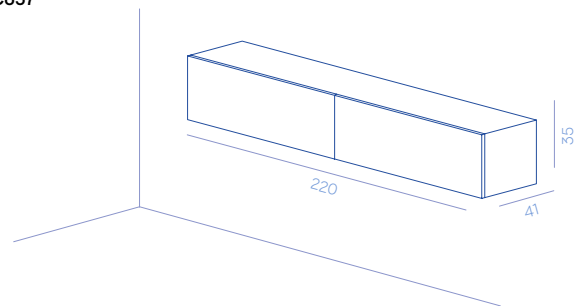

METAL FINISHES

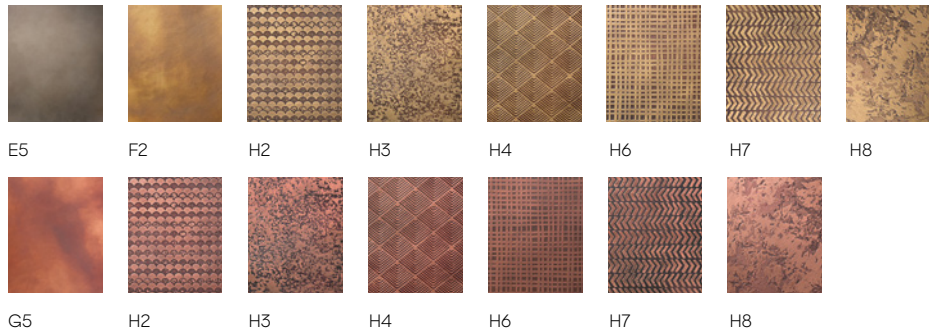

PRODUCT SPECIFICATION

Struttura	Natural oak wood 
Assemblaggio	Shipped assembled
Imballo	Wooden crate included TYPE A
Dettagli	<ul style="list-style-type: none"> - Clad in metal on all sides, back excluded - Top, bottom and sides always clad in DeLabré B stainless steel E5 - Pull drawer opening with full-extention Blumotion Movento slides by Blum - Load-bearing wall or reinforced plasterboard is required - Wall fixing system included, fixing screws excluded

ON REQUEST

Finishes	<ul style="list-style-type: none"> - The product can also be made upon request, subject to confirmation of feasibility by De Castelli - Top, sides and bottom always clad in DeLabré stainless steel E5 - Price is on request
Dimensions	<ul style="list-style-type: none"> - The product can also be made in dimensions on request, subject to confirmation of feasibility by De Castelli - The maximum length of the front of the drawer is 140 cm - For custom made products please specify the number of drawers as well as the dimensions, material and finishing - Price is on request

SPECIFICHE PRODOTTO

Struttura	Legno rovere naturale 
Assemblaggio	Spedita montata
Imballo	Imballo in cassa incluso TIPO A
Dettagli	<ul style="list-style-type: none"> - Rivestita in metallo su tutti i lati, schienale escluso - Top, fondo e fianchi sempre rivestiti in acciaio inox DeLabré B - Apertura cassetto a tirare con guide Blumotion Movento ad estrazione totale di Blum - È necessaria una parete portante o un cartongesso rinforzato - Sistema di fissaggio a parete incluso, viti di fissaggio escluse

SU RICHIESTA

Finiture	<ul style="list-style-type: none"> - Il prodotto può essere realizzato anche in finiture su richiesta, previa conferma fattibilità da parte di De Castelli - Top, laterali e fondo sempre rivestiti in acciaio inox DeLabré E5 - Il prezzo è su richiesta
Dimensioni	<ul style="list-style-type: none"> - Il prodotto può essere realizzato anche in dimensioni su richiesta, previa conferma fattibilità da parte di De Castelli - La lunghezza massima del frontale del cassetto è di 140 cm - In fase di richiesta specificare oltre al numero di cassetti, le dimensioni, il materiale e la finitura - Il prezzo è su richiesta

TAKO 110 WALL-MOUNTED CONSOLE

W. 110 D. 41 H. 35 cm

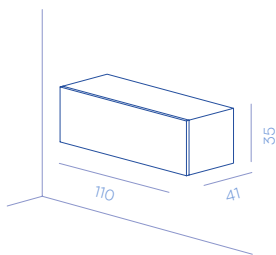

CODE / CODICE	IN	OUT	METAL FINISHES / MATERIALI E FINITURE			EURO
DC638-IX-E5	•		Stainless steel Acciaio inox	DeLabré B DeLabré B	E5	5.200,00
DC638-OT-F2	•		Brass Ottone	DeLabré DeLabré	F2	5.480,00
DC638-RA-G5	•		Copper Rame	DeLabré DeLabré	G5	5.680,00
DC638-OT-H2	•		Brass Ottone	DeErosion DeErosion	H2	5.800,00
DC638-OT-H3	•		Brass Ottone	DeErosion DeErosion	H3	5.800,00
DC638-OT-H4	•		Brass Ottone	DeErosion DeErosion	H4	5.800,00
DC638-OT-H6	•		Brass Ottone	DeErosion DeErosion	H6	5.800,00
DC638-OT-H7	•		Brass Ottone	DeErosion DeErosion	H7	5.800,00
DC638-OT-H8	•		Brass Ottone	DeErosion DeErosion	H8	5.800,00
DC638-RA-H2	•		Copper Rame	DeErosion DeErosion	H2	6.250,00
DC638-RA-H3	•		Copper Rame	DeErosion DeErosion	H3	6.250,00
DC638-RA-H4	•		Copper Rame	DeErosion DeErosion	H4	6.250,00
DC638-RA-H6	•		Copper Rame	DeErosion DeErosion	H6	6.250,00
DC638-RA-H7	•		Copper Rame	DeErosion DeErosion	H7	6.250,00
DC638-RA-H8	•		Copper Rame	DeErosion DeErosion	H8	6.250,00

kg 45 kg

kg 58 kg

cm W. 129 D. 59 H. 67 cm

m³ 0,50 m³

N° 1

Excluding VAT
IVA esclusa

TAKO 110 WALL-MOUNTED CONSOLE

W. 220 D. 41 H. 35 cm

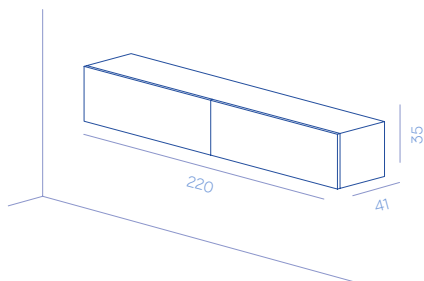

CODE / CODICE	IN	OUT	METAL FINISHES / MATERIALI E FINITURE			EURO
DC637-IX-E5	•		Stainless steel Acciaio inox	DeLabré B DeLabré B	E5	8.350,00
DC637-OT-F2	•		Brass Ottone	DeLabré DeLabré	F2	8.800,00
DC637-RA-G5	•		Copper Rame	DeLabré DeLabré	G5	9.130,00
DC637-OT-H2	•		Brass Ottone	DeErosion DeErosion	H2	9.300,00
DC637-OT-H3	•		Brass Ottone	DeErosion DeErosion	H3	9.300,00
DC637-OT-H4	•		Brass Ottone	DeErosion DeErosion	H4	9.300,00
DC637-OT-H6	•		Brass Ottone	DeErosion DeErosion	H6	9.300,00
DC637-OT-H7	•		Brass Ottone	DeErosion DeErosion	H7	9.300,00
DC637-OT-H8	•		Brass Ottone	DeErosion DeErosion	H8	9.300,00
DC637-RA-H2	•		Copper Rame	DeErosion DeErosion	H2	9.400,00
DC637-RA-H3	•		Copper Rame	DeErosion DeErosion	H3	9.400,00
DC637-RA-H4	•		Copper Rame	DeErosion DeErosion	H4	9.400,00
DC637-RA-H6	•		Copper Rame	DeErosion DeErosion	H6	9.400,00
DC637-RA-H7	•		Copper Rame	DeErosion DeErosion	H7	9.400,00
DC637-RA-H8	•		Copper Rame	DeErosion DeErosion	H8	9.400,00

kg 95 kg

kg 115 kg

cm W. 239 D. 59 H. 67 cm

m³ 0,95 m³

N° 1

Excluding VAT
IVA esclusa

Xilo Console

DESIGN BY DELINEO DESIGN STUDIO

Wall-mounted console clad in metal on all sides, back excluded, with doors opening. Equipped with inner pull-out opening drawers, 1 per each door.

Consolle sospesa rivestita in metallo su tutti i lati, schienale escluso, con apertura ad ante. Dotato di cassetti interni con apertura estraibile, 1 per ogni anta.

METAL FINISHES

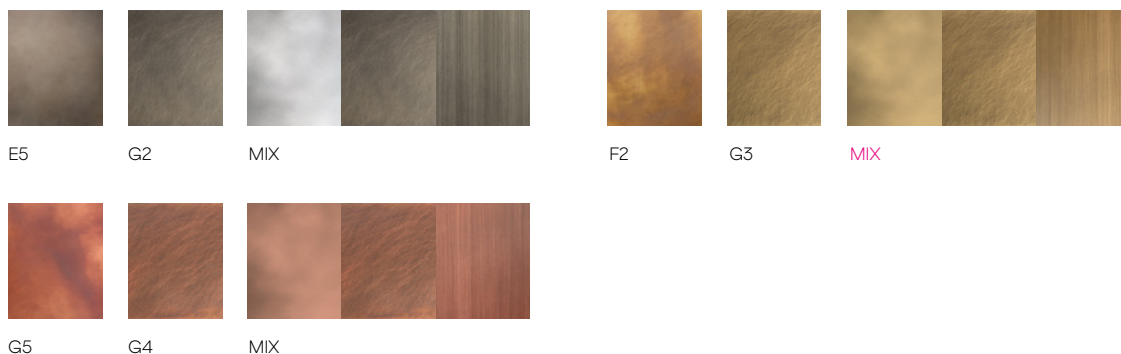

PRODUCT SPECIFICATION

Structure	Matt lacquered RAL 7024 wood
Assembly	Shipped disassembled
Packaging	Wooden crate included TYPE A
Details	<ul style="list-style-type: none">- Clad in metal on all sides, back excluded- Pull-out door opening- Equipped with inner drawer with pull opening- Load-bearing wall or reinforced plasterboard is required- Wall fixing system included, fixing screws excluded

SPECIFICHE PRODOTTO

Struttura	Legno laccato RAL 7024 opaco
Assemblaggio	Spedita montata
Imballo	Imballo in cassa incluso TIPO A
Dettagli	<ul style="list-style-type: none">- Rivestita in metallo su tutti i lati, schienale escluso- Apertura anta a tirare- Dotata di cassetti interni con apertura estraibile- È necessaria una parete portante o un cartongesso rinforzato- Sistema di fissaggio a parete incluso, viti di fissaggio escluse

ON REQUEST

Finishes	The product is available only in the finishes listed
Dimensions	The product is available only in the dimensions listed

SU RICHIESTA

Finiture	Il prodotto è disponibile solo nelle finiture previste
Dimensioni	Il prodotto è disponibile solo nelle dimensioni previste

Xilo Console 100
DC705

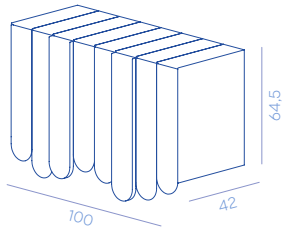

Xilo Console 150
DC706

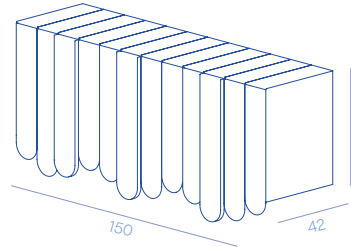

Internal measurements / Misure interne

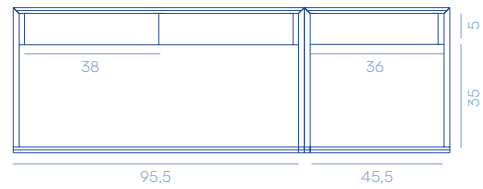

Xilo Console 200
DC707

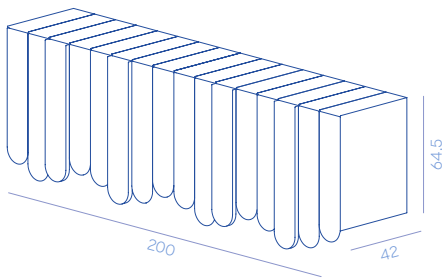

Internal measurements / Misure interne

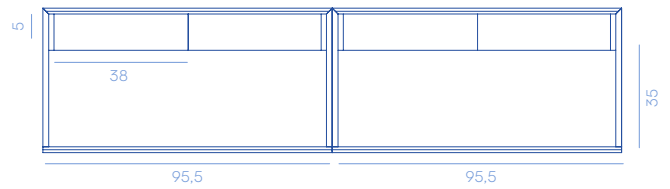

Xilo Console 250
DC708

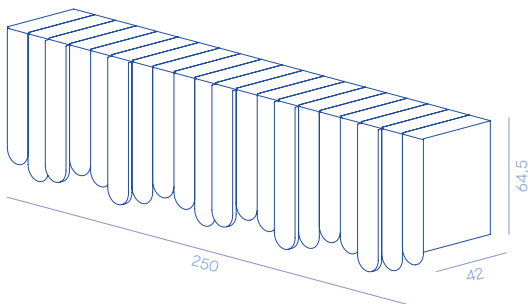

Xilo Console 300
DC709

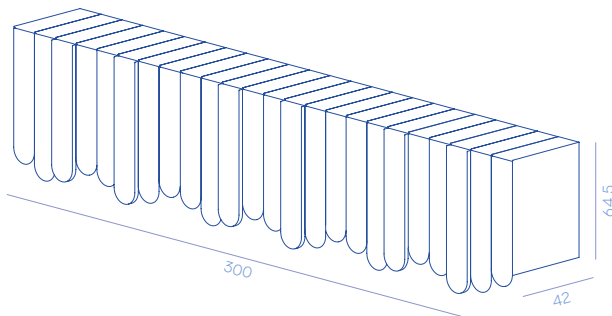

XILO CONSOLE 100

W. 100 D. 42 H. 64,5 cm

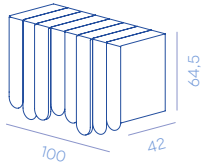

CODE / CODICE	IN	OUT	METAL FINISHES			EURO
DC705-E5	•		Stainless steel Acciaio inox	DeLabré B DeLabré B	E5	9.200,00
DC705-G2	•		Stainless steel Acciaio inox	Orbitale DeLabré DeLabré orbitale	G2	9.500,00
DC705-IX-MIX	•		Stainless steel Acciaio inox	MIX MIX	MIX	9.750,00
DC705-F2	•		Brass Ottone	DeLabré DeLabré	F2	11.200,00
DC705-G3	•		Brass Ottone	Orbitale DeLabré DeLabré orbitale	G3	15.500,00
DC705-OT-MIX	•		Brass Ottone	MIX MIX	MIX	11.950,00
DC705-G5	•		Copper Rame	DeLabré DeLabré	G5	12.200,00
DC705-G4	•		Copper Rame	Orbitale DeLabré DeLabré orbitale	G4	12.500,00
DC705-RA-MIX	•		Copper Rame	MIX MIX	MIX	13.000,00

kg 50 kg

kg 80 kg

cm W. 120 D. 62 H. 97 cm

m² 0,72 m²

N° 1

Excluding VAT
IVA esclusa

XILO CONSOLE 150

W. 150 D. 42 H. 64,5 cm

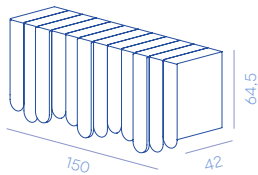

CODE / CODICE	IN	OUT	METAL FINISHES			EURO
DC706-E5	•		Stainless steel Acciaio inox	DeLabré B DeLabré B	E5	12.200,00
DC706-G2	•		Stainless steel Acciaio inox	Orbitale DeLabré DeLabré orbitale	G2	12.500,00
DC706-IX-MIX	•		Stainless steel Acciaio inox	MIX MIX	MIX	13.000,00
DC706-F2	•		Brass Ottone	DeLabré DeLabré	F2	14.200,00
DC706-G3	•		Brass Ottone	Orbitale DeLabré DeLabré orbitale	G3	14.500,00
DC706-OT-MIX	•		Brass Ottone	MIX MIX	MIX	15.000,00
DC706-G5	•		Copper Rame	DeLabré DeLabré	G5	15.600,00
DC706-G4	•		Copper Rame	Orbitale DeLabré DeLabré orbitale	G4	16.000,00
DC706-RA-MIX	•		Copper Rame	MIX MIX	MIX	16.400,00

kg 75 kg

kg 105 kg

cm W. 170 D. 62 H. 97 cm

m² 1,02 m²

N° 1

Excluding VAT
IVA esclusa

XILO CONSOLE 200

W. 200 D. 42 H. 64,5 cm

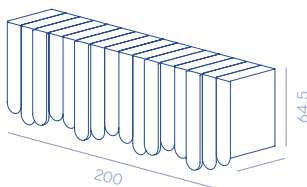

CODE / CODICE	IN	OUT	METAL FINISHES			EURO
DC707-E5	•		Stainless steel Acciaio inox	DeLabré B DeLabré B	E5	14.700,00
DC707-G2	•		Stainless steel Acciaio inox	Orbitale DeLabré DeLabré orbitale	G2	15.200,00
DC707-IX-MIX	•		Stainless steel Acciaio inox	MIX MIX	MIX	15.600,00
DC707-F2	•		Brass Ottone	DeLabré DeLabré	F2	17.000,00
DC707-G3	•		Brass Ottone	Orbitale DeLabré DeLabré orbitale	G3	17.500,00
DC707-OT-MIX	•		Brass Ottone	MIX MIX	MIX	18.000,00
DC707-G5	•		Copper Rame	DeLabré DeLabré	G5	18.400,00
DC707-G4	•		Copper Rame	Orbitale DeLabré DeLabré orbitale	G4	18.900,00
DC707-RA-MIX	•		Copper Rame	MIX MIX	MIX	19.400,00

kg 100 kg

kg 130 kg

cm W. 220 D. 62 H. 97 cm

m² 1,32 m²

N° 1

Excluding VAT
IVA esclusa

XILO CONSOLE 250

W. 250 D. 42 H. 64,5 cm

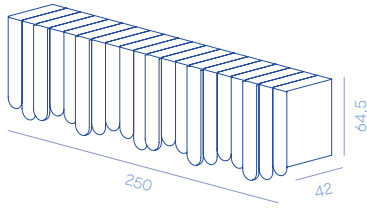

CODE / CODICE	IN	OUT	METAL FINISHES			EURO
DC708-E5	•		Stainless steel Acciaio inox	DeLabré B DeLabré B	E5	18.000,00
DC708-G2	•		Stainless steel Acciaio inox	Orbitale DeLabré DeLabré orbitale	G2	18.500,00
DC708-IX-MIX	•		Stainless steel Acciaio inox	MIX MIX	MIX	19.000,00
DC708-F2	•		Brass Ottone	DeLabré DeLabré	F2	20.500,00
DC708-G3	•		Brass Ottone	Orbitale DeLabré DeLabré orbitale	G3	21.000,00
DC708-OT-MIX	•		Brass Ottone	MIX MIX	MIX	21.700,00
DC708-G5	•		Copper Rame	DeLabré DeLabré	G5	21.900,00
DC708-G4	•		Copper Rame	Orbitale DeLabré DeLabré orbitale	G4	22.400,00
DC708-RA-MIX	•		Copper Rame	MIX MIX	MIX	23.000,00

kg 125 kg

kg 155 kg

cm W. 270 D. 62 H. 97 cm

m³ 1,57 m³

N° 1

Excluding VAT
IVA esclusa

XILO CONSOLE 300

W. 300 D. 42 H. 64,5 cm

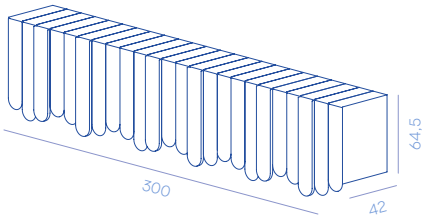

CODE / CODICE	IN	OUT	METAL FINISHES			EURO
DC709-E5	•		Stainless steel Acciaio inox	DeLabré B DeLabré B	E5	20.400,00
DC709-G2	•		Stainless steel Acciaio inox	Orbitale DeLabré DeLabré orbitale	G2	20.900,00
DC709-IX-MIX	•		Stainless steel Acciaio inox	MIX MIX	MIX	21.500,00
DC709-F2	•		Brass Ottone	DeLabré DeLabré	F2	23.200,00
DC709-G3	•		Brass Ottone	Orbitale DeLabré DeLabré orbitale	G3	23.700,00
DC709-OT-MIX	•		Brass Ottone	MIX MIX	MIX	24.500,00
DC709-G5	•		Copper Rame	DeLabré DeLabré	G5	24.800,00
DC709-G4	•		Copper Rame	Orbitale DeLabré DeLabré orbitale	G4	25.300,00
DC709-RA-MIX	•		Copper Rame	MIX MIX	MIX	25.800,00

kg 150 kg

kg 180 kg

cm W. 320 D. 62 H. 97 cm

m³ 1,92 m³

N° 1

Excluding VAT
IVA esclusa

Yoroi

DESIGN BY ALESSANDRO MASTURZO

Sideboard with 2 pull opening sides doors and 3 push and pull opening drawers, clad in metal on all sides.
Credenza con 2 ante laterali con apertura a tirare e 3 cassetti con apertura push and pull, rivestita in metallo su tutti i lati.

Yoroi
DC510

Closed / Chiuso

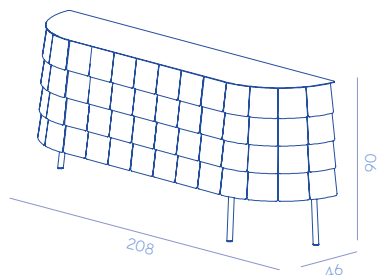

Open / Aperto

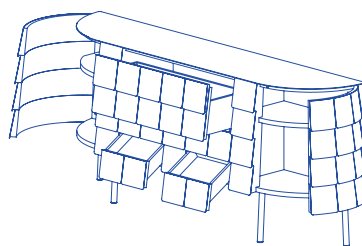

Internal measurements / Misure interne

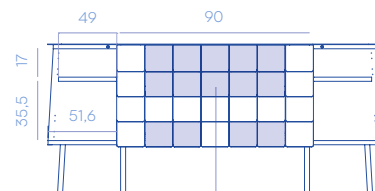

W. 80 D. 29 H. 22 cm

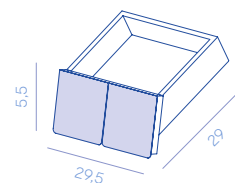

METAL FINISHES

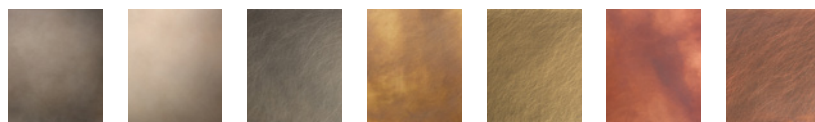

E5

E7

G2

F2

G3

G5

G4

PRODUCT SPECIFICATION

Structure	Natural oak wood 
Assembly	Shipped assembled
Packaging	Wooden crate included TYPE A
Details	<ul style="list-style-type: none"> - Clad in metal on all sides - The front is characterise by a metal scales cladding, the back by a flat metal sheet - Two sides doors with pull opening - 1 inner shelf per side - Equipped with one big drawer and two small inclined drawers with push and pull opening

SPECIFICHE PRODOTTO

Struttura	Natural oak wood 
Assemblaggio	Spedita montata
Imballo	Imballo in cassa incluso TIPO A
Dettagli	<ul style="list-style-type: none"> - Rivestito in metallo su tutti i lati - La parte anteriore è caratterizzata da un rivestimento in scaglie di metallo, la parte posteriore da una lamiera piana - Due ante laterali con apertura a tirare - 1 ripiano interno per lato - Dotato di un cassettone e due cassettoni inclinati con apertura push and pull

ON REQUEST

Finishes	<ul style="list-style-type: none"> - The product can also be made upon request, subject to confirmation of feasibility by De Castelli - Price is on request
Dimensions	<ul style="list-style-type: none"> - The product can also be made in dimensions on request, subject to confirmation of feasibility by De Castelli - It is possible to modify the length of the central body by adding or removing scales (16.7 cm), the sides doors can not be modified - For custom made products please specify the number of drawers as well as the dimensions, material and finishing - Price is on request

SU RICHIESTA

Finiture	<ul style="list-style-type: none"> - Il prodotto può essere realizzato anche in finiture su richiesta, previa conferma fattibilità da parte di De Castelli - Il prezzo è su richiesta
Dimensioni	<ul style="list-style-type: none"> - Il prodotto può essere realizzato anche in dimensioni a richiesta, previa conferma di fattibilità da parte De Castelli - E' possibile modificare la lunghezza del corpo centrale aggiungendo o togliendo scale (16,7 cm), le ante laterali non possono essere modificate - Per le realizzazioni su misura specificare il numero di cassetti nonché le dimensioni, il materiale e la finitura - Il prezzo è su richiesta

W. 208 D. 46 H. 90 cm

CODE / CODICE	IN	OUT	METAL FINISHES			EURO
DC510-E5	•		Stainless steel Acciaio inox	DeLabré B DeLabré B	E5	15.500,00
DC510-G2	•		Stainless steel Acciaio inox	Orbitale DeLabré DeLabré orbitale	G2	16.000,00
DC510-F2	•		Brass Ottone	DeLabré DeLabré	F2	16.900,00
DC510-G3	•		Brass Ottone	Orbitale DeLabré DeLabré orbitale	G3	17.200,00
DC510-G5	•		Copper Rame	DeLabré DeLabré	G5	18.300,00
DC510-G4	•		Copper Rame	Orbitale DeLabré DeLabré orbitale	G4	18.600,00

 128 kg

 155 kg

 W. 231 D. 91 H. 127 cm

 2,67 m³

 1

Excluding VAT
IVA esclusa

Bookcases
Librerie

Airframe

DESIGN BY PIO&TITOSO DESIGN

Self-standing bookcase/divider made entirely of brass and characterized by a frame of asymmetric elliptical rings partially clad in hand-domed metal sheets.

Libreria/divisorio self standing realizzata interamente in ottone e caratterizzata da un telaio di anelli ellittici asimmetrici e un rivestimento parziale in lastre bombate a mano.

Airframe
DC695

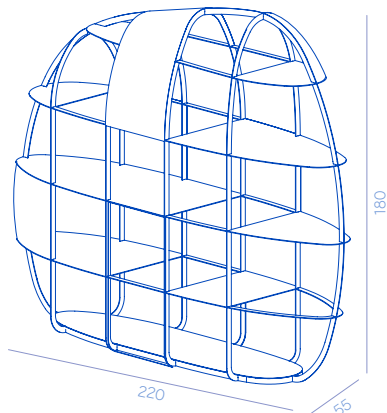

METAL FINISHES

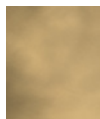

M9

PRODUCT SPECIFICATION

Assembly	Shipped assembled
Packaging	Wooden crate included TYPE A
Details	<ul style="list-style-type: none">- Self standing bookcase/divider entirely made of brass with four shelves, partially covered with handmade hammered metal sheets- Equipped with a ballast at the base to increase stability

SPECIFICHE PRODOTTO

Assemblaggio	Spedito montato
Imballo	Imballo in cassa incluso TIPO A
Dettagli	<ul style="list-style-type: none">- Libreria/divisorio self standing interamente realizzata in ottone con quattro ripiani, parzialmente rivestiti con lamiere martellate a mano- Dotata di zavorra alla base per aumentare la stabilità

ON REQUEST

Finishes	The product is available only in the finishes listed
Dimensions	The product is available only in the dimensions listed

SU RICHIESTA

Finiture	Il prodotto è disponibile solo nelle finiture previste
Dimensioni	Il prodotto è disponibile solo nelle dimensioni previste

AIRFRAME

W.220 D.55 H.180 cm

CODE / CODICE	IN	OUT	METAL FINISHES			EURO
DC695-M9	•		Brass Ottone	Brushed Spazzolato	M9	30.000,00

 130 kg

 175 kg

 W.239 D.74 H.212 cm

 3,75 m³

 1

Excluding VAT
IVA esclusa

Babele

DESIGN BY MARTINELLI VENEZIA

Circular, modular and self-standing bookcase entirely made of metal. It is available in two dimensional options.

Libreria circolare, modulare e self-standing interamente realizzata in metallo. Disponibile in due varianti dimensionali.

METAL FINISHES



E5

M9

G3

M7

M10

G4

PRODUCT SPECIFICATION

Structure	DeLabré M12 
Assembly	<ul style="list-style-type: none">- The product is shipped assembled up to three modules- Starting from the fourth module, the product is delivered in two or more boxes and assembly is required
Packaging	Carton box TIPO E
Details	<ul style="list-style-type: none">- Free standing bookcase entirely made of metal- Equipped with a ballast at the base to increase stability- Starting from 130 cm heights, the wall fixing system included is highly recommended

ON REQUEST

Finishes	<ul style="list-style-type: none">- The product can also be made in finishes on request, subject to confirmation of feasibility by De Castelli- Structure always in DeLabré M12- Price on request
Dimensions	The product is available only in the dimensions listed

SPECIFICHE PRODOTTO

Struttura	DeLabré M12 
Assemblaggio	<ul style="list-style-type: none">- Il prodotto viene spedito montato fino a tre moduli- A partire dal quarto modulo il prodotto viene consegnato in due o più scatole ed è necessario il montaggio
Imballo	Scatola di cartone TIPO E
Dettagli	<ul style="list-style-type: none">- Libreria free standing interamente realizzata in metallo- Dotata di zavorra alla base per aumentare la stabilità- A partire da altezze di 130 cm è vivamente consigliato il sistema di fissaggio a parete incluso

SU RICHIESTA

Finiture	<ul style="list-style-type: none">- Il prodotto può essere realizzato anche in finiture su richiesta, previa conferma fattibilità da parte di De Castelli- Struttura sempre in DeLabré M12- Prezzo su richiesta
Dimensioni	Il prodotto è disponibile solo nelle dimensioni previste

Diameter 28 cm / Diametro 28 cm

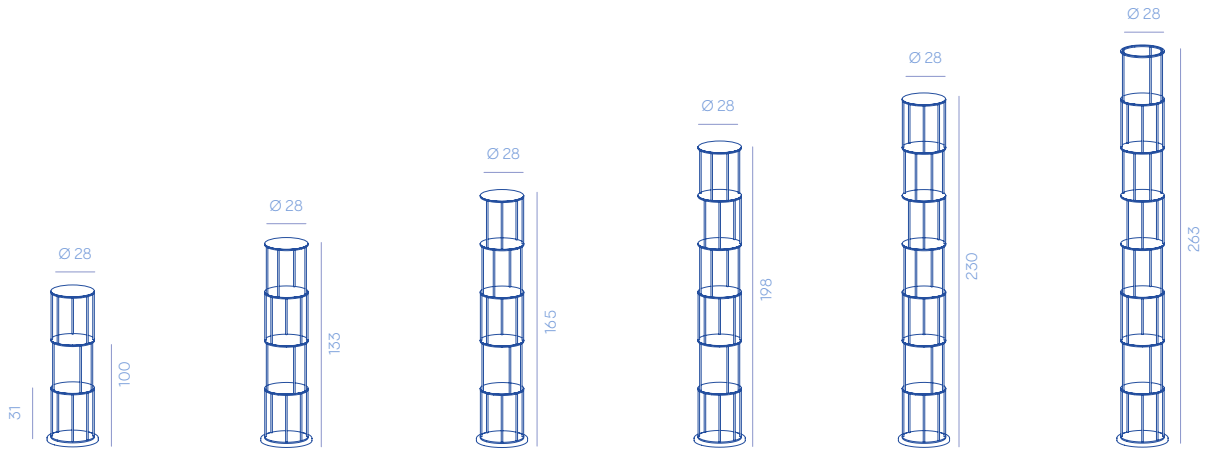

Babele 28 3 shelves
DC635-3M

Babele 28 4 shelves
DC635-4M

Babele 28 5 shelves
DC635-5M

Babele 28 6 shelves
DC635-6M

Babele 28 7 shelves
DC635-7M

Babele 28 8 shelves
DC635-8M

Diameter 36 cm / Diametro 36 cm

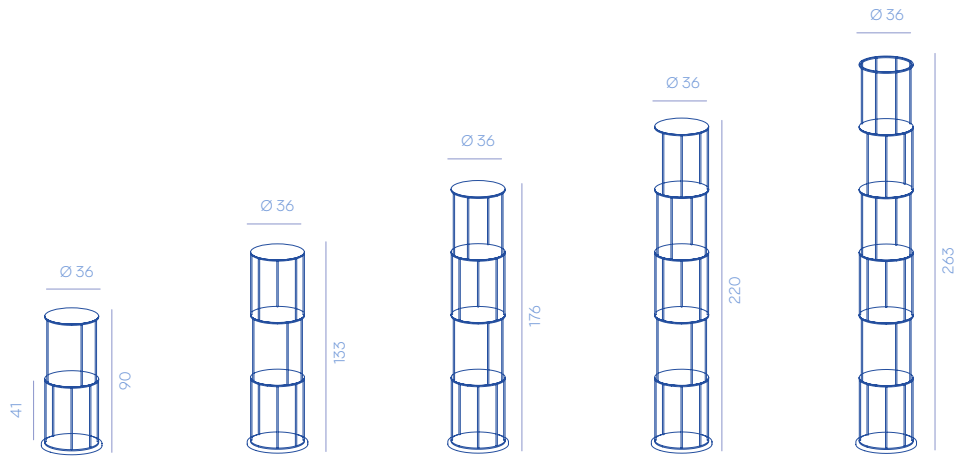

Babele 36 2 shelves
DC636-2M

Babele 36 3 shelves
DC636-3M

Babele 36 4 shelves
DC636-4M

Babele 36 5 shelves
DC636-5M

Babele 36 6 shelves
DC636-6M

BABELE 28 3M

Ø 28 H. 100 cm

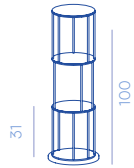

CODE / CODICE	IN	OUT	METAL FINISHES			EURO
DC635-3M-E5	•		Stainless steel Acciaio inox	DeLabré B DeLabré B	E5	2.200,00
DC635-3M-M9	•		Brass Ottone	Brushed Spazzolato	M9	2.300,00
DC635-3M-G3	•		Brass Ottone	Orbitale DeLabré DeLabré orbitale	G3	2.400,00
DC635-3M-M7	•		Brass Ottone	DeSalt DeSalt	M7	2.400,00
DC635-3M-M10	•		Copper Rame	Brushed Spazzolato	M10	2.530,00
DC635-3M-G4	•		Copper Rame	Orbitale DeLabré DeLabré orbitale	G4	2.650,00

21 kg

30 kg

W. 60 D. 80 H. 125 cm

0,6 m³

1

 Excluding VAT
IVA esclusa

BABELE 28 4M

Ø 28 H. 133 cm

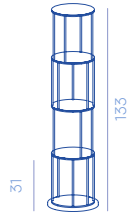

CODE / CODICE	IN	OUT	METAL FINISHES			EURO
DC635-4M-E5	•		Stainless steel Acciaio inox	DeLabré B DeLabré B	E5	2.760,00
DC635-4M-M9	•		Brass Ottone	Brushed Spazzolato	M9	2.880,00
DC635-4M-G3	•		Brass Ottone	Orbitale DeLabré DeLabré orbitale	G3	3.000,00
DC635-4M-M7	•		Brass Ottone	DeSalt DeSalt	M7	3.000,00
DC635-4M-M10	•		Copper Rame	Brushed Spazzolato	M10	3.300,00
DC635-4M-G4	•		Copper Rame	Orbitale DeLabré DeLabré orbitale	G4	3.400,00

23 kg

38 kg

W. 60 D. 80 H. 156 cm

0,75 m³

1

 Excluding VAT
IVA esclusa

BABELE 28 5M

Ø 28 H. 165 cm

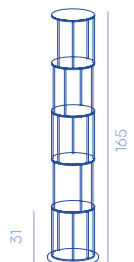

CODE / CODICE	IN	OUT	METAL FINISHES			EURO
DC635-5M-E5	•		Stainless steel Acciaio inox	DeLabré B DeLabré B	E5	3.250,00
DC635-5M-M9	•		Brass Ottone	Brushed Spazzolato	M9	3.380,00
DC635-5M-G3	•		Brass Ottone	Orbitale DeLabré DeLabré orbitale	G3	3.500,00
DC635-5M-M7	•		Brass Ottone	DeSalt DeSalt	M7	3.500,00
DC635-5M-M10	•		Copper Rame	Brushed Spazzolato	M10	3.800,00
DC635-5M-G4	•		Copper Rame	Orbitale DeLabré DeLabré orbitale	G4	3.900,00

26 kg

43 kg

W. 60 D. 80 H. 125 cm

0,60 m³/cad

2

 Excluding VAT
IVA esclusa

BABELE 28 6M

Ø 28 H. 198 cm

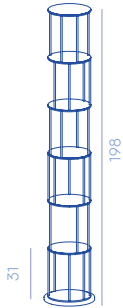

CODE / CODICE	IN	OUT	METAL FINISHES			EURO
DC635-6M-E5	•		Stainless steel Acciaio inox	DeLabré B DeLabré B	E5	3.700,00
DC635-6M-M9	•		Brass Ottone	Brushed Spazzolato	M9	3.850,00
DC635-6M-G3	•		Brass Ottone	Orbitale DeLabré DeLabré orbitale	G3	4.000,00
DC635-6M-M7	•		Brass Ottone	DeSalt DeSalt	M7	4.000,00
DC635-6M-M10	•		Copper Rame	Brushed Spazzolato	M10	4.150,00
DC635-6M-G4	•		Copper Rame	Orbitale DeLabré DeLabré orbitale	G4	4.300,00

kg 27,5 kg

kg 43 kg

cm W. 60 D. 80 H. 125 cm

m³ 0,60 m³/cad

N° 2

Excluding VAT
IVA esclusa

BABELE 28 7M

Ø 28 H. 230 cm

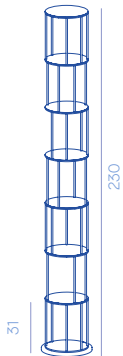

CODE / CODICE	IN	OUT	METAL FINISHES			EURO
DC635-7M-E5	•		Stainless steel Acciaio inox	DeLabré B DeLabré B	E5	4.100,00
DC635-7M-M9	•		Brass Ottone	Brushed Spazzolato	M9	4.300,00
DC635-7M-G3	•		Brass Ottone	Orbitale DeLabré DeLabré orbitale	G3	4.500,00
DC635-7M-M7	•		Brass Ottone	DeSalt DeSalt	M7	4.500,00
DC635-7M-M10	•		Copper Rame	Brushed Spazzolato	M10	4.700,00
DC635-7M-G4	•		Copper Rame	Orbitale DeLabré DeLabré orbitale	G4	4.800,00

kg 29,5 kg

kg 44,5 kg

cm W. 60 D. 80 H. 156 cm

m³ 0,75 m³/cad

N° 2

Excluding VAT
IVA esclusa

BABELE 28 8M

Ø 28 H. 263cm

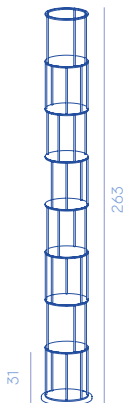

CODE / CODICE	IN	OUT	METAL FINISHES			EURO
DC635-8M-E5	•		Stainless steel Acciaio inox	DeLabré B DeLabré B	E5	4.370,00
DC635-8M-M9	•		Brass Ottone	Brushed Spazzolato	M9	4.570,00
DC635-8M-G3	•		Brass Ottone	Orbitale DeLabré DeLabré orbitale	G3	4.770,00
DC635-8M-M7	•		Brass Ottone	DeSalt DeSalt	M7	4.770,00
DC635-8M-M10	•		Copper Rame	Brushed Spazzolato	M10	5.000,00
DC635-8M-G4	•		Copper Rame	Orbitale DeLabré DeLabré orbitale	G4	5.200,00

kg 31 kg

kg 47 kg

cm W. 60 D. 80 H. 156 cm

m³ 0,75 m³/cad

N° 2

Excluding VAT
IVA esclusa

BABELE 36 2M

Ø 36 H. 90 cm

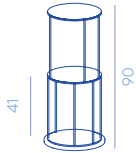

CODE / CODICE	IN	OUT	METAL FINISHES			EURO
DC636-2M-E5	•		Stainless steel Acciaio inox	DeLabré B DeLabré B	E5	2.050,00
DC636-2M-M9	•		Brass Ottone	Brushed Spazzolato	M9	2.100,00
DC636-2M-G3	•		Brass Ottone	Orbitale DeLabré DeLabré orbitale	G3	2.200,00
DC636-2M-M7	•		Brass Ottone	DeSalt DeSalt	M7	2.200,00
DC636-2M-M10	•		Copper Rame	Brushed Spazzolato	M10	2.350,00
DC636-2M-G4	•		Copper Rame	Orbitale DeLabré DeLabré orbitale	G4	2.450,00

kg 29,5 kg

kg 42 kg

cm W. 60 D. 80 H. 115 cm

m³ 0,55 m³

N° 1

Excluding VAT
IVA esclusa

BABELE 36 3M

Ø 36 H. 133 cm

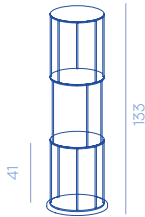

CODE / CODICE	IN	OUT	METAL FINISHES			EURO
DC636-3M-E5	•		Stainless steel Acciaio inox	DeLabré B DeLabré B	E5	2.650,00
DC636-3M-M9	•		Brass Ottone	Brushed Spazzolato	M9	2.700,00
DC636-3M-G3	•		Brass Ottone	Orbitale DeLabré DeLabré orbitale	G3	2.800,00
DC636-3M-M7	•		Brass Ottone	DeSalt DeSalt	M7	2.800,00
DC636-3M-M10	•		Copper Rame	Brushed Spazzolato	M10	2.850,00
DC636-3M-G4	•		Copper Rame	Orbitale DeLabré DeLabré orbitale	G4	2.950,00

kg 32 kg

kg 45 kg

cm W. 60 D. 80 H. 156 cm

m³ 0,75 m³

N° 1

Excluding VAT
IVA esclusa

BABELE 36 4M

Ø 36 H. 176 cm

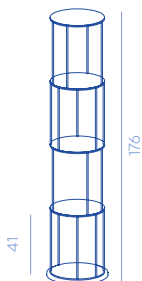

CODE / CODICE	IN	OUT	METAL FINISHES			EURO
DC636-4M-E5	•		Stainless steel Acciaio inox	DeLabré B DeLabré B	E5	3.050,00
DC636-4M-M9	•		Brass Ottone	Brushed Spazzolato	M9	3.100,00
DC636-4M-G3	•		Brass Ottone	Orbitale DeLabré DeLabré orbitale	G3	3.200,00
DC636-4M-M7	•		Brass Ottone	DeSalt DeSalt	M7	3.200,00
DC636-4M-M10	•		Copper Rame	Brushed Spazzolato	M10	3.250,00
DC636-4M-G4	•		Copper Rame	Orbitale DeLabré DeLabré orbitale	G4	3.350,00

kg 35 kg

kg 48 kg

cm W. 60 D. 80 H. 200 cm

m³ 0,96 m³

N° 1

Excluding VAT
IVA esclusa

BABELE 36 5M

Ø 36 H. 220 cm

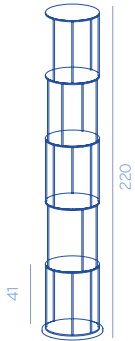

CODE / CODICE	IN	OUT	METAL FINISHES			EURO
DC636-5M-E5	•		Stainless steel Acciaio inox	DeLabré B DeLabré B	E5	3.500,00
DC636-5M-M9	•		Brass Ottone	Brushed Spazzolato	M9	3.550,00
DC636-5M-G3	•		Brass Ottone	Orbitale DeLabré DeLabré orbitale	G3	3.650,00
DC636-5M-M7	•		Brass Ottone	DeSalt DeSalt	M7	3.650,00
DC636-5M-M10	•		Copper Rame	Brushed Spazzolato	M10	3.750,00
DC636-5M-G4	•		Copper Rame	Orbitale DeLabré DeLabré orbitale	G4	3.850,00

kg 37,5 kg

kg 50 kg

cm W. 120 D. 80 H. 156 cm

m³ 1,45 m³/cad

N° 2

Excluding VAT
IVA esclusa

BABELE 36 6M

Ø 36 H. 263 cm

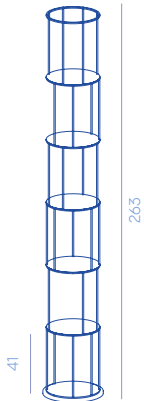

CODE / CODICE	IN	OUT	METAL FINISHES			EURO
DC636-6M-E5	•		Stainless steel Acciaio inox	DeLabré B DeLabré B	E5	4.000,00
DC636-6M-M9	•		Brass Ottone	Brushed Spazzolato	M9	4.050,00
DC636-6M-G3	•		Brass Ottone	Orbitale DeLabré DeLabré orbitale	G3	4.150,00
DC636-6M-M7	•		Brass Ottone	DeSalt DeSalt	M7	4.150,00
DC636-6M-M10	•		Copper Rame	Brushed Spazzolato	M10	4.300,00
DC636-6M-G4	•		Copper Rame	Orbitale DeLabré DeLabré orbitale	G4	4.400,00

kg 40 kg

kg 52 kg

cm W. 120 D. 80 H. 156 cm

m³ 1,45 m³

N° 2

Excluding VAT
IVA esclusa

Existence round

DESIGN BY MICHELE DE LUCCHI

Free-standing modular bookcase entirely made of metal. It can be composed of 1 module up to 7 modules.

Libreria componibile free-standing interamente realizzata in metallo. Può essere composta da 1 modulo fino a 7 moduli.

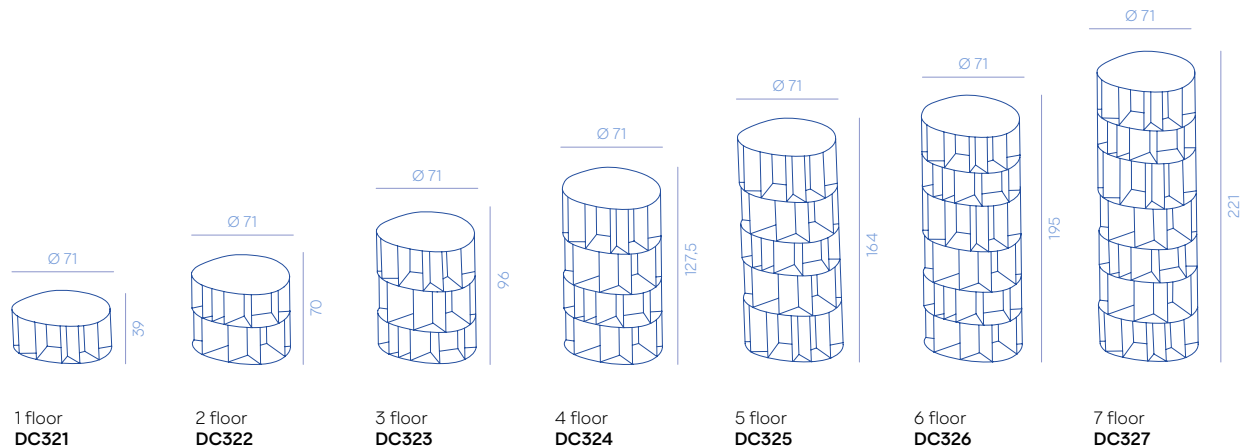

METAL FINISHES



E5

G3

PRODUCT SPECIFICATION

Assembly	Shipped disassembled
Packaging	Wooden cage included TYPE C
Details	<ul style="list-style-type: none"> - Free standing bookcase entirely made of metal - Order installation from bottom to top

ON REQUEST

Finishes	The product is available only in the finishes listed
Dimensions	<ul style="list-style-type: none"> - The product can also be custom made in dimensions on request, subject to confirmation of feasibility by De Castelli - When requesting, please specify the desired number of shelves in addition to dimensions, material and finishing - Price on request

SPECIFICHE PRODOTTO

Assemblaggio	Spedito smontato
Imballo	Imballo in gabbia incluso TIPO C
Dettagli	<ul style="list-style-type: none"> - Libreria free standing interamente realizzata in metallo - Ordine di installazione dal basso verso l'alto

SU RICHIESTA

Finiture	Il prodotto è disponibile solo nelle finiture previste
Dimensioni	<ul style="list-style-type: none"> - Il prodotto può essere realizzato anche in dimensioni su richiesta, previa conferma fattibilità da parte di De Castelli - In fase di richiesta specificare oltre alle dimensioni, al materiale e alla finitura, anche il numero di ripiani desiderati - Prezzo su richiesta

EXISTENCE ROUND 1M

W. 71 D. 61 H. 39 cm

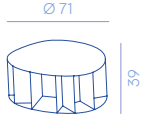

CODE / CODICE	IN	OUT	METAL FINISHES			EURO
DC321-E5	•		Stainless steel Acciaio inox	DeLabré B DeLabré B	E5	3.100,00
DC321-G3	•		Brass Ottone	Orbitale DeLabré DeLabré orbitale	G3	4.400,00

kg 36 kg
 kg 54 kg
 cm W. 100 D. 100 H. 104 cm
 m³ 1,04 m³
 N° 1
 Excluding VAT
IVA esclusa

EXISTENCE ROUND 2M

W. 71 D. 61 H. 70 cm

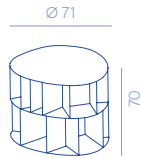

CODE / CODICE	IN	OUT	METAL FINISHES			EURO
DC322-E5	•		Stainless steel Acciaio inox	DeLabré B DeLabré B	E5	4.980,00
DC322-G3	•		Brass Ottone	Orbitale DeLabré DeLabré orbitale	G3	7.200,00

kg 63 kg
 kg 54 kg
 cm W. 80 D. 80 H. 93 cm
 m³ 0,60 m³
 N° 1
 Excluding VAT
IVA esclusa

EXISTENCE ROUND 3M

W. 71 D. 61 H. 96 cm

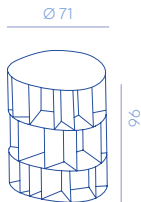

CODE / CODICE	IN	OUT	METAL FINISHES			EURO
DC323-E5	•		Stainless steel Acciaio inox	DeLabré B DeLabré B	E5	5.800,00
DC323-G3	•		Brass Ottone	Orbitale DeLabré DeLabré orbitale	G3	9.800,00

kg 86 kg
 kg 105 kg
 cm W. 100 D. 100 H. 148 cm
 m³ 1,48 m³
 N° 1
 Excluding VAT
IVA esclusa

EXISTENCE ROUND 4M

W. 71 D. 61 H. 127,5 cm

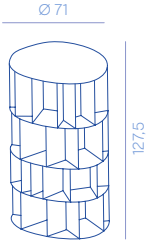

CODE / CODICE	IN	OUT	METAL FINISHES			EURO
DC324-E5	•		Stainless steel Acciaio inox	DeLabré B DeLabré B	E5	8.800,00
DC324-G3	•		Brass Ottone	Orbitale DeLabré DeLabré orbitale	G3	12.500,00

kg 120 kg
 kg 150 kg
 cm W. 120 D. 80 H. 104 cm
 m³ 1 m³
 Nº 1
 Excluding VAT
IVA esclusa

EXISTENCE ROUND 5M

W. 71 D. 61 H. 164 cm

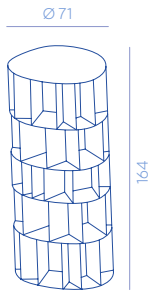

CODE / CODICE	IN	OUT	METAL FINISHES			EURO
DC325-E5	•		Stainless steel Acciaio inox	DeLabré B DeLabré B	E5	10.000,00
DC325-G3	•		Brass Ottone	Orbitale DeLabré DeLabré orbitale	G3	16.000,00

kg 165 kg
 kg 190 kg
 cm W. 120 D. 80 H. 148 cm
 m³ 1,45m³/cad
 Nº 2
 Excluding VAT
IVA esclusa

EXISTENCE ROUND 6M

W. 71 D. 61 H. 195 cm

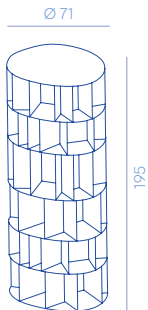

CODE / CODICE	IN	OUT	METAL FINISHES			EURO
DC326-E5	•		Stainless steel Acciaio inox	DeLabré B DeLabré B	E5	11.200,00
DC326-G3	•		Brass Ottone	Orbitale DeLabré DeLabré orbitale	G3	17.800,00

kg 180 kg
 kg 200 kg
 cm W. 120 D. 80 H. 148 cm
 m³ 1,45 m³/cad
 Nº 2
 Excluding VAT
IVA esclusa

EXISTENCE ROUND 7M

W. 71 D. 61 H. 221 cm

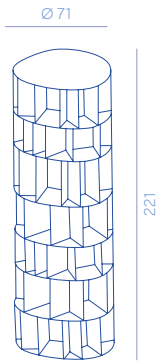

CODE / CODICE	IN	OUT	METAL FINISHES			EURO
DC321-E5	•		Stainless steel Acciaio inox	DeLabré B DeLabré B	E5	14.500,00
DC321-G3	•		Brass Ottone	Orbitale DeLabré DeLabré orbitale	G3	21.500,00

kg 190 kg

kg 210 kg

cm W. 120 D. 80 H. 192 cm

m³ 1,85 m³

N° 2

Excluding VAT
IVA esclusa

Existence wall

DESIGN BY MICHELE DE LUCCHI

Wall-mounted modular bookcase entirely made of metal. It can be composed of 1 module up to 5 modules.

Libreria componibile a parete interamente realizzata in metallo. Può essere composta da 1 modulo fino a 5 moduli.

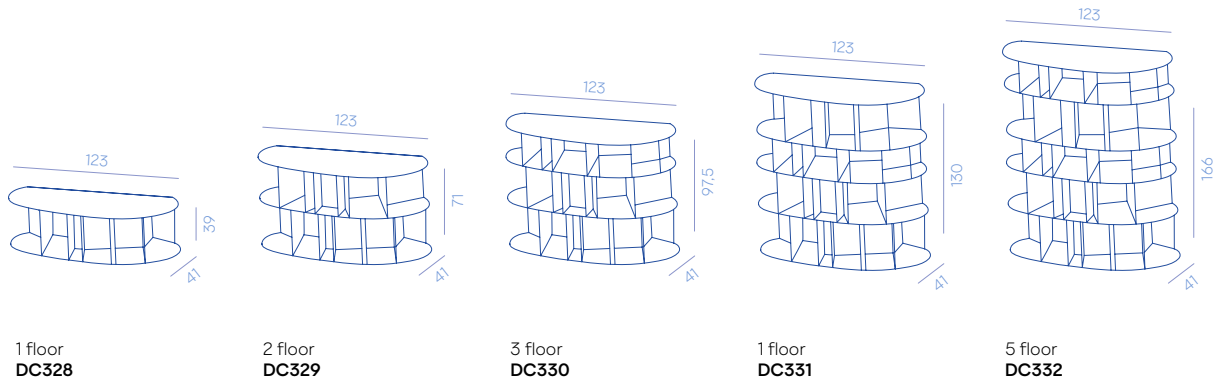

METAL FINISHES



E5

G3

PRODUCT SPECIFICATION

Assembly	Shipped disassembled
Packaging	Wooden cage included TYPE C
Details	<ul style="list-style-type: none"> - Free standing bookcase entirely made of metal - Order installation from bottom to top

SPECIFICHE PRODOTTO

Assemblaggio	Spedito smontato
Imballo	Imballo in gabbia incluso TIPO C
Dettagli	<ul style="list-style-type: none"> - Libreria free standing interamente realizzata in metallo - Ordine di installazione dal basso verso l'alto - È necessaria una parete portante o un cartongesso rinforzato

ON REQUEST

Finishes	The product is available only in the finishes listed
Dimensions	<ul style="list-style-type: none"> - The product can also be custom made in dimensions on request, subject to confirmation of feasibility by De Castelli - When requesting, please specify the desired number of shelves in addition to dimensions, material and finishing - Price on request

SU RICHIESTA

Finiture	Il prodotto è disponibile solo nelle finiture previste
Dimensioni	<ul style="list-style-type: none"> - Il prodotto può essere realizzato anche in dimensioni su richiesta, previa conferma fattibilità da parte di De Castelli - In fase di richiesta specificare oltre alle dimensioni, al materiale e alla finitura, anche il numero di ripiani desiderati - Prezzo su richiesta

EXISTENCE WALL 1M

W. 123 D. 41 H. 39 cm

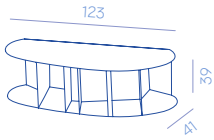

CODE / CODICE	IN	OUT	METAL FINISHES			EURO
DC328-E5	•		Stainless steel Acciaio inox	DeLabré B DeLabré B	E5	4.300,00
DC328-G3	•		Brass Ottone	Orbitale DeLabré DeLabré orbitale	G3	6.000,00

kg 50 kg
kg 70 kg
cm W. 150 D. 80 H. 66 cm
m³ 0,80 m³
Nº 1
Excluding VAT IVA esclusa

EXISTENCE WALL 2M

W. 123 D. 41 H. 71 cm

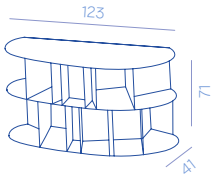

CODE / CODICE	IN	OUT	METAL FINISHES			EURO
DC329-E5	•		Stainless steel Acciaio inox	DeLabré B DeLabré B	E5	5.800,00
DC329-G3	•		Brass Ottone	Orbitale DeLabré DeLabré orbitale	G3	9.800,00

kg 82 kg
kg 100 kg
cm W. 150 D. 92 H. 66 cm
m³ 0,95 m³
Nº 1
Excluding VAT IVA esclusa

EXISTENCE WALL 3M

W. 123 D. 41 H. 97,5 cm

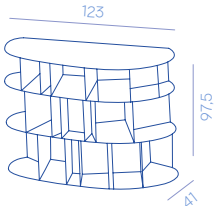

CODE / CODICE	IN	OUT	METAL FINISHES			EURO
DC330-E5	•		Stainless steel Acciaio inox	DeLabré B DeLabré B	E5	8.400,00
DC330-G3	•		Brass Ottone	Orbitale DeLabré DeLabré orbitale	G3	13.500,00

kg 117 kg
kg 137 kg
cm W. 150 D. 92 H. 116 cm
m³ 1,60 m³
Nº 1
Excluding VAT IVA esclusa

EXISTENCE WALL 4M

W. 123 D. 41 H. 130 cm

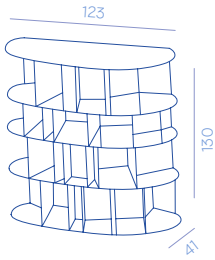

CODE / CODICE	IN	OUT	METAL FINISHES			EURO
DC331-E5	•		Stainless steel Acciaio inox	DeLabré B DeLabré B	E5	10.500,00
DC331-G3	•		Brass Ottone	Orbitale DeLabré DeLabré orbitale	G3	15.800,00

kg 150 kg
 kg 170 kg
 cm W. 150 D. 92 H. 116 cm
 m³ 2,20 m³
 N° 1
 Excluding VAT
IVA esclusa

EXISTENCE WALL 5M

W. 123 D. 41 H. 166 cm

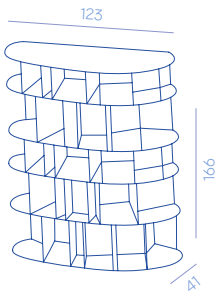

CODE / CODICE	IN	OUT	METAL FINISHES			EURO
DC332-E5	•		Stainless steel Acciaio inox	DeLabré B DeLabré B	E5	13.500,00
DC332-G3	•		Brass Ottone	Orbitale DeLabré DeLabré orbitale	G3	19.000,00

kg 185 kg
 kg 200 kg
 cm W. 150 D. 92 H. 148 cm
 m³ 2,05 m³
 N° 1
 Excluding VAT
IVA esclusa

Nami

DESIGN BY ANDREA PARISIO

Self-standing bookcase entirely made of stainless steel and characterized by a decorative band available in stainless steel, brass or copper in striped DeLabré finishing.

Libreria self-standing interamente realizzata in acciaio inox e caratterizzata da una fascia decorativa disponibile in acciaio inox, ottone o rame in finitura DeLabré striato.

Nami
DC489

Compositions / Composizioni

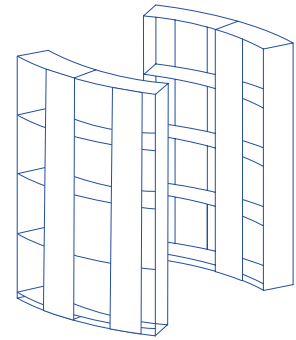
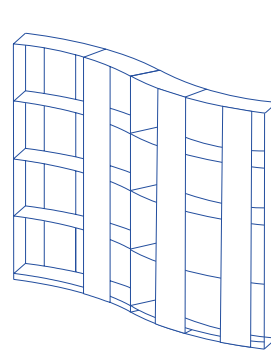
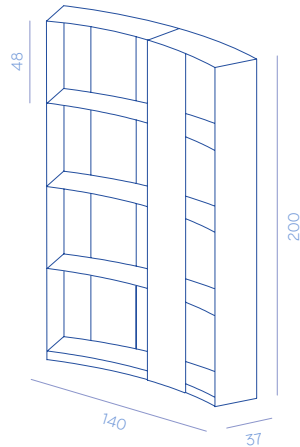

METAL FINISHES

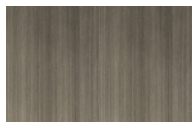

E6+E6



E6+G7



E6+G6

PRODUCT SPECIFICATION

Structure	Striped DeLabré stainless steel E6
Assembly	Shipped assembled
Packaging	Wooden crate included TYPE A
Details	<ul style="list-style-type: none">- C-shape self standing bookcase entirely made of metal- The structure is always in striped DeLabré stainless steel E6 and can't be changed

ON REQUEST

Finishes	<ul style="list-style-type: none">- The decorative stripe can also be made in finishes on request, subject to confirmation of feasibility by De Castelli, structure finishing can not be changed- Price on request
Dimensions	<ul style="list-style-type: none">- The product can also be custom made in dimensions on request, subject to confirmation of feasibility by De Castelli- When requesting, please specify the desired number of shelves as well as dimensions, material and finishing of the decorative stripe- Price on request

SPECIFICHE PRODOTTO

Struttura	Acciaio inox DeLabré striato E6
Assemblaggio	Spedito montato
Imballo	Imballo in cassa incluso TIPO A
Dettagli	<ul style="list-style-type: none">- Libreria self standing a forma di C interamente realizzata in metallo- La struttura è sempre in acciaio inox DeLabré striato E6 e non può essere modificata

SU RICHIESTA

Finiture	<ul style="list-style-type: none">- La fascia decorativa può essere realizzata anche in finiture a richiesta, previa conferma di fattibilità da parte di De Castelli, la finitura della struttura non può essere modificata- Prezzo su richiesta
Dimensioni	<ul style="list-style-type: none">- La fascia decorativa può essere realizzata anche in finiture a richiesta, previa conferma di fattibilità da parte di De Castelli, la finitura della struttura non può essere modificata- In fase di richiesta specificare oltre alle dimensioni, al materiale e alla finitura, anche il numero di ripiani desiderati- Prezzo su richiesta

NAMI

W. 140 D. 37 H. 200 cm

CODE / CODICE	IN	OUT	METAL FINISHES			EURO
DC489-E6	•		Stainless steel Acciaio inox	Striped DeLabré DeLabré striato	E6	17.500,00
DC489-G7	•		Brass Ottone	Striped DeLabré DeLabré striato	G7	18.500,00
DC489-G6	•		Rame Copper	Striped DeLabré DeLabré striato	G6	19.500,00

 200 kg

 230 kg

 W. 94 D. 174 H. 232 cm

 3,80 m³

 1

Excluding VAT
IVA esclusa

Nippon

DESIGN BY ALBERTO NASON

Wall bookcase entirely of metal, supplied with wall fixing system.

Libreria da parete interamente in metallo, completa di fissaggio a muro.

Nippon
DC488

Detailed measurements / Misure di dettaglio

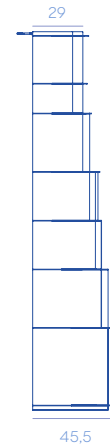
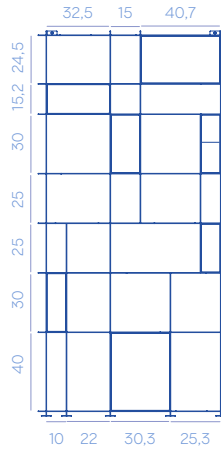
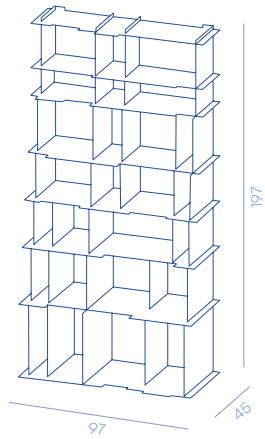

METAL FINISHES

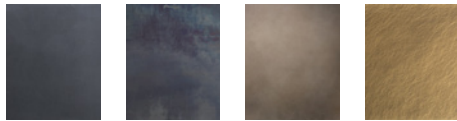

E3

G1

E5

G3

PRODUCT SPECIFICATION

Assembly	Shipped assembled
Packaging	Wooden crate included TYPE A
Details	<ul style="list-style-type: none"> – Wall bookcase entirely made of metal – The wall fixing system included is highly recommended

SPECIFICHE PRODOTTO

Assemblaggio	Spedito montato
Imballo	Imballo in cassa incluso TIPO A
Dettagli	<ul style="list-style-type: none"> – Libreria a parete interamente realizzata in metallo – Il sistema di fissaggio a parete è altamente consigliato

ON REQUEST

Finishes	The product is available only in the finishes listed
Dimensions	<ul style="list-style-type: none"> – The product can also be custom made in dimensions on request, subject to confirmation of feasibility by De Castelli – When requesting, please specify the desired number of shelves as well as dimensions, material and finishing – Price on request

SU RICHIESTA

Finiture	Il prodotto è disponibile solo nelle finiture previste
Dimensioni	<ul style="list-style-type: none"> – Il prodotto può essere realizzato anche in dimensioni su richiesta, previa conferma fattibilità da parte di De Castelli – In fase di richiesta specificare oltre alle dimensioni, al materiale e alla finitura, anche il numero di ripiani desiderati – Prezzo su richiesta

NIPPON

W. 97 D. 45 H. 197 cm

CODE / CODICE	IN	OUT	METAL FINISHES			EURO
DC488-E3	•		Black iron Lamiera nera	Natural Naturale	E3	4.500,00
DC488-G1	•		Black iron Lamiera nera	DeLabré DeLabré	G1	6.000,00
DC488-E5	•		Stainless steel Acciaio inox	DeLabré B DeLabré B	E5	7.800,00
DC488-G3	•		Brass Ottone	Orbitale DeLabré DeLabré orbitale	G3	15.700,00

 145 kg

 160 kg

 W. 116 D. 65 H. 229 cm

 1,75 m³

 1

Excluding VAT
IVA esclusa

Talea

DESIGN BY LUCIDIPEVERE

Wall and ceiling mounted modular bookshelf characterized by metal brackets and wooden shelves.
Libreria con fissaggio a parete e soffitto caratterizzata da montanti in metallo e mensole in legno.

METAL FINISHES



G2

G3

G4

PRODUCT SPECIFICATION

Shelf	Gabon ebony 
Assembly	Shipped disassembled
Packaging	Wooden crate included TYPE A
Details	<ul style="list-style-type: none">- Modular bookcase with metal uprights- Weight capacity 30kg each shelf- Load-bearing wall and ceiling or reinforced plasterboard is required- Ceiling fixing system to be included in the quotation, fixing screws excluded

ON REQUEST

Finishes	The product is available only in the finishes listed
Dimensions	<ul style="list-style-type: none">- It is possible to lengthen or shorten the wooden shelves only- The distance between the uprights is fixed- Price on request

SPECIFICHE PRODOTTO

Mensola	Ebano gabon 
Assemblaggio	Spedito smontato
Imballo	Imballo in cassa incluso TIPO A
Dettagli	<ul style="list-style-type: none">- Libreria componibile con montanti in metallo- Portata 30kg per ripiano- Sono necessari una parete portante o un cartongesso rinforzato e un soffitto rinforzato- Sistema di fissaggio a parete da includere nella quotazione, viti di fissaggio escluse

SU RICHIESTA

Finiture	Il prodotto è disponibile solo nelle finiture previste
Dimensioni	<ul style="list-style-type: none">- È possibile allungare o accorciare le sole mensole in legno- La distanza fra i montanti è fissa- Prezzo su richiesta

Talea 115
DC650

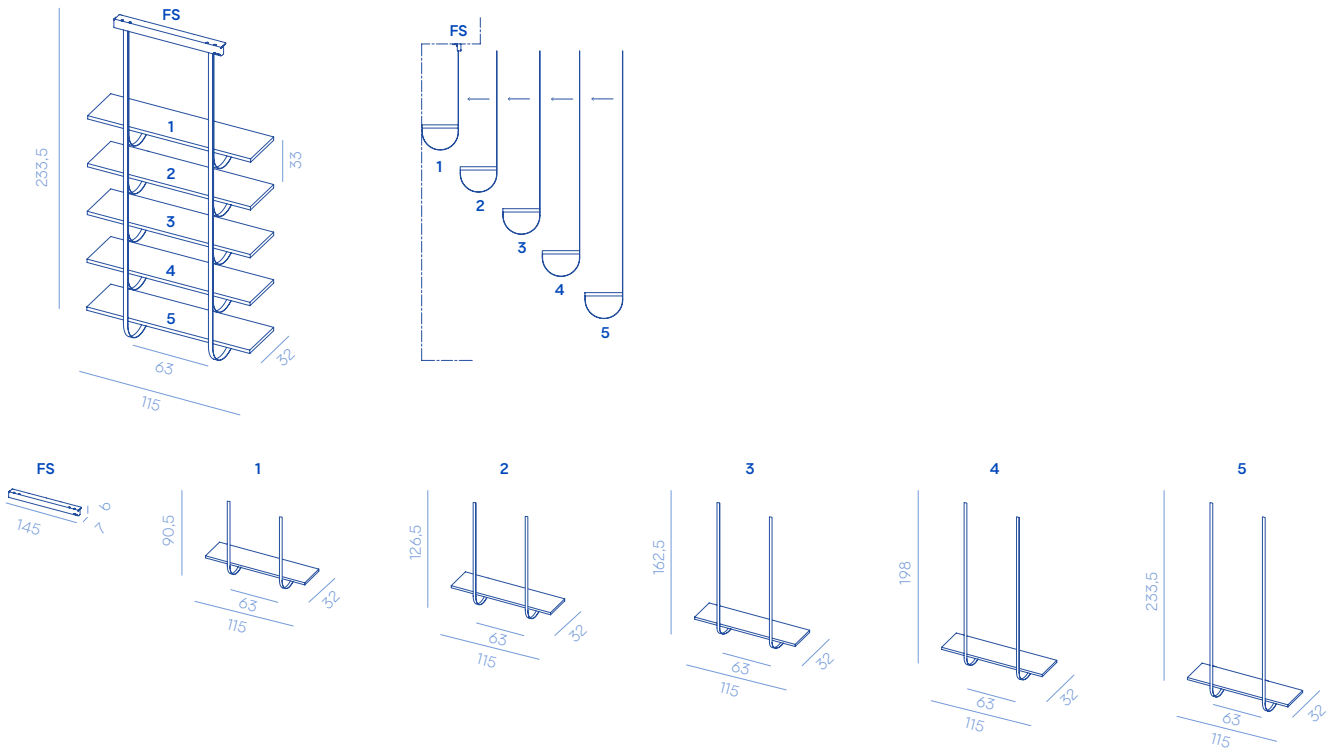

Talea 185
DC651

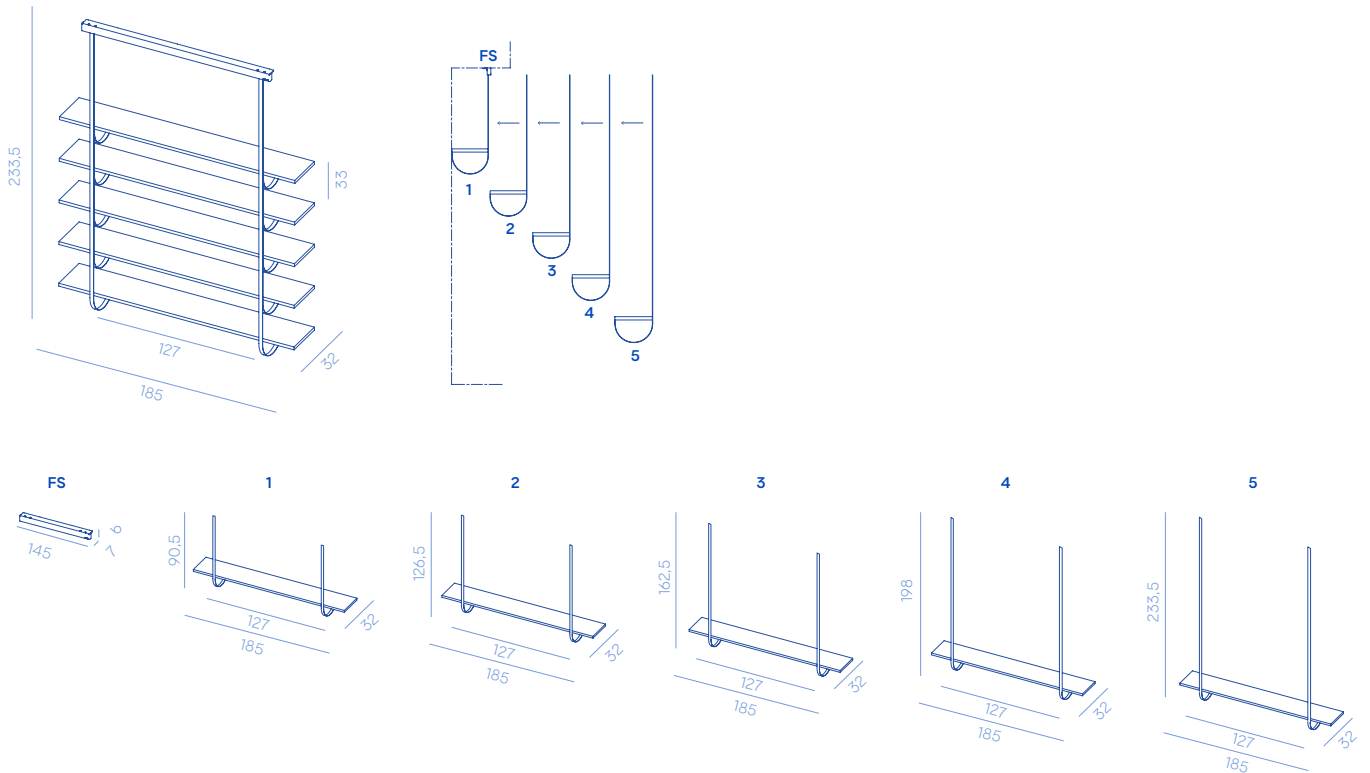

TALEA 115 SHELF 1

W. 115 D. 32 H. 90,5 cm

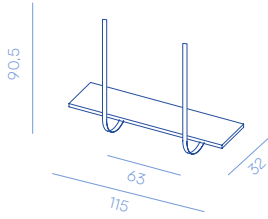

CODE / CODICE	IN	OUT	METAL FINISHES			EURO
DC650-100-G2	•		Stainless steel Acciaio inox	Orbitale DeLabré DeLabré orbitale	G2	1.480,00
DC650-100-G3	•		Brass Ottone	Orbitale DeLabré DeLabré orbitale	G3	1.580,00
DC650-100-G4	•		Copper Rame	Orbitale DeLabré DeLabré orbitale	G4	1.640,00

kg 7,5 kg

kg 14 kg

cm W. 262 D. 80 H. 40 cm

m³ 0,85 m³

N° 1

Excluding VAT
IVA esclusa

TALEA 115 SHELF 2

W. 115 D. 32 H. 126,5 cm

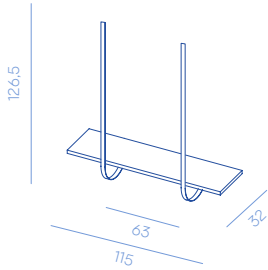

CODE / CODICE	IN	OUT	METAL FINISHES			EURO
DC650-200-G2	•		Stainless steel Acciaio inox	Orbitale DeLabré DeLabré orbitale	G2	1.560,00
DC650-200-G3	•		Brass Ottone	Orbitale DeLabré DeLabré orbitale	G3	1.680,00
DC650-200-G4	•		Copper Rame	Orbitale DeLabré DeLabré orbitale	G4	1.740,00

kg 8 kg

kg 15 kg

cm W. 262 D. 80 H. 45 cm

m³ 0,95 m³

N° 1

Excluding VAT
IVA esclusa

TALEA 115 SHELF 3

W. 115 D. 32 H. 162,5 cm

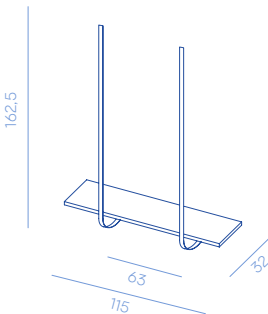

CODE / CODICE	IN	OUT	METAL FINISHES			EURO
DC650-300-G2	•		Stainless steel Acciaio inox	Orbitale DeLabré DeLabré orbitale	G2	1.700,00
DC650-300-G3	•		Brass Ottone	Orbitale DeLabré DeLabré orbitale	G3	1.800,00
DC650-300-G4	•		Copper Rame	Orbitale DeLabré DeLabré orbitale	G4	1.880,00

kg 8,5 kg

kg 16 kg

cm W. 262 D. 80 H. 50 cm

m³ 1,05 m³

N° 1

Excluding VAT
IVA esclusa

TALEA 115 SHELF 4

W. 115 D. 32 H. 198 cm

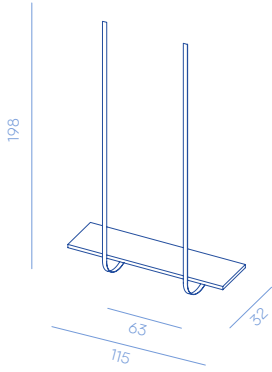

CODE / CODICE	IN	OUT	METAL FINISHES			EURO
DC650-400-G2	•		Stainless steel Acciaio inox	Orbitale DeLabré DeLabré orbitale	G2	1.750,00
DC650-400-G3	•		Brass Ottone	Orbitale DeLabré DeLabré orbitale	G3	1.870,00
DC650-400-G4	•		Copper Rame	Orbitale DeLabré DeLabré orbitale	G4	1.950,00

kg 9,5 kg

kg 17 kg

cm W. 262 D. 80 H. 55 cm

m³ 1,15 m³

N° 1

Excluding VAT
IVA esclusa

TALEA 115 SHELF 5

W. 115 D. 32 H. 233,5 cm

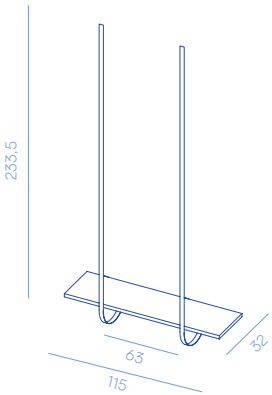

CODE / CODICE	IN	OUT	METAL FINISHES			EURO
DC650-500-G2	•		Stainless steel Acciaio inox	Orbitale DeLabré DeLabré orbitale	G2	1.870,00
DC650-500-G3	•		Brass Ottone	Orbitale DeLabré DeLabré orbitale	G3	1.960,00
DC650-500-G4	•		Copper Rame	Orbitale DeLabré DeLabré orbitale	G4	2.050,00

kg 10 kg

kg 18 kg

cm W. 262 D. 80 H. 60 cm

m³ 1,25 m³

N° 1

Excluding VAT
IVA esclusa

FIXING SYSTEM 115

W. 76 D. 7 H. 6 cm

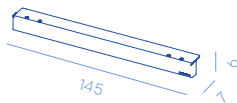

CODE / CODICE	IN	OUT	METAL FINISHES			EURO
DC650-600-E8	•		Iron Ferro	Noir Sablé Noir Sablé	E8	600,00
DC650-600-D8	•		Iron Ferro	RAL 9010 lacquered Laccato RAL 9010	D8	600,00

kg 4,5 kg

kg 0500 kg

cm W. 76,2 D. 3 H. 6 cm

m³ 0,10 m³

N° 1

Excluding VAT
IVA esclusa

TALEA 185 SHELF 1

W. 185 D. 32 H. 90,5 cm

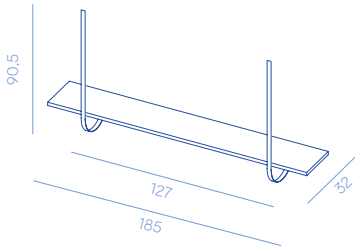

CODE / CODICE	IN	OUT	METAL FINISHES			EURO
DC651-100-G2	•		Stainless steel Acciaio inox	Orbitale DeLabré DeLabré orbitale	G2	1.600,00
DC651-100-G3	•		Brass Ottone	Orbitale DeLabré DeLabré orbitale	G3	1.670,00
DC651-100-G4	•		Copper Rame	Orbitale DeLabré DeLabré orbitale	G4	1.750,00

kg 11 kg
 kg 18 kg
 cm W. 262 D. 80 H. 40 cm
 m³ 0,85 m³
 N° 1
 Excluding VAT IVA esclusa

TALEA 185 SHELF 2

W. 185 D. 32 H. 126,5 cm

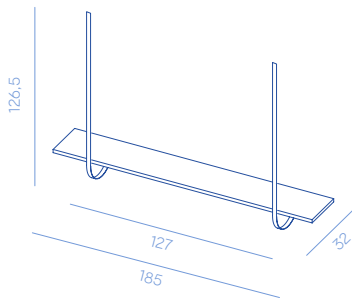

CODE / CODICE	IN	OUT	METAL FINISHES			EURO
DC651-200-G2	•		Stainless steel Acciaio inox	Orbitale DeLabré DeLabré orbitale	G2	1.630,00
DC651-200-G3	•		Brass Ottone	Orbitale DeLabré DeLabré orbitale	G3	1.750,00
DC651-200-G4	•		Copper Rame	Orbitale DeLabré DeLabré orbitale	G4	1.800,00

kg 12 kg
 kg 19 kg
 cm W. 262 D. 80 H. 45 cm
 m³ 0,95 m³
 N° 1
 Excluding VAT IVA esclusa

TALEA 185 SHELF 3

W. 185 D. 32 H. 162,5 cm

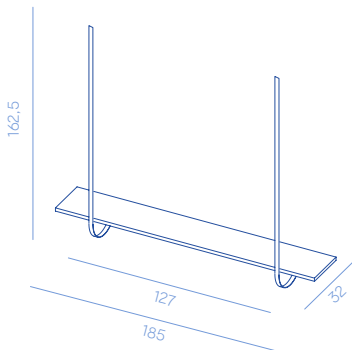

CODE / CODICE	IN	OUT	METAL FINISHES			EURO
DC651-300-G2	•		Stainless steel Acciaio inox	Orbitale DeLabré DeLabré orbitale	G2	1.700,00
DC651-300-G3	•		Brass Ottone	Orbitale DeLabré DeLabré orbitale	G3	1.780,00
DC651-300-G4	•		Copper Rame	Orbitale DeLabré DeLabré orbitale	G4	1.850,00

kg 12,5 kg
 kg 20 kg
 cm W. 262 D. 80 H. 50 cm
 m³ 1,05 m³
 N° 1
 Excluding VAT IVA esclusa

TALEA 185 SHELF 4

W. 185 D. 32 H. 198 cm

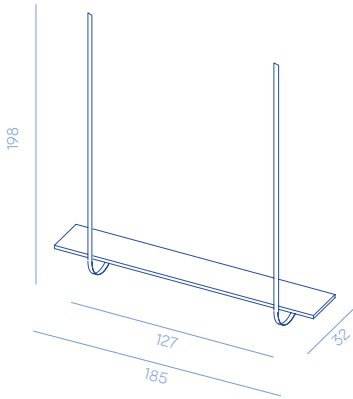

CODE / CODICE	IN	OUT	METAL FINISHES			EURO
DC651-400-G2	•		Stainless steel Acciaio inox	Orbitale DeLabré DeLabré orbitale	G2	1.780,00
DC651-400-G3	•		Brass Ottone	Orbitale DeLabré DeLabré orbitale	G3	1.850,00
DC651-400-G4	•		Copper Rame	Orbitale DeLabré DeLabré orbitale	G4	1.980,00

kg 0130 kg
 kg 21 kg
 cm W. 262 D. 80 H. 55 cm
 m³ 1,15 m³
 Nº 1
 Excluding VAT IVA esclusa

TALEA 185 SHELF 5

W. 185 D. 32 H. 233,5 cm

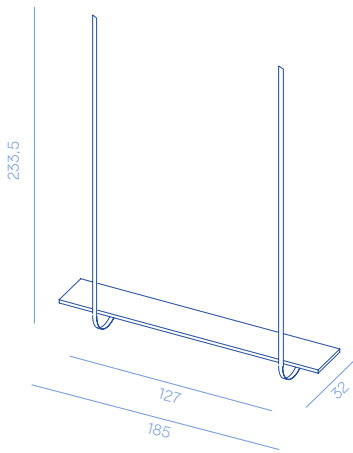

CODE / CODICE	IN	OUT	METAL FINISHES			EURO
DC651-500-G2	•		Stainless steel Acciaio inox	Orbitale DeLabré DeLabré orbitale	G2	1.820,00
DC651-500-G3	•		Brass Ottone	Orbitale DeLabré DeLabré orbitale	G3	1.960,00
DC651-500-G4	•		Copper Rame	Orbitale DeLabré DeLabré orbitale	G4	2.080,00

kg 13,5 kg
 kg 22 kg
 cm W. 262 D. 80 H. 60 cm
 m³ 1,25 m³
 Nº 1
 Excluding VAT IVA esclusa

FIXING SYSTEM 185

W. 145 D. 7 H. 6 cm

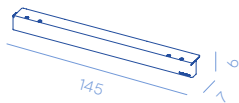

CODE / CODICE	IN	OUT	METAL FINISHES			EURO
DC651-600-E8	•		Iron Ferro	Noir Sablé Noir Sablé	E8	700,00
DC651-600-D8	•		Iron Ferro	RAL 9010 lacquered Laccato RAL 9010	D8	700,00

kg 8 kg
 kg 9 kg
 cm W. 145 D. 3 H. 6 cm
 m³ 0,10 m³
 Nº 1
 Excluding VAT IVA esclusa

TALEA 115 1+2+3+4+5+FS

W. 115 D. 32 H. 233,5 cm

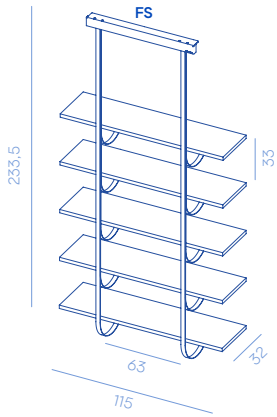

CODE / CODICE	IN	OUT	METAL FINISHES			EURO
	•		Stainless steel Acciaio inox	Orbitale DeLabré DeLabré orbitale	G2	8.960,00
	•		Brass Ottone	Orbitale DeLabré DeLabré orbitale	G3	9.490,00
	•		Copper Rame	Orbitale DeLabré DeLabré orbitale	G4	9.860,00

kg 48 kg

kg 65 kg

cm W. 262 D. 80 H. 60 cm

m³ 1,25 m³

N° 1

Excluding VAT
IVA esclusa

TALEA 115 1+2+4+5+FS

W. 115 D. 32 H. 233,5 cm

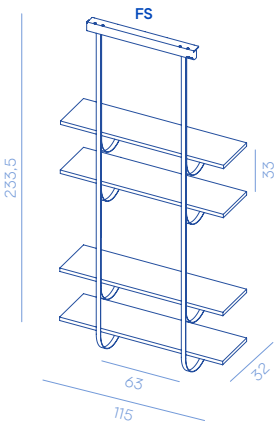

CODE / CODICE	IN	OUT	METAL FINISHES			EURO
	•		Stainless steel Acciaio inox	Orbitale DeLabré DeLabré orbitale	G2	7.260,00
	•		Brass Ottone	Orbitale DeLabré DeLabré orbitale	G3	7.690,00
	•		Copper Rame	Orbitale DeLabré DeLabré orbitale	G4	7.980,00

kg 39,5 kg

kg 60 kg

cm W. 262 D. 80 H. 55 cm

m³ 1,15 m³

N° 1

Excluding VAT
IVA esclusa

TALEA 185 1+2+3+4+5+FS

W. 185 D. 32 H. 233,5 cm

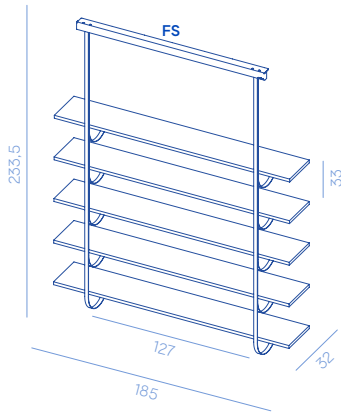

CODE / CODICE	IN	OUT	METAL FINISHES			EURO
			Stainless steel Acciaio inox	Orbitale DeLabré DeLabré orbitale	G2	9.230,00
			Brass Ottone	Orbitale DeLabré DeLabré orbitale	G3	9.710,00
			Copper Rame	Orbitale DeLabré DeLabré orbitale	G4	10.160,00

kg 70 kg

kg 80 kg

cm W. 262 D. 80 H. 60 cm

m³ 1,25 m³

N° 1

Excluding VAT
IVA esclusa

TALEA 185 1+2+3+4+FS

W. 185 D. 32 H. 198 cm

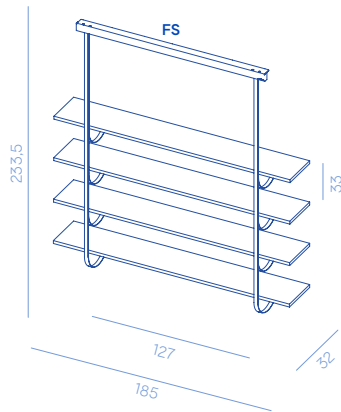

CODE / CODICE	IN	OUT	METAL FINISHES			EURO
			Stainless steel Acciaio inox	Orbitale DeLabré DeLabré orbitale	G2	7.410,00
			Brass Ottone	Orbitale DeLabré DeLabré orbitale	G3	7.750,00
			Copper Rame	Orbitale DeLabré DeLabré orbitale	G4	8.080,00

kg 57 kg

kg 72 kg

cm W. 262 D. 80 H. 55 cm

m³ 1,15 m³

N° 1

Excluding VAT
IVA esclusa

Consoles
Consolle

Convivium Console

DESIGN BY NIKITA BETTONI

Sculptural console entirely made of brass to be fixed on the wall.

Consolle scultura realizzata interamente in ottone da fissare a parete.

Convivium Console
DC529

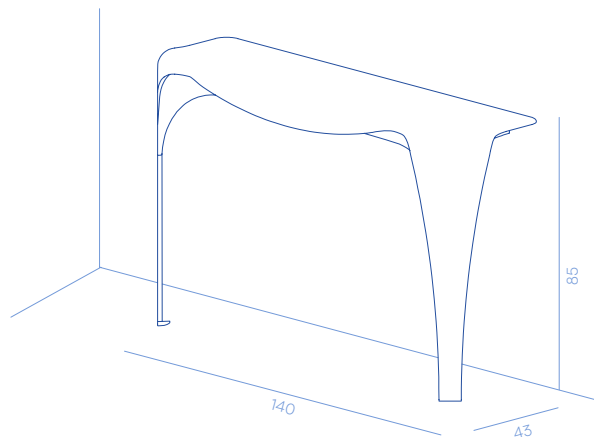

METAL FINISHES



G3



H3

PRODUCT SPECIFICATION

Assembly	Shipped assembled
Packaging	Wooden crate included TYPE A
Details	<ul style="list-style-type: none">- Console entirely made of brass- Load-bearing wall or reinforced plasterboard is required- Wall fixing system included, fixing screws excluded

ON REQUEST

Finishes	The product is available only in the finishes listed
Dimensions	<ul style="list-style-type: none">- The product can also be made in dimensions on request, subject to confirmation of feasibility by De Castelli- For custom made products please specify the dimensions, material and finishing- Price is on request

SPECIFICHE PRODOTTO

Assemblaggio	Spedito montato
Imballo	Imballo in cassa incluso TIPO A
Dettagli	<ul style="list-style-type: none">- Consolle interamente realizzata in ottone- È necessaria una parete portante o un cartongesso rinforzato- Sistema di fissaggio incluso, viteria per fissaggio esclusa

SU RICHIESTA

Finiture	Il prodotto è disponibile solo nelle finiture previste
Dimensioni	<ul style="list-style-type: none">- Il prodotto può essere realizzato anche in dimensioni su richiesta, previa conferma fattibilità da parte di De Castelli- In fase di richiesta specificare le dimensioni, il materiale e la finitura- Il prezzo è a preventivo

CONVIVIUM CONSOLE

W. 140 D. 43 H. 85 cm

CODE / CODICE	IN	OUT	METAL FINISHES			EURO
DC529-G3	•		Brass Ottone	Orbitale DeLabré DeLabré Orbitale	G3	9.900,00
DC529-H3	•		Brass Ottone	DeErosion DeErosion	H3	10.300,00

 88 kg

 100 kg

 W. 159 D. 104 H. 72 cm

 1,20 m³

 1

Excluding VAT
IVA esclusa

Existence Console

DESIGN BY MICHELE DE LUCCHI

Suspended console made entirely of metal to be fixed on the wall equipped with compartments of different sizes.

Consolle sospesa realizzata interamente in metallo da fissare a parete dotata di vani di diverse dimensioni.

Existence Console
DC675

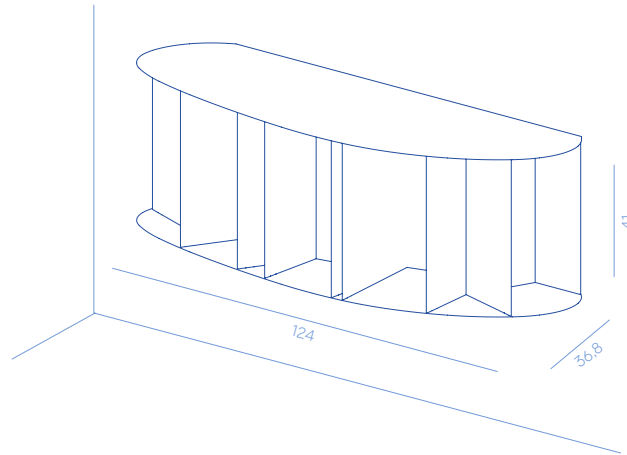

METAL FINISHES

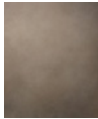

E5



G3

PRODUCT SPECIFICATION

Assembly	Shipped assembled
Packaging	Wooden cage included TYPE C
Details	<ul style="list-style-type: none">- Suspended console entirely made of metal equipped with compartments of different sizes- Load-bearing wall or reinforced plasterboard is required- Wall fixing system included, fixing screws excluded

ON REQUEST

Finishes	The product is available only in the finishes listed
Dimensions	<ul style="list-style-type: none">- The product can also be made in dimensions on request, subject to confirmation of feasibility by De Castelli- For custom made products please specify the dimensions, material and finishing- Price is on request

SPECIFICHE PRODOTTO

Assemblaggio	Spedito montato
Imballo	Imballo in gabbia di legno incluso TIPO C
Dettagli	<ul style="list-style-type: none">- Consolle sospesa interamente realizzata in metallo caratterizzata da scomparti di diverse dimensioni- È necessaria una parete portante o un cartongesso rinforzato- Sistema di fissaggio incluso, viteria per fissaggio esclusa

SU RICHIESTA

Finiture	Il prodotto è disponibile solo nelle finiture previste
Dimensioni	<ul style="list-style-type: none">- Il prodotto può essere realizzato anche in dimensioni su richiesta, previa conferma fattibilità da parte di De Castelli- In fase di richiesta specificare le dimensioni, il materiale e la finitura- Il prezzo è a preventivo

EXISTENCE CONSOLE

W. 124 D. 36,8 H. 41 cm

CODE / CODICE	IN	OUT	METAL FINISHES			EURO
DC675-E5	•		Stainless steel Acciaio inox	DeLabré B DeLabré B	E5	4.300,00
DC675-G3	•		Brass Ottone	Orbitale DeLabré DeLabré Orbitale	G3	6.400,00
DC675-G4	•		Rame Copper	Orbitale DeLabré DeLabré Orbitale	G4	7.500,00

 48 kg

 65 kg

 W. 143 D. 60 H. 67 cm

 0,60 m³

 1

Excluding VAT
IVA esclusa

Folio Console

DESIGN BY DRAW STUDIO

Console made entirely of metal to be fixed on the wall. It is characterized of 2 mm thick metal sheets spaced apart.

Consolle realizzata interamente in metallo da fissare a parete. Caratterizzato da lamiere di spessore 2 mm distanziate fra loro.

Folio Console
DC699

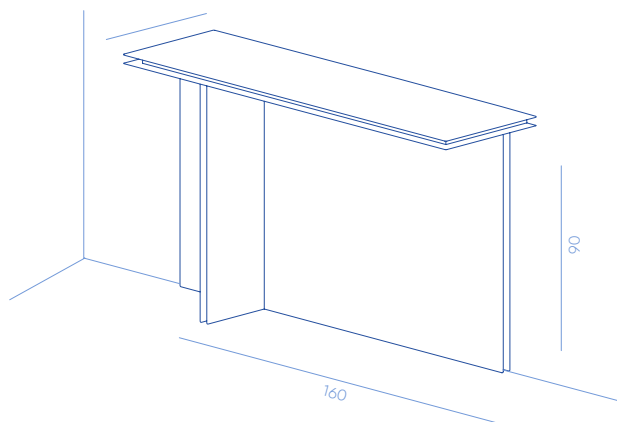

METAL FINISHES



M4

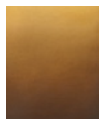

M6

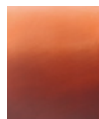

M5

PRODUCT SPECIFICATION

Assembly	Shipped assembled
Packaging	Wooden crate included TYPE A
Details	<ul style="list-style-type: none">- Console entirely made of metal- Load-bearing wall or reinforced plasterboard is required- Wall fixing system included, fixing screws excluded- Protective film included on top- Insert between sheets made of DeDeep G12 stainless steel

ON REQUEST

Finishes	<ul style="list-style-type: none">- The product can also be made upon request, subject to confirmation of feasibility by De Castelli- Price is on request
Dimensions	<ul style="list-style-type: none">- The product can also be made in dimensions on request, subject to confirmation of feasibility by De Castelli- For custom made products please specify the dimensions, material and finishing- Price is on request

SPECIFICHE PRODOTTO

Assemblaggio	Spedito montato
Imballo	Imballo in cassa incluso TIPO A
Dettagli	<ul style="list-style-type: none">- Consolle interamente realizzata in metallo- È necessaria una parete portante o un cartongesso rinforzato- Sistema di fissaggio incluso. Viteria per fissaggio esclusa- Film protettivo sul top incluso- Inserto tra le lastre in acciaio inox DeDeep G12

SU RICHIESTA

Finiture	<ul style="list-style-type: none">- Il prodotto può essere realizzato anche in finiture su richiesta, previa conferma fattibilità da parte di De Castelli- Il prezzo è a preventivo
Dimensioni	<ul style="list-style-type: none">- Il prodotto può essere realizzato anche in dimensioni su richiesta, previa conferma fattibilità da parte di De Castelli- In fase di richiesta specificare le dimensioni, il materiale e la finitura- Il prezzo è a preventivo

FOLIO CONSOLE

W. 160 D. 45 H. 90 cm

CODE / CODICE	IN	OUT	METAL FINISHES			EURO
DC699-M4	•		Stainless steel Acciaio inox	DeMarea DeMarea	M4	9.400,00
DC699-M6	•		Brass Ottone	DeMarea DeMarea	M6	12.000,00
DC699-M5	•		Copper Rame	DeMarea DeMarea	M5	14.000,00

 100 kg

 130 kg

 W. 180 D. 110 H. 77 cm

 1,52 m³

 1

Excluding VAT
IVA esclusa

Sinestesia Console

DESIGN BY TIPSTUDIO

Free-standing console entirely made of 3 mm thick metal sheets. The top is characterized by leaf shape, the base consists on 4 curved metal sheets. The console is double-sided: the convex side is characterized by a DeErosion H11 finishing, the concave side by a brushed finishing.

Consolle free-standing realizzata interamente in lastre di metallo di 3 mm di spessore. Il top è caratterizzato da una forma a foglia, la base consiste in 4 lastre curvate. La consolle è bifacciale: il lato convesso è caratterizzato dalla finitura DeErosion H11, il lato concavo dalla finitura spazzolata.

Sinestesia
DC693

Front / Fronte

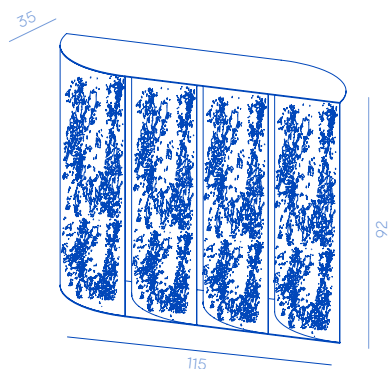

Back / Retro

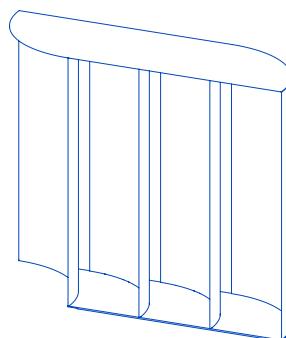

METAL FINISHES

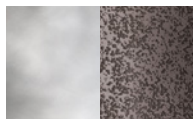

IX-H11



OT-H11

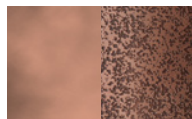

RA-H11

PRODUCT SPECIFICATION

Assembly	Shipped assembled
Packaging	Wooden cage included TYPE C
Details	<ul style="list-style-type: none"> – Self-standing console entirely made of metal – It features the convex side in DeErosion H11, the concave side in brushed finishing – It can be positioned by choosing the visible side as desired

SPECIFICHE PRODOTTO

Assemblaggio	Spedito montato
Imballo	Imballo in gabbia di legno incluso TIPO C
Dettagli	<ul style="list-style-type: none"> – Consolle self-standing realizzata interamente in metallo – Presenta il lato convesso in finitura DeErosion H11, il lato concavo in finitura spazzolata, – Può essere posizionata a piacere scegliendo il lato visibile

ON REQUEST

Finishes	<ul style="list-style-type: none"> – The product can also be made in finishes upon request, subject to confirmation of feasibility by De Castelli – Price is on request
Dimensions	<ul style="list-style-type: none"> – The product can also be made in dimensions on request, subject to confirmation of feasibility by De Castelli. – For custom made products please specify the dimensions, material and finishing – Price is on request

SU RICHIESTA

Finiture	<ul style="list-style-type: none"> – Il prodotto può essere realizzato anche in finiture su richiesta, previa conferma fattibilità da parte di De Castelli – Il prezzo è a preventivo
Dimensioni	<ul style="list-style-type: none"> – Il prodotto può essere realizzato anche in dimensioni su richiesta, previa conferma fattibilità da parte di De Castelli – In fase di richiesta specificare le dimensioni, il materiale e la finitura – Il prezzo è a preventivo

SINESTESIA CONSOLE

W. 115 D. 35 H. 92 cm

CODE / CODICE	IN	OUT	METAL FINISHES			EURO
DC693-IX-H11	•		Stainless steel Acciaio inox	DeErosion DeErosion	H11	8.900,00
DC693-OT-H11	•		Brass Ottone	DeErosion DeErosion	H11	10.800,00
DC693-RA-H11	•		Copper Rame	DeErosion DeErosion	H11	13.000,00

 73 kg

 93 kg

 W. 135 D. 69 H. 124 cm

 1,15 m³

 1

Excluding VAT
IVA esclusa

Tables
Tavoli

Baia

DESIGN BY ZANELLATO/BORTOTTO

Sculptural table characterized by a top with organic shapes and two cylindrical legs base.

Tavolo scultoreo caratterizzato da un piano dalle forme organiche e base a due gambe cilindriche.

Baia
DC667

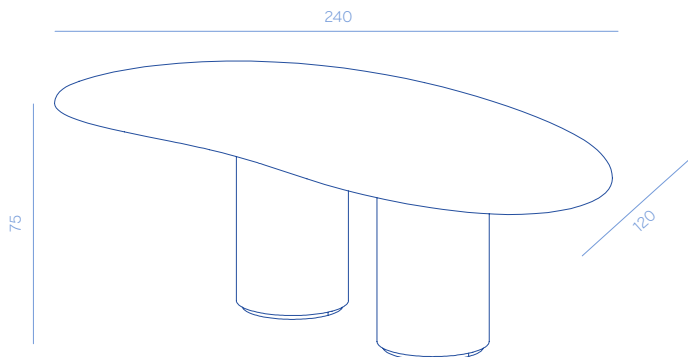

METAL FINISHES

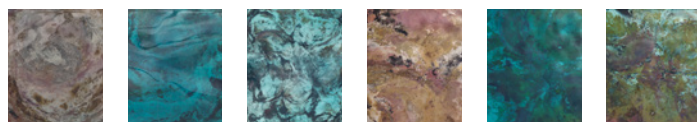

N1

N2

N4

N10

N20

N40

PRODUCT SPECIFICATION

Legs

Brushed copper M10
DeLabré B stainless steel E5
Matt lacquered stainless steel M15

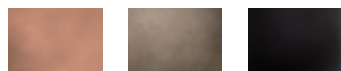

M10

E5

M15

Assembly

Shipped disassembled

Packaging

Wooden crate included [TYPE D](#)

Details

- Sculptural table with two cylindrical legs
- Legs and top finishes can be combined as desired

SPECIFICHE PRODOTTO

Gambe

Rame spazzolato M10
Acciaio inox DeLabré B E5
Acciaio inox laccato opaco M15

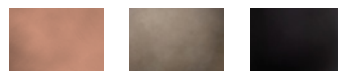

M10

E5

M15

Assemblaggio

Spedito smontato

Imballo

Imballo in cassa incluso [TIPO D](#)

Dettagli

- Tavolo scultoreo con due gambe cilindriche
- Le finiture delle gambe e del top sono combinabili a piacere

ON REQUEST

Finishes

The product is available only in the finishes listed

Dimensions

- The product can also be made in dimensions on request, subject to confirmation of feasibility by De Castelli
- For custom made products please specify the dimensions, material and finishing
- Price is on request

SU RICHIESTA

Finiture

Il prodotto è disponibile solo nelle finiture previste a listino.

Dimensioni

- Il prodotto può essere realizzato anche in dimensioni su richiesta, previa conferma fattibilità da parte di De Castelli
- In fase di richiesta specificare le dimensioni, il materiale e la finitura
- Il prezzo è a preventivo

CODE / CODICE	IN	OUT	METAL FINISHES	EURO
---------------	----	-----	----------------	------

W. 240 D. 120 H. 75 cm

Legs in matt black lacquered stainless steel M15 / Gambe in acciaio inox laccato nero opaco M15

DC667-N1-M15	•		Copper Rame	DeNuance Forest DeNuance Foresta	N1	14.200,00
DC667-N2-M15	•		Copper Rame	DeNuance Ocean DeNuance Oceano	N2	14.200,00
DC667-N4-M15	•		Copper Rame	DeNuance Lagoon DeNuance Laguna	N4	14.200,00
DC667-N10-M15	•		Copper Rame	Matt DeNuance Forest DeNuance Foresta opaco	N10	14.200,00
DC667-N20-M15	•		Copper Rame	Matt DeNuance Ocean DeNuance Oceano opaco	N20	14.200,00
DC667-N40-M15	•		Copper Rame	Matt DeNuance Lagoon DeNuance Laguna opaco	N40	14.200,00

Legs in DeLabré stainless steel E5 / Gambe in acciaio inox DeLabré E5

DC667-N1-E5	•		Copper Rame	DeNuance Forest DeNuance Foresta	N1	14.700,00
DC667-N2-E5	•		Copper Rame	DeNuance Ocean DeNuance Oceano	N2	14.700,00
DC667-N4-E5	•		Copper Rame	DeNuance Lagoon DeNuance Laguna	N4	14.700,00
DC667-N10-E5	•		Copper Rame	Matt DeNuance Forest DeNuance Foresta opaco	N10	14.700,00
DC667-N20-E5	•		Copper Rame	Matt DeNuance Ocean DeNuance Oceano opaco	N20	14.700,00
DC667-N40-E5	•		Copper Rame	Matt DeNuance Lagoon DeNuance Laguna opaco	N40	14.700,00

Legs in brushed copper M10 / Gambe in rame spazzolato M10

DC667-N1-M10	•		Copper Rame	DeNuance Forest DeNuance Foresta	N1	15.700,00
DC667-N2-M10	•		Copper Rame	DeNuance Ocean DeNuance Oceano	N2	15.700,00
DC667-N4-M10	•		Copper Rame	DeNuance Lagoon DeNuance Laguna	N4	15.700,00
DC667-N10-M10	•		Copper Rame	Matt DeNuance Forest DeNuance Foresta opaco	N10	15.700,00
DC667-N20-M10	•		Copper Rame	Matt DeNuance Ocean DeNuance Oceano opaco	N20	15.700,00
DC667-N40-M10	•		Copper Rame	Matt DeNuance Lagoon DeNuance Laguna opaco	N40	15.700,00

 145 kg 160 kg W. 250 D. 80 H. 137 cm 2,74 m² 1Excluding VAT
IVA esclusa

Burraco Table & Pouf

DESIGN BY ZANELLATO/BORTOTTO

Round game table with copper top characterized by decorations with eroded game seeds. Four retractable cup holders. Coordinated pouf in green velvet.

Tavolo da gioco tondo con piano in rame caratterizzato da decori con semi da gioco erosi. Quattro portabicchieri a scomparsa. Pouf coordinato in velluto verde.

Burraco Table
DC646

Closed / Chiuso

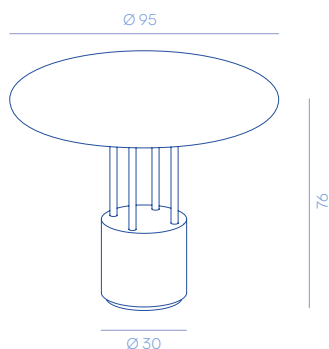

Open / Aperto

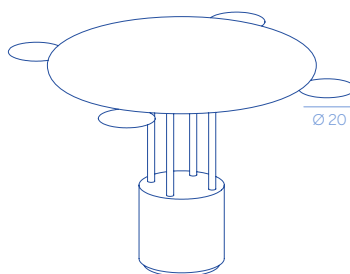

Burraco Pouf
DC647

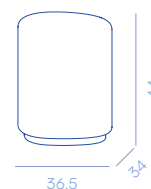

METAL FINISHES



M10

PRODUCT SPECIFICATION

Assembly	Shipped assembled
Packaging DC646 DC647	Wooden crate included TYPE A Carton box TYPE E
Details DC646	<ul style="list-style-type: none"> – Round game table with a copper top characterized by game seeds decoration in DeErosion technique – Equipped with four retractable cup holders – Green velvet – Minimum order 4 pieces
DC647	

SPECIFICHE PRODOTTO

Assemblaggio	Spedito montato
Imballo DC646 DC647	Imballo in cassa incluso TIPO A Imballo in scatola di cartone TIPO E
Dettagli DC646	<ul style="list-style-type: none"> – Tavolo da gioco tondo con top in rame caratterizzato da decori in DeErosion – Attrezzato con quattro portabicchieri a scomparsa – Velluto verde – Ordine minimo previsto di 4 pezzi
DC647	

ON REQUEST

Finishes	The product is available only in the finishes listed
Dimensions	The product is available only in the dimensions listed

SU RICHIESTA

Finiture	Il prodotto è disponibile solo nelle finiture previste a listino
Dimensioni	Il prodotto è disponibile solo nelle dimensioni previste a listino

BURRACO TABLE

W. 95 D. 95 H. 76 cm

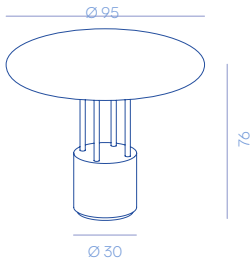

CODE / CODICE	IN	OUT	METAL FINISHES / MATERIALI E FINITURE			EURO
DC646-M10	•		Copper Rame	Brushed Spazzolato	M10	8.700,00

kg 90 kg
kg 125 kg
cm < cm >
m³ 1,40 m³
N° 1
Excluding VAT IVA esclusa

BURRACO POUF

W. 36,5 D. 34 H. 44 cm

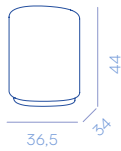

CODE / CODICE	IN	OUT	METAL FINISHES / MATERIALI E FINITURE			EURO
DC647-M10	•		Copper Rame	Brushed Spazzolato	M10	2.000,00

kg 5 kg
kg 10 kg
cm < cm >
m³ 0,18 m³
N° 1
Excluding VAT IVA esclusa

Convivium Table

DESIGN BY NIKITA BETTONI

Sculptural table entirely made of brass characterized by a top in DeErosion finishing.

Tavolo scultura interamente realizzato in ottone e caratterizzato da un top in finitura DeErosion.

Convivium 220
DC534

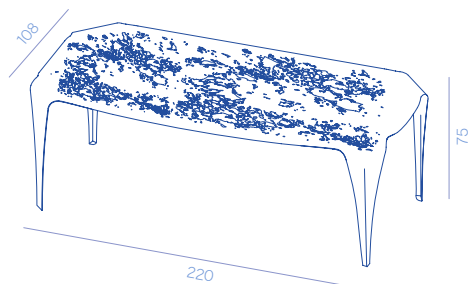

Convivium 280
DC530

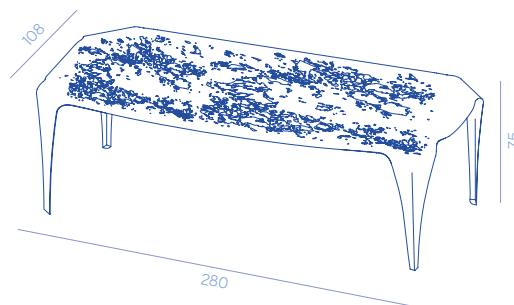

METAL FINISHES



H3

PRODUCT SPECIFICATION

Assembly	Shipped assembled
Packaging	Wooden crate included TYPE A
Details	– Sculptural table entirely made of brass

ON REQUEST

Finishes	The product is available only in the finishes listed
Dimensions	– The product can also be custom made in sizes on request up to a maximum of 3 m in length and 1.40 m in width, subject to confirmation of feasibility by De Castelli – For custom made products please specify the dimensions, material and finishing – Price is on request

SPECIFICHE PRODOTTO

Assemblaggio	Spedito montato
Imballo	Imballo in cassa incluso TIPO A
Dettagli	– Tavolo scultoreo interamente realizzato in ottone

SU RICHIESTA

Finiture	Il prodotto è disponibile solo nelle finiture previste a listino
Dimensioni	– Il prodotto può essere realizzato anche in dimensioni su richiesta fino ad un massimo di 3 metri in lunghezza e 1,40 metri in larghezza, previa conferma fattibilità da parte di De Castelli – In fase di richiesta specificare le dimensioni e la finitura desiderate – Il prezzo è a preventivo

CONVIVIAM TABLE

W. 220 D. 108 H. 75 cm

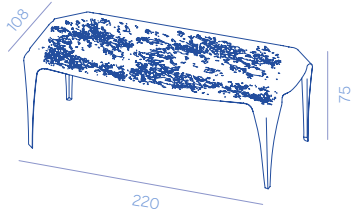

CODE / CODICE	IN	OUT	METAL FINISHES			EURO
DC534-H3	•		Brass Ottone	DeErosion DeErosion	H3	26.500,00

kg 145 kg
 kg 165 kg
 cm W. 239. 124 H. 112 cm
 m² 3,20 m²
 N° 1
 Excluding VAT
IVA esclusa

CONVIVIAM TABLE

W. 280 D. 108 H. 75 cm

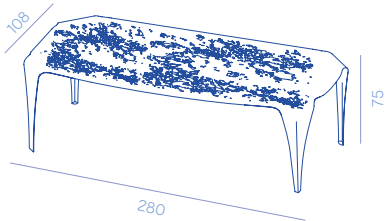

CODE / CODICE	IN	OUT	METAL FINISHES			EURO
DC530-H3	•		Brass Ottone	DeErosion DeErosion	H3	31.500,00

kg 175 kg
 kg 200 kg
 cm W. 300 D. 124 H. 112 cm
 m² 4,20 m²
 N° 1
 Excluding VAT
IVA esclusa

Coste Table

DESIGN BY LUCA PEVERE

Large round table with top clad in stainless steel. The central truncated cone base consists of the juxtaposition of a folded metal module.

Grande tavolo rotondo con top in acciaio inox DeDeep con basamento centrale di forma tronco-conica composto dalla giustapposizione di un modulo piegato in metallo.

Coste 120
DC678

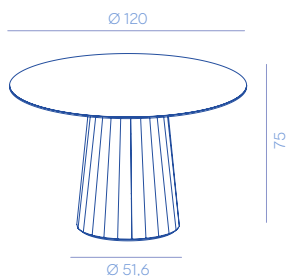

Coste 160
DC677

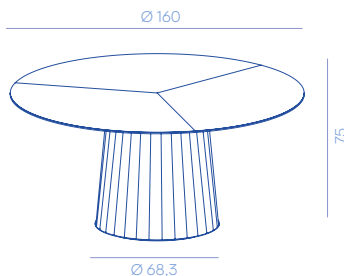

Coste 180
DC676

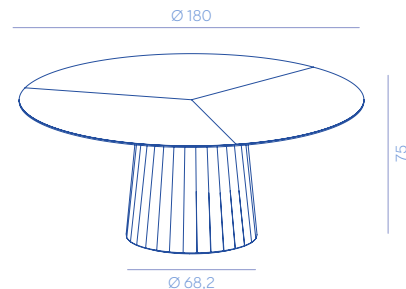

METAL FINISHES



M11

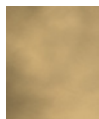

M9



M10

PRODUCT SPECIFICATION

Top	DeDeep stainless steel G12 
Assembly	Shipped disassembled
Packaging	Wooden crate included TYPE D
Details	<ul style="list-style-type: none"> – Top made in matt lacquered RAL 9004 MDF clad in stainless steel – Protective film included on top – Top made of one metal sheet
DC678 DC677/DC676	<ul style="list-style-type: none"> – Top made of three metal sheets

SPECIFICHE PRODOTTO

Top	Acciaio inox DeDeep G12 
Assemblaggio	Spedito smontato
Imballo	Imballo in cassa incluso TIPO D
Dettagli	<ul style="list-style-type: none"> – Top in MDF laccato opaco RAL 9004 rivestito in acciaio inox – Film protettivo sul top incluso – Top realizzato da una unica lastra
DC678 DC677/DC676	<ul style="list-style-type: none"> – Top realizzato da tre lastre

ON REQUEST

Finishes	The product is available only in the finishes listed
Dimensions	The product is available only in the dimensions listed

SU RICHIESTA

Finiture	Il prodotto è disponibile solo nelle finiture previste a listino
Dimensioni	Il prodotto è disponibile solo nelle dimensioni previste a listino

COSTE 120

W. 120 D. 120 H. 75 cm

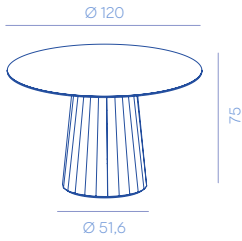

CODE / CODICE	IN	OUT	METAL FINISHES			EURO
DC678-M11	•		Stainless steel Acciaio inox	Brushed Spazzolato	M11	12.700,00
DC678-M9	•		Brass Ottone	Brushed Spazzolato	M9	13.500,00
DC678-M10	•		Copper Rame	Brushed Spazzolato	M10	14.700,00

kg 60 kg
 kg 80 kg
 cm W. 130 D. 120 H. 148 cm
 m³ 2,30 m³
 N° 1
 Excluding VAT
IVA esclusa

COSTE 160

W. 160 D. 160 H. 75 cm

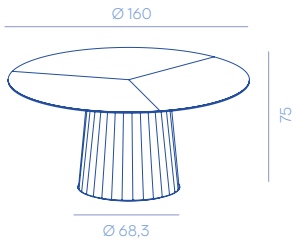

CODE / CODICE	IN	OUT	METAL FINISHES			EURO
DC677-M11	•		Stainless steel Acciaio inox	Brushed Spazzolato	M11	15.900,00
DC677-M9	•		Brass Ottone	Brushed Spazzolato	M9	16.800,00
DC677-M10	•		Copper Rame	Brushed Spazzolato	M10	17.900,00

kg 106 kg
 kg 170 kg
 cm W. 170 D. 120 H. 188 cm
 m³ 3,83 m³
 N° 1
 Excluding VAT
IVA esclusa

COSTE 180

W. 180 D. 180 H. 75 cm

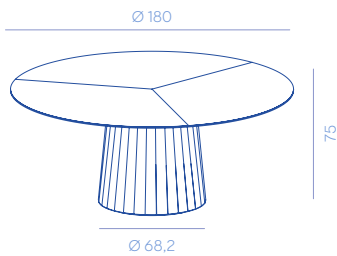

CODE / CODICE	IN	OUT	METAL FINISHES			EURO
DC676-M11	•		Stainless steel Acciaio inox	Brushed Spazzolato	M11	17.700,00
DC676-M9	•		Brass Ottone	Brushed Spazzolato	M9	18.900,00
DC676-M10	•		Copper Rame	Brushed Spazzolato	M10	19.900,00

kg 120 kg
 kg 190 kg
 cm W. 200 D. 120 H. 190 cm
 m³ 4,56 m³
 N° 1
 Excluding VAT
IVA esclusa

Folio Table

DESIGN BY DRAW STUDIO

Table made of 2 mm thick metal sheets spaced apart by an internal structure.

Tavolo composto da 2 lastre di metallo in spessore 2 mm distanziati tra loro da una struttura interna.

Folio Table
DC698

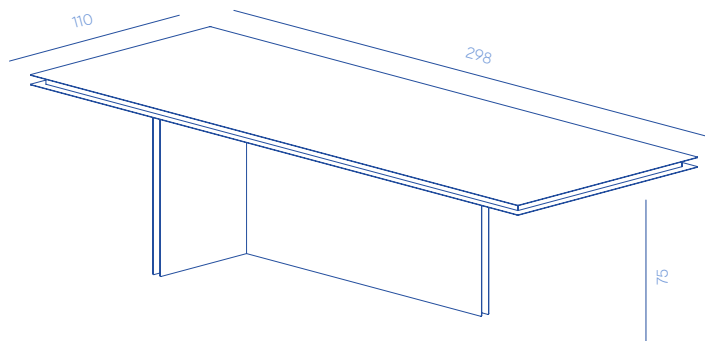

METAL FINISHES

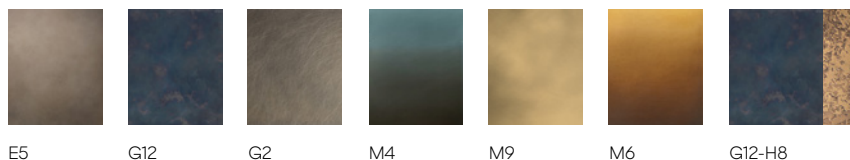

PRODUCT SPECIFICATION

Assembly	Shipped disassembled
Packaging	Wooden crate included TYPE B
Details	<ul style="list-style-type: none">- Table entirely made of 2 mm thick metal sheets spaced apart- Protective film included on top- Insert between sheets made of DeDeep G12 stainless steel, except for DC698-G12-H8 which is made of DeErosion H8 on brass

SPECIFICHE PRODOTTO

Assemblaggio	Spedito smontato
Imballo	Imballo in cassa incluso TIPO B
Dettagli	<ul style="list-style-type: none">- Tavolo composto da due lastre di metallo in spessore 2 mm distanziate fra loro- Film protettivo sul top incluso- Inserto tra lamiere in acciaio inossidabile DeDeep G12, ad eccezione di DC698-G12-H8 che è realizzato in DeErosion H8 su ottone

ON REQUEST

Finishes	<ul style="list-style-type: none">- The product can also be made upon request, subject to confirmation of feasibility by De Castelli- Price is on request
Dimensions	<ul style="list-style-type: none">- The product can also be custom made in sizes on request up to a maximum of 3 m in length and 1.40 m in width, subject to confirmation of feasibility by De Castelli- For custom made products please specify the dimensions, material and finishing- Price is on request

SU RICHIESTA

Finiture	<ul style="list-style-type: none">- Il prodotto può essere realizzato anche in finiture su richiesta, previa conferma fattibilità da parte di De Castelli- Il prezzo è a preventivo
Dimensioni	<ul style="list-style-type: none">- Il prodotto può essere realizzato anche in dimensioni su richiesta, previa conferma fattibilità da parte di De Castelli- In fase di richiesta specificare le dimensioni, il materiale e la finitura- Il prezzo è a preventivo

FOLIO TABLE

W. 298 D. 110 H. 75 cm

CODE / CODICE	IN	OUT	METAL FINISHES			EURO
DC698-E5	•		Stainless steel Acciaio inox	DeLabré B DeLabré B	E5	21.000,00
DC698-G2	•		Stainless steel Acciaio inox	Orbitale DeLabré DeLabré orbitale	G2	22.000,00
DC698-G12	•		Stainless steel Acciaio inox	DeDeep DeDeep	G12	23.500,00
DC698-M4	•		Stainless steel Acciaio inox	DeMarea DeMarea	M4	23.700,00
DC698-G12-H8	•		Stainless steel Acciaio inox	DeDeep DeDeep	G12-H8	24.500,00
DC698-M9	•		Brass Ottone	Brushed Spazzolato	M9	26.000,00
DC698-M6	•		Brass Ottone	DeMarea DeMarea	M6	26.500,00

 238 kg

 290 kg

 W. 320 D. 80 H. 124 cm

 3,17 m³

 1

Excluding VAT
IVA esclusa

Folio Table round

DESIGN BY DRAW STUDIO

Round table made of 2 mm thick metal sheets spaced apart by an internal structure.

Tavolo rotondo composto da 2 lastre di metallo in spessore 2 mm distanziate tra loro da una struttura interna.

Folio Table round
DC700

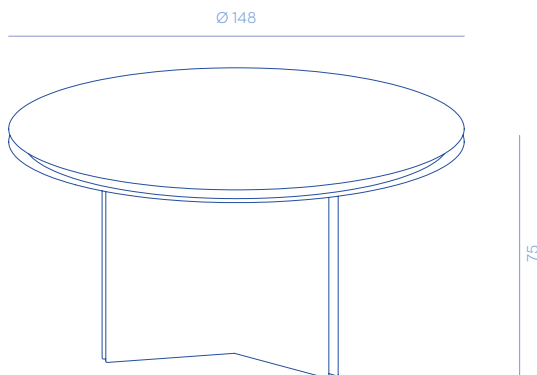

METAL FINISHES

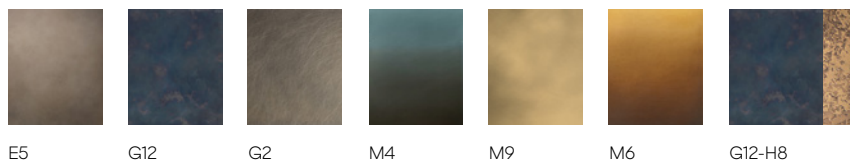

PRODUCT SPECIFICATION

Assembly	Shipped disassembled
Packaging	Wooden crate included TYPE A+B
Details	<ul style="list-style-type: none">- Table entirely made of 2 mm thick metal sheets spaced apart- Protective film included on top- Insert between sheets made of DeDeep G12 stainless steel, except for DC698-G12-H8 which is made of DeErosion H8 on brass

ON REQUEST

Finishes	<ul style="list-style-type: none">- The product can also be made upon request, subject to confirmation of feasibility by De Castelli- Price is on request
Dimensions	<ul style="list-style-type: none">- The product can also be custom made in sizes on request up to a maximum of 3 m in length and 1.40 m in width, subject to confirmation of feasibility by De Castelli- For custom made products please specify the dimensions, material and finishing- Price is on request

SPECIFICHE PRODOTTO

Assemblaggio	Spedito smontato
Imballo	Imballo in cassa incluso TIPO A+B
Dettagli	<ul style="list-style-type: none">- Tavolo composto da due lastre di metallo in spessore 2 mm distanziate fra loro- Film protettivo sul top incluso- Inserto tra lamiere in acciaio inossidabile DeDeep G12, ad eccezione di DC698-G12-H8 che è realizzato in DeErosion H8 su ottone

SU RICHIESTA

Finiture	<ul style="list-style-type: none">- Il prodotto può essere realizzato anche in finiture su richiesta, previa conferma fattibilità da parte di De Castelli- Il prezzo è a preventivo
Dimensioni	<ul style="list-style-type: none">- Il prodotto può essere realizzato anche in dimensioni su richiesta, previa conferma fattibilità da parte di De Castelli- In fase di richiesta specificare le dimensioni, il materiale e la finitura- Il prezzo è a preventivo

FOLIO TABLE ROUND

W. 148 D. 148 H. 75 cm

CODE / CODICE	IN	OUT	METAL FINISHES			EURO
DC698-E5	•		Stainless steel Acciaio inox	DeLabré B DeLabré B	E5	13.000,00
DC698-G2	•		Stainless steel Acciaio inox	Orbitale DeLabré DeLabré orbitale	G2	13.500,00
DC698-G12	•		Stainless steel Acciaio inox	DeDeep DeDeep	G12	14.500,00
DC698-M4	•		Stainless steel Acciaio inox	DeMarea DeMarea	M4	15.500,00
DC698-G12-H8	•		Stainless steel Acciaio inox	DeDeep DeDeep	G12-H8	15.800,00
DC698-M9	•		Brass Ottone	Brushed Spazzolato	M9	17.300,00
DC698-M6	•		Brass Ottone	DeMarea DeMarea	M6	18.000,00

 160 kg

 200 kg

 A) W. 99 D. 89 H. 102 cm
B) W. 167 D. 80 H. 176 cm

 A) 0,9 m²
B) 2,35 m²

 2

Excluding VAT
IVA esclusa

Plateaux of Mirror

DESIGN BY ELISA OSSINO

Sculpture table made of 3 elements only: a 10 mm thickness rectangular top made of aluminum and 2 huge semi-cylindrical bases in stainless steel.

Tavolo scultura composto di soli tre elementi: un top rettangolare in alluminio spessore 10 mm e due grandi semi-cilindri in acciaio inox che ne costituiscono la base.

Plateaux of mirror 250
DC672

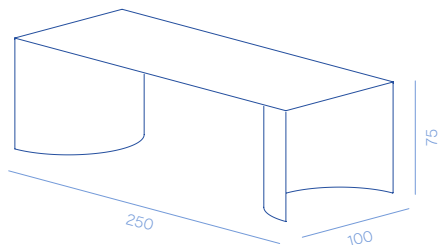

Plateaux of mirror 300
DC670

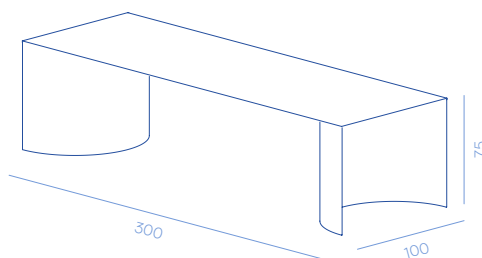

METAL FINISHES

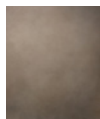

E5

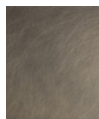

G2

PRODUCT SPECIFICATION

Assembly	Shipped disassembled
Packaging	Wooden crate included TYPE D
Details	<ul style="list-style-type: none">- Table entirely made of metal- Protective film included on top

ON REQUEST

Finishes	The product is available only in the finishes listed
Dimensions	<ul style="list-style-type: none">- The product can also be custom made in sizes on request up to a maximum of 3 m in length and 1.40 m in width, subject to confirmation of feasibility by De Castelli- For custom made products please specify the dimensions, material and finishing- Price is on request

SPECIFICHE PRODOTTO

Assemblaggio	Spedito smontato
Imballo	Imballo in cassa incluso TIPO D
Dettagli	<ul style="list-style-type: none">- Tavolo interamente realizzato in metallo- Film protettivo sul top incluso

SU RICHIESTA

Finiture	Il prodotto è disponibile solo nelle finiture previste a listino
Dimensioni	<ul style="list-style-type: none">- Il prodotto può essere realizzato anche in dimensioni su richiesta, previa conferma fattibilità da parte di De Castelli- In fase di richiesta specificare le dimensioni, il materiale e la finitura- Il prezzo è a preventivo

PLATEAUX OF MIRROR 250

W. 250 D. 100 H. 75 cm

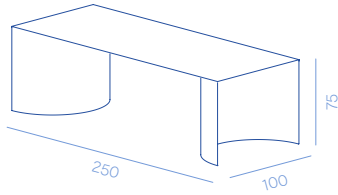

CODE / CODICE	IN	OUT	METAL FINISHES			EURO
DC672-E5	•		Stainless steel Acciaio inox	DeLabré B DeLabré B	E5	19.500,00
DC672-G2	•		Stainless steel Acciaio inox	Orbitale DeLabré DeLabré Orbitale	G2	20.500,00

kg 163 kg
 kg 260 kg
 cm W. 270 D. 105 H. 123 cm
 m³ 3,72 m³
 N° 1
 Excluding VAT
IVA esclusa

PLATEAUX OF MIRROR 300

W. 300 D. 100 H. 75 cm

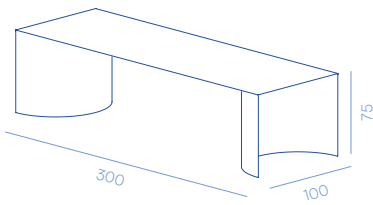

CODE / CODICE	IN	OUT	METAL FINISHES			EURO
DC670-E5	•		Stainless steel Acciaio inox	DeLabré B DeLabré B	E5	21.000,00
DC670-G2	•		Stainless steel Acciaio inox	Orbitale DeLabré DeLabré Orbitale	G2	22.000,00

kg 180 kg
 kg 300 kg
 cm W. 320 D. 105 H. 132 cm
 m³ 4,42 m³
 N° 1
 Excluding VAT
IVA esclusa

Roma

DESIGN BY MINELLI FOSSATI

Round metal table characterized by a curved base and metal feet in contrast with the structure.

Tavolo tondo in metallo caratterizzato da fondo bombato e puntali in metallo a contrasto con la struttura.

Roma 137
DC609

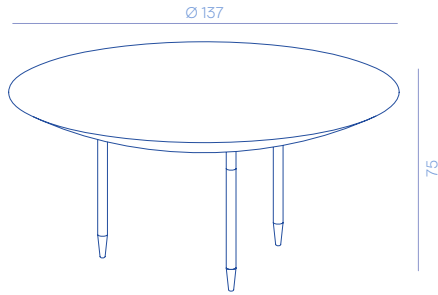

Roma 160
DC610

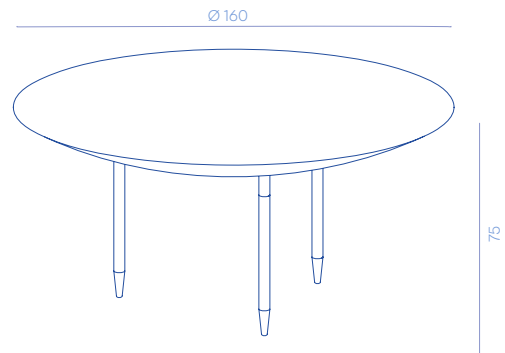

METAL FINISHES



M0

PRODUCT SPECIFICATION

Feet	Brushed brass M9 Brushed copper M10
	
Assembly	Shipped disassembled
Packaging	Wooden cage included TYPE D
Details	- Sculptural table entirely made of metal - Feet made of brass or copper

ON REQUEST

Finishes	The product is available only in the finishes listed
Dimensions	The product is available only in the dimensions listed

SPECIFICHE PRODOTTO

Gambe	Ottone spazzolato M9 Rame spazzolato M10
	
Assemblaggio	Spedito Smontato
Imballo	Imballo in cassa incluso TIPO D
Dettagli	- Tavolo scultoreo realizzato interamente in metallo - Piedini disponibili in ottone o in rame

SU RICHIESTA

Finiture	Il prodotto è disponibile solo nelle finiture previste a listino
Dimensioni	Il prodotto è disponibile solo nelle dimensioni previste a listino

ROMA 137

W. 137 D. 137 H. 75 cm

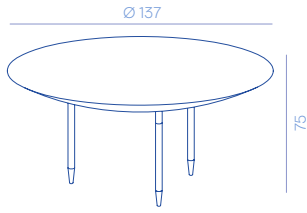

CODE / CODICE	IN	OUT	METAL FINISHES			EURO
DC609-OT	•		Stainless steel Acciaio inox	DeOpale DeOpale	M0	9.800,00
DC609-RA	•		Stainless steel Acciaio inox	DeOpale DeOpale	M0	10.000,00

kg 100 kg
kg 130 kg
cm < cm >
m³ 2,40 m³
N° 1
Excluding VAT IVA esclusa

ROMA 160

W. 160 D. 160 H. 75 cm

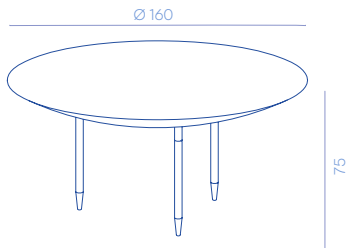

CODE / CODICE	IN	OUT	METAL FINISHES			EURO
DC610-OT	•		Stainless steel Acciaio inox	DeOpale DeOpale	M0	11.800,00
DC610-RA	•		Stainless steel Acciaio inox	DeOpale DeOpale	M0	12.000,00

kg 130 kg
kg 160 kg
cm < cm >
m³ 2,70 m³
N° 1
Excluding VAT IVA esclusa

Vela Table

DESIGN BY R&D DE CASTELLI

Sculptural table characterized by an oval top made of Venetian-style terrace white marble with brass inserts and a waves shaped base entirely made of brass.

Tavolo scultura caratterizzato da un top ovale in seminato veneziano di marmo bianco con inserti in ottone e una base ondulata interamente realizzata in ottone.

Vela
DC669

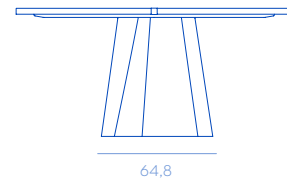
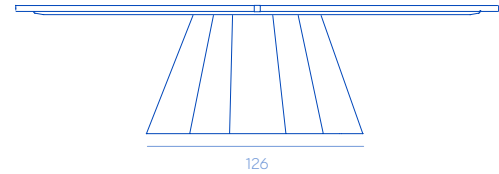
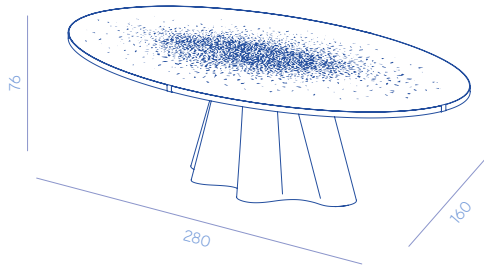

METAL FINISHES

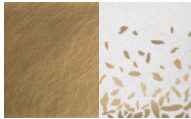

G3

PRODUCT SPECIFICATION

Assembly	Shipped disassembled
Packaging	Wooden cage included TYPE A+B
Details	– Sculptural table with handmade top in Venetian-style terrace with brass inserts

SPECIFICHE PRODOTTO

Assemblaggio	Spedito smontato
Imballo	Imballo in cassa incluso TIPO A+B
Dettagli	– Tavolo scultoreo con il top in seminato veneziano con inserti in ottone

ON REQUEST

Finishes	The product is available only in the finishes listed
Dimensions	– The product can also be custom made in sizes on request up to a maximum of 3 m in length and 1.40 m in width, subject to confirmation of feasibility by De Castelli – For custom made products please specify the dimensions, material and finishing – Price is on request

SU RICHIESTA

Finiture	The product is available only in the finishes listed
Dimensioni	– Il prodotto può essere realizzato anche in dimensioni su richiesta, previa conferma fattibilità da parte di De Castelli – In fase di richiesta specificare le dimensioni, il materiale e la finitura – Il prezzo è a preventivo

VELA TABLE

W. 280 D. 160 H. 76 cm

CODE / CODICE	IN	OUT	METAL FINISHES			EURO
DC669-G3	•		Brass Ottone	Orbitale DeLabré DeLabré Orbitale	G3	35.000,00

 275 kg

 340 kg

 A) W. 144 D. 84 H. 102 cm
B) W. 320 D. 80 H. 200 cm

 A) 5,3 m³
B) 5,1 m³

 2

Excluding VAT
IVA esclusa

Seatings
Sedute

Caravan Armchair

DESIGN BY EMILIO NANNI

Upholstered leather armchair, with feet structure entirely made of metal.

Poltrona imbottita in pelle, con struttura dei piedini interamente realizzata in metallo.

Caravan Armchair
DC657

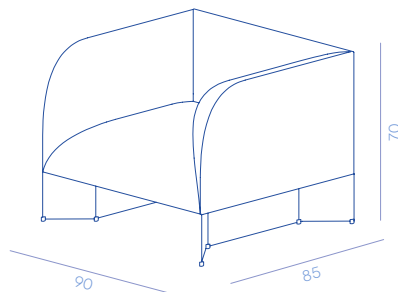

METAL FINISHES

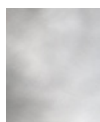

M11

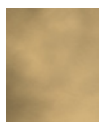

M9



M10

PRODUCT SPECIFICATION

Leather	Anica leather (Mellow col. 1406) 
Assembly	Shipped assembled
Packaging	Wooden crate included TYPE A
Details	<ul style="list-style-type: none">- Wooden monocoque and polyurethane foam seat cushions- Non-removable leather- Metal feet structure- Seat heights 45 cm

SPECIFICHE PRODOTTO

Pelle	Pelle Anica (Mellow col. 1406) 
Assemblaggio	Spedito montato
Imballo	Imballo in cassa incluso TIPO A
Dettagli	<ul style="list-style-type: none">- Struttura monoscocca in legno e imbottitura della seduta in poliuretano espanso- Pelle non sfoderabile- Struttura in metallo- Altezza seduta 45 cm

ON REQUEST

Finishes	The product is available only in the finishes listed
Dimensions	The product is available only in the dimensions listed

SU RICHIESTA

Finiture	Il prodotto è disponibile solo nelle finiture previste
Dimensioni	Il prodotto è disponibile solo nelle dimensioni previste

CARAVAN ARMCHAIR

W. 90 D. 85 H. 70 cm

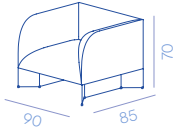

CODE / CODICE	IN	OUT	METAL FINISHES			EURO
DC657-M11-AL	•		Stainless steel Acciaio inox	Brushed Spazzolato	M11	10.700,00
DC657-M9-AL	•		Brass Ottone	Brushed Spazzolato	M9	11.270,00
DC657-M10-AL	•		Copper Rame	Brushed Spazzolato	M10	11.380,00

kg 60 kg

kg 80 kg

cm W. 109 D. 104 H. 102 cm

m³ 1,15 m³

NP 1

Excluding VAT
IVA esclusa

Caravan Sofa

DESIGN BY EMILIO NANNI

Upholstered leather sofa, with feet structure entirely made of metal.

Divano imbottito in pelle, con struttura dei piedini interamente realizzata in metallo.

Caravan 160
DC660

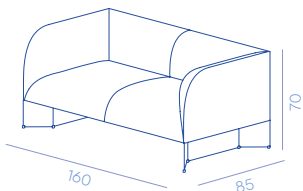

Caravan 240
DC661

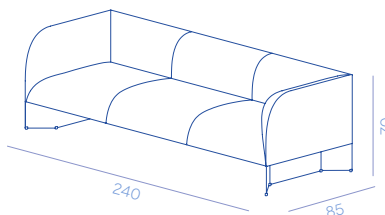

Caravan 320
DC662

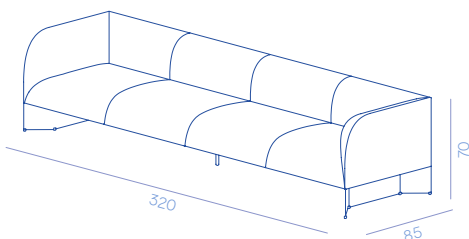

METAL FINISHES

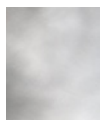

M11



M9



M10

PRODUCT SPECIFICATION

Leather	Anica leather (Mellow col. 1406) 
Assembly	Shipped assembled
Packaging	Wooden crate included TYPE A
Details	<ul style="list-style-type: none"> - Wooden monocoque and polyurethane foam seat cushions - Non-removable leather - Metal feet structure - Seat heights 45 cm

SPECIFICHE PRODOTTO

Pelle	Pelle Anica (Mellow col. 1406) 
Assemblaggio	Spedito montato
Imballo	Imballo in cassa incluso TIPO A
Dettagli	<ul style="list-style-type: none"> - Struttura monoscocca in legno e imbottitura della seduta in poliuretano espanso - Pelle non sfoderabile - Struttura in metallo - Altezza seduta 45 cm

ON REQUEST

Finishes	The product is available only in the finishes listed
Dimensions	The product is available only in the dimensions listed

SU RICHIESTA

Finiture	Il prodotto è disponibile solo nelle finiture previste
Dimensioni	Il prodotto è disponibile solo nelle dimensioni previste

CARAVAN 160

W. 160 D. 85 H. 70 cm

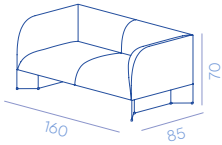

CODE / CODICE	IN	OUT	METAL FINISHES	EURO
---------------	----	-----	----------------	------

Anica leather (Mellow col. 1406) / Pelle Anica (Mellow col. 1406)

DC660-M11-AL	•		Stainless steel Acciaio inox	Brushed Spazzolato	M11	15.000,00
DC660-M9-AL	•		Brass Ottone	Brushed Spazzolato	M9	16.100,00
DC660-M10-AL	•		Copper Rame	Brushed Spazzolato	M10	16.600,00

kg 90 kg

kg 110 kg

cm W. 179 D. 104 H. 102 cm

m³ 1,90 m³

N° 1

Excluding VAT
IVA esclusa

CARAVAN 240

W. 240 D. 85 H. 70 cm

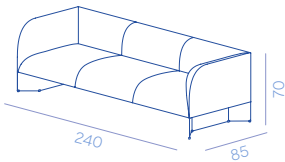

CODE / CODICE	IN	OUT	METAL FINISHES	EURO
---------------	----	-----	----------------	------

Anica leather (Mellow col. 1406) / Pelle Anica (Mellow col. 1406)

DC661-M11-AL	•		Stainless steel Acciaio inox	Brushed Spazzolato	M11	19.900,00
DC661-M9-AL	•		Brass Ottone	Brushed Spazzolato	M9	20.700,00
DC661-M10-AL	•		Copper Rame	Brushed Spazzolato	M10	21.000,00

kg 123 kg

kg 155 kg

cm W. 259 D. 104 H. 102 cm

m³ 2,75 m³

N° 1

Excluding VAT
IVA esclusa

CARAVAN 320

W. 320 D. 85 H. 70 cm

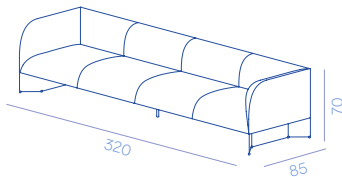

CODE / CODICE	IN	OUT	METAL FINISHES	EURO
---------------	----	-----	----------------	------

Anica leather (Mellow col. 1406) / Pelle Anica (Mellow col. 1406)

DC662-M11-AL	•		Stainless steel Acciaio inox	Brushed Spazzolato	M11	26.500,00
DC662-M9-AL	•		Brass Ottone	Brushed Spazzolato	M9	27.300,00
DC662-M10-AL	•		Copper Rame	Brushed Spazzolato	M10	27.600,00

kg 160 kg

kg 190 kg

cm W. 339 D. 104 H. 102 cm

m³ 3,60 m³

N° 1

Excluding VAT
IVA esclusa

Loom Sofa

DESIGN BY FILIPPO PISAN

Upholstered fabric sofa with back and armrests made of metal.

Divano imbottito in tessuto con schienale e braccioli in metallo.

Loom Sofa
DC652

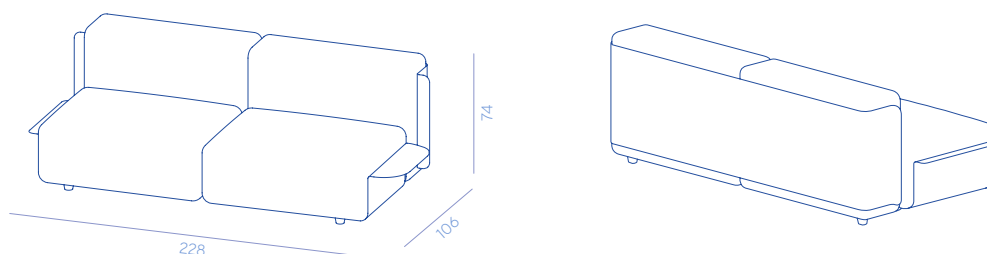

METAL FINISHES

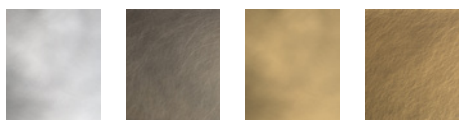

M11

G2

M9

G3

PRODUCT SPECIFICATION

Fabric	Fabric 1569 Asolo col. 16 Composition: 39% viscose – 35% cotton 16% polyamide – 10% linen
Assembly	Shipped assembled
Packaging	Wooden crate included TYPE A
Details	<ul style="list-style-type: none">– Wooden monocoque and polyurethane foam seat cushions (D35 elastic density)– Removable fabric thanks to Velcro fastenings– Dry clean only– Black PVC feet– Seat heights 43 cm

SPECIFICHE PRODOTTO

Tessuto	Tela 1569 Asolo col. 16 Composizione: 39% viscosa – 35% cotone 16% poliamide – 10% lino
Assemblaggio	Spedito montato
Imballo	Imballo in cassa incluso TIPO A
Dettagli	<ul style="list-style-type: none">– Struttura monoscocca in legno e imbottitura della seduta in poliuretano espanso (D35 densità elastica)– Tessuto sfoderabile tramite velcro a strappo– Pulizia a secco– Piedini in PVC nero– Altezza seduta 43 cm

ON REQUEST

Finishes	<ul style="list-style-type: none">– The product can also be made upon request, subject to confirmation of feasibility by De Castelli– Price on request
Dimensions	The product is available only in the dimensions listed

SU RICHIESTA

Finiture	<ul style="list-style-type: none">– Il prodotto può essere realizzato anche in finiture su richiesta, previa conferma fattibilità da parte di De Castelli– Prezzo su richiesta
Dimensioni	Il prodotto è disponibile solo nelle dimensioni previste

LOOM SOFA

W. 228 D. 106 H. 74 cm

CODE / CODICE	IN	OUT	METAL FINISHES			EURO
DC652-M11	•		Stainless steel Acciaio inox	Brushed Spazzolato	M11	14.000,00
DC652-G2	•		Stainless steel Acciaio inox	Orbitale DeLabré DeLabré Orbitale	G2	14.800,00
DC652-M9	•		Brass Ottone	Brushed Spazzolato	M9	16.000,00
DC652-G3	•		Brass Ottone	Orbitale DeLabré DeLabré Orbitale	G3	16.800,00

 152 kg

 180 kg

 W. 247 D. 125 H. 106 cm

 3,30 m³

 1

Excluding VAT
IVA esclusa

Loom Pouf

DESIGN BY FILIPPO PISAN

Upholstered fabric pouf with base and armrests made of metal.

Pouf imbottito in tessuto con base e braccioli in metallo.

Loom Pouf
DC653

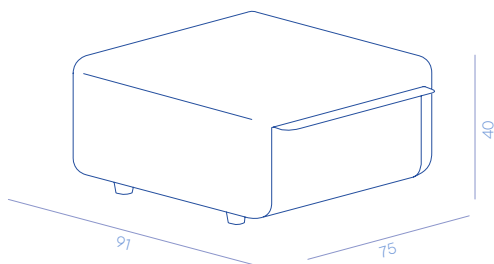

METAL FINISHES

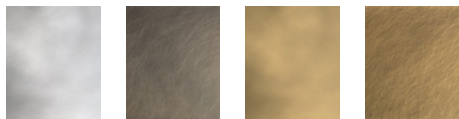

M11

G2

M9

G3

PRODUCT SPECIFICATION

Fabric	Fabric 1569 Asolo col. 16 Composition: 39% viscose – 35% cotton 16% polyamide – 10% linen
Assembly	Shipped assembled
Packaging	Wooden crate included TYPE A
Details	<ul style="list-style-type: none">– Wooden monocoque and polyurethane foam seat cushions (D35 elastic density)– Removable fabric thanks to Velcro fastenings– Dry clean only– Black PVC feet– Seat heights 43 cm

SPECIFICHE PRODOTTO

Tessuto	Tela 1569 Asolo col. 16 Composizione: 39% viscosa – 35% cotone 16% poliamide – 10% lino
Assemblaggio	Spedito montato
Imballo	Imballo in cassa incluso TIPO A
Dettagli	<ul style="list-style-type: none">– Struttura monoscocca in legno e imbottitura della seduta in poliuretano espanso (D35 densità elastica)– Tessuto sfoderabile tramite velcro a strappo– Pulizia a secco– Piedini in PVC nero– Altezza seduta 43 cm

ON REQUEST

Finishes	<ul style="list-style-type: none">– The product can also be made upon request, subject to confirmation of feasibility by De Castelli– Price on request
Dimensions	The product is available only in the dimensions listed

SU RICHIESTA

Finiture	<ul style="list-style-type: none">– Il prodotto può essere realizzato anche in finiture su richiesta, previa conferma fattibilità da parte di De Castelli– Prezzo su richiesta
Dimensioni	Il prodotto è disponibile solo nelle dimensioni previste

LOOM POUF

W. 91 D. 75 H. 40 cm

CODE / CODICE	IN	OUT	METAL FINISHES			EURO
DC653-M11	•		Stainless steel Acciaio inox	Brushed Spazzolato	M11	5.950,00
DC653-G2	•		Stainless steel Acciaio inox	Orbitale DeLabré DeLabré Orbitale	G2	6.300,00
DC653-M9	•		Brass Ottone	Brushed Spazzolato	M9	6.800,00
DC653-G3	•		Brass Ottone	Orbitale DeLabré DeLabré Orbitale	G3	7.200,00

 35 kg

 50 kg

 W. 110 D. 154 H. 72 cm

 1,21 m³

 1

Excluding VAT
IVA esclusa

Ori

DESIGN BY STORMO STUDIO

Upholstered fabric pouf with base made of metal.

Pouf imbottito in tessuto con base in metallo.

Ori
DC685

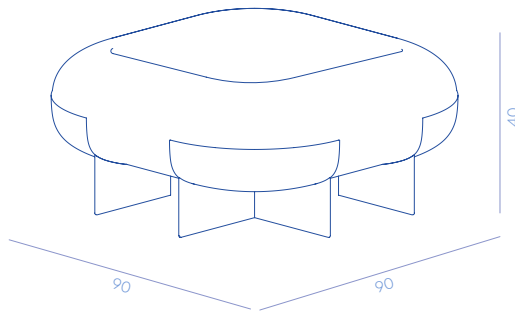

METAL FINISHES



G3

PRODUCT SPECIFICATION

Fabric
Tela St. Moritz L1261 – col. 126 (lilac)
Composition: 80% wool 20% polyamide
Tela St. Moritz L1261 – col. 130 (light blue)
Composition: 80% wool 20% polyamide



Assembly Shipped assembled

Packaging Wooden crate included [TYPE A](#)

Details Non-removable fabric

SPECIFICHE PRODOTTO

Tessuto
Tela St. Moritz L1261 – col. 126 (lilla)
Composizione: 80% lana 20% polyamide
Tela St. Moritz L1261 – col. 130 (azzurro)
Composizione: 80% lana 20% polyamide



Assemblaggio Spedito montato

Imballo Imballo in cassa incluso [TIPO A](#)

Dettagli Tessuto non sfoderabile

ON REQUEST

Finishes The product is available only in the finishes listed

Dimensions The product is available only in the dimensions listed

SU RICHIESTA

Finiture Il prodotto è disponibile solo nelle finiture previste

Dimensioni Il prodotto è disponibile solo nelle dimensioni previste

ORI

W. 90 D. 90 H. 40 cm

CODE / CODICE	IN	OUT	METAL FINISHES			EURO
DC685-G3 - 126	•		Brass Ottone	Orbitale DeLabré DeLabré Orbitale	G3	9.880,00
DC685-G3 - 130	•		Brass Ottone	Orbitale DeLabré DeLabré Orbitale	G3	9.880,00

 32 kg

 55 kg

 W. 109 D. 109 H. 72 cm

 0,85 m³

 1

Excluding VAT
IVA esclusa

Efesto

DESIGN BY MARTINELLI VENEZIA

Sculptural stool obtained from the manual shaping and welding of the metal sheet, without mechanical joints. Load capacity is ensured by the shape design.

Sgabello scultura ottenuto dalla formatura e saldatura manuale della lastra di metallo, privo di giunti meccanici. La sua resistenza al peso è data dalla struttura progettuale.

Efesto
DC684

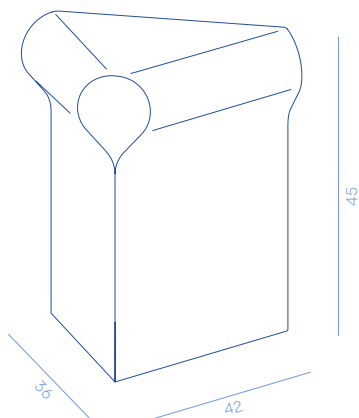

METAL FINISHES



D2



E13

PRODUCT SPECIFICATION

Assembly	Shipped assembled
Packaging	Carton box TYPE E
Details	Sculptural stool entirely made of metal

SPECIFICHE PRODOTTO

Assemblaggio	Spedito montato
Imballo	Imballo in scatola di cartone TIPO E
Dettagli	Sgabello scultoreo interamente in metallo

ON REQUEST

Finishes	The product is available only in the finishes listed
Dimensions	The product is available only in the dimensions listed

SU RICHIESTA

Finiture	Il prodotto è disponibile solo nelle finiture previste
Dimensioni	Il prodotto è disponibile solo nelle dimensioni previste

EFESTO

W. 36 D. 42 H. 45 cm

CODE / CODICE	IN	OUT	METAL FINISHES			EURO
DC0684-D2	•		Stainless steel Acciaio inox	Polished Lucido	D2	2.200,00
DC684-E13	•		Brass Ottone	Polished Lucido	E13	2.500,00

 8 kg

 15 kg

 W. 52 D. 52 H. 55 cm

 0,15 m³

 1

Excluding VAT
IVA esclusa

Pensando ad Acapulco

DESIGN BY IVDESIGN

Armchair entirely made of metal with an iconic shape, characterized by pleated segments.

Poltroncina interamente realizzata in metallo dalla forma iconica, caratterizzata da segmenti plissettati.

Pensando ad Acapulco
DC514

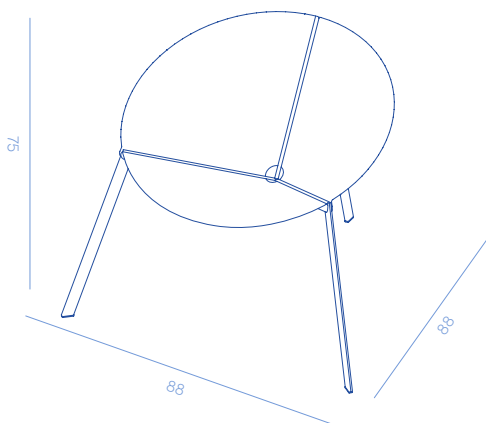

METAL FINISHES



M14



M13

PRODUCT SPECIFICATION

Structure	DeLabré M12 
Assembly	Shipped assembled
Packaging	Carton box TYPE E
Details	<ul style="list-style-type: none">- Armchair entirely made of metal- It consists of 3 radial pleated segments- Seat height 44 cm

SPECIFICHE PRODOTTO

Struttura	DeLabré M12 
Assemblaggio	Spedito montato
Imballo	Imballo in scatola di cartone TIPO E
Dettagli	<ul style="list-style-type: none">- Poltrona realizzata interamente in metallo- Caratterizzata da 3 segmenti radiali piegati- Altezza seduta 44 cm

ON REQUEST

Finishes	The product is available only in the finishes listed
Dimensions	The product is available only in the dimensions listed

SU RICHIESTA

Finiture	Il prodotto è disponibile solo nelle finiture previste
Dimensioni	Il prodotto è disponibile solo nelle dimensioni previste

PENSANDO AD ACAPULCO

W. 88 D. 88 H. 75 cm

CODE / CODICE	IN	OUT	METAL FINISHES			EURO
DC514-OT	•		Brass Ottone	Polished Lucido	M14	5.200,00
DC514-RA	•		Copper Rame	Polished Lucido	M13	5.400,00

 19 kg

 21 kg

 W. 95 D. 95 H. 80 cm

 0,75 m²

 1

Excluding VAT
IVA esclusa

Via Veneto

DESIGN BY MINELLI FOSSATI

Armchair in tubular steel with upholstered leather seat.

Poltroncina in tubolare d'acciaio con seduta imbottita in pelle.

Via Veneto
DC654

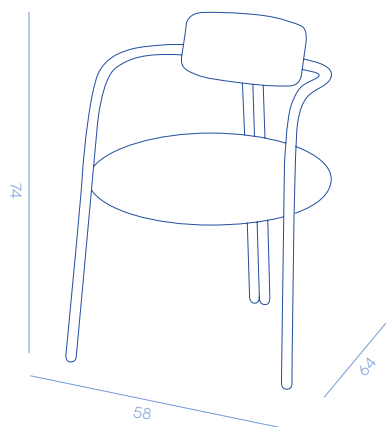

METAL FINISHES



G2

G3

G4

PRODUCT SPECIFICATION

Structure	DeLabré M15
Leather	Anica Leather (Mellow col. 1427)
	
Assembly	Shipped assembled
Packaging	Carton box TYPE E
Details	- Armchair in tubular steel with upholstered leather seat - Seat height 44 cm

SPECIFICHE PRODOTTO

Struttura	DeLabré M15
Pelle	Pelle Anica (Mellow col. 1427)
	
Assemblaggio	Spedito montato
Imballo	Imballo in scatola di cartone TIPO E
Dettagli	- Poltrona in tubolare d'acciaio con seduta imbottita in pelle - Altezza seduta 44 cm

ON REQUEST

Finishes	The product is available only in the finishes listed
Dimensions	The product is available only in the dimensions listed

SU RICHIESTA

Finiture	Il prodotto è disponibile solo nelle finiture previste
Dimensioni	Il prodotto è disponibile solo nelle dimensioni previste

VIA VENETO

W. 58 D. 64 H. 74 cm

CODE / CODICE	IN	OUT	METAL FINISHES			EURO
DC654-G2	•		Stainless steel Acciaio inox	Orbitale DeLabré DeLabré Orbitale	G2	1.680,00
DC654-G3	•		Brass Ottone	Orbitale DeLabré DeLabré Orbitale	G3	1.780,00
DC654-G4	•		Copper Rame	Orbitale DeLabré DeLabré Orbitale	G4	1.880,00

 7 kg

 9 kg

 W. 63 D. 69 H. 81 cm

 0,35 m³

 1

Excluding VAT
IVA esclusa

Wave

DESIGN BY LANZAVECCHIA+WAI

Bench entirely made of 4 mm thick metal sheets, equipped with a empty-pockets bowl and a decorative perforated pattern.

Panca interamente realizzata in lamiere da 4 mm di spessore, dotata di ciotola svuotatasche e motivo decorativo traforato.

Wave
DC648

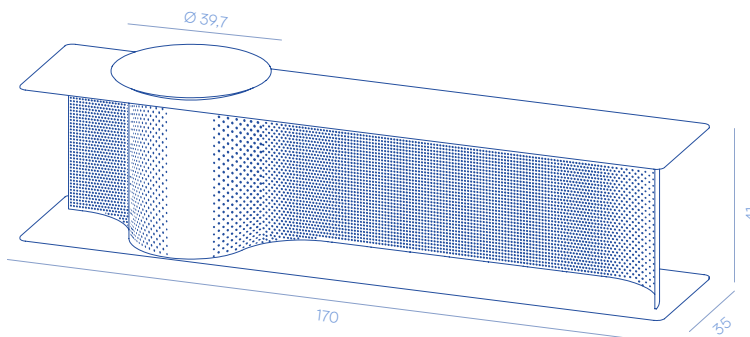

METAL FINISHES

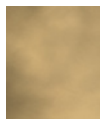

M9



M10

PRODUCT SPECIFICATION

Assembly	Shipped assembled
Packaging	Wooden crate included TYPE A
Details	<ul style="list-style-type: none">– Bench entirely made of metal 4 mm thick– It features a movable free empty-pockets bowl and a decorative perforated pattern

SPECIFICHE PRODOTTO

Assemblaggio	Spedito montato
Imballo	Imballo in cassa incluso TIPO A
Dettagli	<ul style="list-style-type: none">– Panca realizzata interamente in metallo spessore 4 mm– Caratterizzata da una ciotola svuota-tasche e da un pattern realizzato con la microforatura

ON REQUEST

Finishes	The product is available only in the finishes listed
Dimensions	The product is available only in the dimensions listed

SU RICHIESTA

Finiture	Il prodotto è disponibile solo nelle finiture previste
Dimensioni	Il prodotto è disponibile solo nelle dimensioni previste

WAVE

W. 170 D. 35 H. 41 cm

CODE / CODICE	IN	OUT	METAL FINISHES			EURO
DC648-M9	•		Brass Ottone	Brushed Spazzolato	M9	13.400,00
DC648-M10	•		Copper Rame	Brushed Spazzolato	M10	14.000,00

 75 kg

 90 kg

 W. 189 D. 59 H. 77 cm

 0,85 m³

 1

Excluding VAT
IVA esclusa

Coffee tables
Tavolini

Alchemy

DESIGN BY STORMO

Collection of four side tables and a bench entirely made in metal, characterized by a mirror polished stainless steel base.

Collezione composta da quattro tavolini e una panca interamente realizzati in metallo, caratterizzati da una base in acciaio inox lucido.

Alchemy 35
DC626

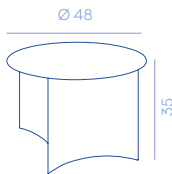

Alchemy 50
DC628

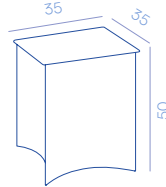

Alchemy Bench
DC627

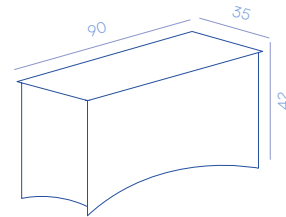

Alchemy 70
DC629

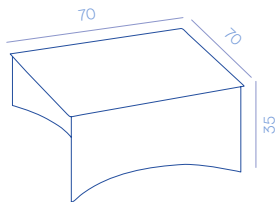

Alchemy 90
DC633

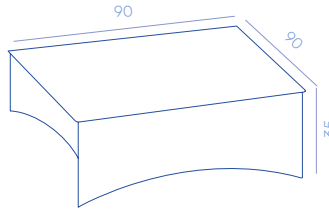

METAL FINISHES

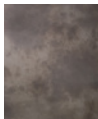

E1



F2



G5

PRODUCT SPECIFICATION

Base	Polished stainless steel D2 
Assembly	Shipped assembled
Packaging	Carton box TYPE E
Details	<ul style="list-style-type: none"> - Coffee tables entirely made of metal - The base consists of concave sides

SPECIFICHE PRODOTTO

Base	Acciaio inox lucido D2 
Assemblaggio	Spedito montato
Imballo	Imballo in scatola di cartone TIPO E
Dettagli	<ul style="list-style-type: none"> - Tavolini interamente realizzati in metallo - La base è caratterizzata da facce concave

ON REQUEST

Finishes	<ul style="list-style-type: none"> - The product can also be made in finishes on request, subject to confirmation of feasibility by De Castelli - Structure always in polished stainless steel D2 - Price on request
Dimensions	The product is available only in the dimensions listed

SU RICHIESTA

Finiture	<ul style="list-style-type: none"> - Il prodotto può essere realizzato anche in finiture su richiesta, previa conferma fattibilità da parte di De Castelli - Struttura sempre in acciaio inox lucido D2 - Prezzo su richiesta
Dimensioni	Il prodotto è disponibile solo nelle dimensioni previste

ALCHEMY 35

Ø. 48 H. 35 cm

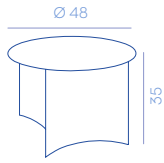

CODE / CODICE	IN	OUT	METAL FINISHES			EURO
DC626-E11	•		Stainless steel Acciaio inox	DeLabré DeLabré	E11	1.450,00
DC626-F2	•		Brass Ottone	DeLabré DeLabré	F2	1.650,00
DC626-G5	•		Copper Rame	DeLabré DeLabré	G5	1.820,00

kg 11,5 kg 12 kg W. 55 D. 55 H. 40 cm 0,15 m³ 1 Excluding VAT
IVA esclusa

ALCHEMY 50

W. 35 D. 35 H. 50 cm

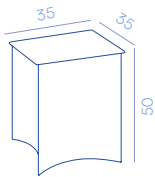

CODE / CODICE	IN	OUT	METAL FINISHES			EURO
DC628-E11	•		Stainless steel Acciaio inox	DeLabré DeLabré	E11	1.500,00
DC628-F2	•		Brass Ottone	DeLabré DeLabré	F2	1.700,00
DC628-G5	•		Copper Rame	DeLabré DeLabré	G5	1.820,00

kg 12,5 kg 13,5 kg W. 40 D. 40 H. 55 cm 0,10 m³ 1 Excluding VAT
IVA esclusa

ALCHEMY BENCH

W. 90 D. 35 H. 42 cm

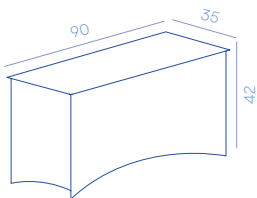

CODE / CODICE	IN	OUT	METAL FINISHES			EURO
DC627-E11	•		Stainless steel Acciaio inox	DeLabré DeLabré	E11	2.250,00
DC627-F2	•		Brass Ottone	DeLabré DeLabré	F2	2.550,00
DC627-G5	•		Copper Rame	DeLabré DeLabré	G5	2.700,00

kg 22 kg 23,5 kg W. 95 D. 40 H. 47 cm 0,67 m³ 1 Excluding VAT
IVA esclusa

ALCHEMY 70

W. 70 D. 70 H. 35 cm

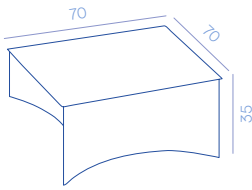

CODE / CODICE	IN	OUT	METAL FINISHES			EURO
DC629-E11	•		Stainless steel Acciaio inox	DeLabré DeLabré	E11	1.900,00
DC629-F2	•		Brass Ottone	DeLabré DeLabré	F2	2.400,00
DC629-G5	•		Copper Rame	DeLabré DeLabré	G5	2.700,00

kg 26,5 kg

kg 28 kg

cm W. 75 D. 75 H. 40 cm

m³ 0,25 m³

N° 1

Excluding VAT
IVA esclusa

ALCHEMY 90

W. 00 D. 00 H. 00 cm

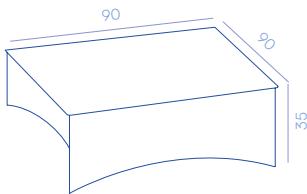

CODE / CODICE	IN	OUT	METAL FINISHES / MATERIALI E FINITURE			EURO
DC633-E11	•		Stainless steel Acciaio inox	DeLabré DeLabré	E11	2.500,00
DC633-F2	•		Brass Ottone	DeLabré DeLabré	F2	3.200,00
DC633-G5	•		Copper Rame	DeLabré DeLabré	G5	3.450,00

kg 38 kg

kg 40 kg

cm W. 100 D. 100 H. 40 cm

m³ 0,40 m³

N° 1

Excluding VAT
IVA esclusa

Alpha

DESIGN BY MARTINELLI VENEZIA

Modular coffee table in lacquered wood clad in metal characterized by a particular DeErosion finishing.
Tavolino modulare in legno laccato rivestito in metallo caratterizzato da una particolare finitura DeErosion.

Alpha
DC649

Compositions / Composizioni

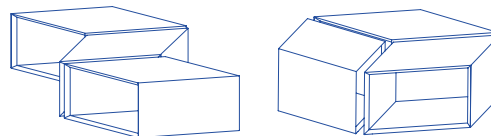
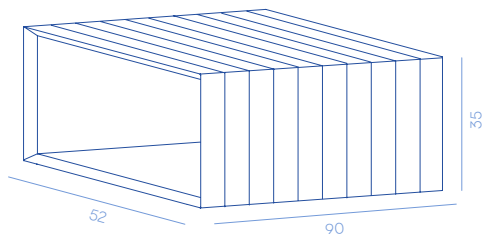

METAL FINISHES



H12

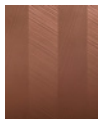

H12

PRODUCT SPECIFICATION

Structure	Matt lacquered RAL 7016 wood
Assembly	Shipped assembled
Packaging	Wooden crate included TYPE A
Details	– Clad in metal on all external sides, bottom excluded

SPECIFICHE PRODOTTO

Struttura	Legno laccato opaco RAL 7016
Assemblaggio	Spedito montato
Imballo	Imballo in cassa incluso TIPO A
Dettagli	– Rivestito in metallo su tutti i lati esterni, tranne sul fondo

ON REQUEST

Finishes	The product is available only in the finishes listed
Dimensions	The product is available only in the dimensions listed

SU RICHIESTA

Finiture	Il prodotto è disponibile solo nelle finiture previste
Dimensioni	Il prodotto è disponibile solo nelle dimensioni previste

ALPHA

W. 90 D. 52 H. 35 cm

CODE / CODICE	IN	OUT	METAL FINISHES		EURO
DC649-OT-H12	•		Brass Ottone	DeErosion DeErosion	H12 3.600,00
DC649-RA-H12			Copper Rame	DeErosion DeErosion	H12 3.800,00

 22 kg

 50 kg

 W. 109 D. 71 H. 62 cm

 0,50 m³

 1

Excluding VAT
IVA esclusa

Band

DESIGN BY BALDESSARI E BALDESSARI

Collection of round side tables with thin metal legs.

Collezione di tavolini tondi caratterizzati da sottili gambe in metallo.

Band 55
DC640

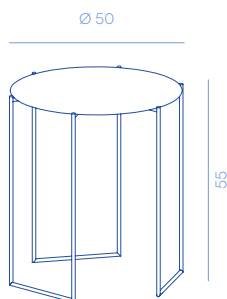

Band 60
DC641

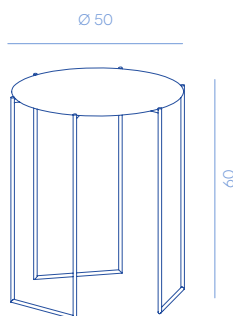

Band 65
DC642

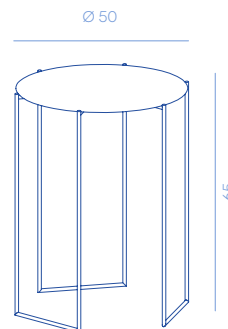

METAL FINISHES

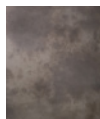

E1

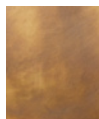

F2



G5

PRODUCT SPECIFICATION

Legs	DeLabré M12 
Assembly	Shipped assembled
Packaging	Carton box TYPE E
Details	<ul style="list-style-type: none">- Coffee tables entirely made of metal- Structure made of iron rods structure

SPECIFICHE PRODOTTO

Gambe	DeLabré M12 
Assemblaggio	Spedito montato
Imballo	Imballo in scatola di cartone TIPO E
Dettagli	<ul style="list-style-type: none">- Tavolini interamente realizzati in metallo- Struttura in tondini di ferro

ON REQUEST

Finishes	<ul style="list-style-type: none">- The product can also be made in finishes on request, subject to confirmation of feasibility by De Castelli- Legs always in DeLabré iron M12- Price on request
Dimensions	The product is available only in the dimensions listed

SU RICHIESTA

Finiture	<ul style="list-style-type: none">- Il prodotto può essere realizzato anche in finiture su richiesta, previa conferma fattibilità da parte di De Castelli- Gambe sempre in ferro DeLabré M12- Prezzo su richiesta
Dimensioni	Il prodotto è disponibile solo nelle dimensioni previste

BAND 55

Ø. 50 H. 55 cm

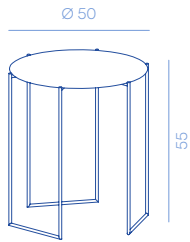

CODE / CODICE	IN	OUT	METAL FINISHES			EURO
DC640-E11	•		Stainless steel Acciaio inox	DeLabré DeLabré	E11	1.050,00
DC640-F2	•		Brass Ottone	DeLabré DeLabré	F2	1.150,00
DC640-G5	•		Copper Rame	DeLabré DeLabré	G5	1.250,00

kg 11,5 kg

kg 12,5 kg

cm W. 55 D. 55 H. 60 cm

m³ 0,20 m³

N° 1

Excluding VAT
IVA esclusa

BAND 60

Ø. 50 H. 60 cm

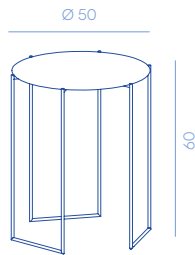

CODE / CODICE	IN	OUT	METAL FINISHES			EURO
DC641-E11	•		Stainless steel Acciaio inox	DeLabré DeLabré	E11	1.100,00
DC641-F2	•		Brass Ottone	DeLabré DeLabré	F2	1.200,00
DC641-G5	•		Copper Rame	DeLabré DeLabré	G5	1.300,00

kg 11,5 kg

kg 12,5 kg

cm W. 55 D. 55 H. 65 cm

m³ 0,20 m³

N° 1

Excluding VAT
IVA esclusa

BAND 65

Ø. 50 H. 65 cm

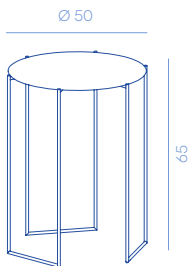

CODE / CODICE	IN	OUT	METAL FINISHES			EURO
DC642-AA	•		Stainless steel Acciaio inox	DeLabré DeLabré	E11	1.150,00
DC642-AA	•		Brass Ottone	DeLabré DeLabré	F2	1.250,00
DC642-AA	•		Copper Rame	DeLabré DeLabré	G5	1.350,00

kg 12 kg

kg 13 kg

cm W. 55 D. 55 H. 70 cm

m³ 0,20 m³

N° 1

Excluding VAT
IVA esclusa

Between Nature

DESIGN BY STORMO STUDIO

Collection of coffee tables with a monolithic base in marble from the Ipogeo collection by Margraf Innovation Lab. The tables accommodate metal trays of various shapes.

Collezione di tavolini caratterizzati da una base monolitica in marmo della collezione Ipogeo by Margraf Innovation Lab. I tavolini accolgono vassoi in metallo di varie forme.

Between Nature 20
DC682

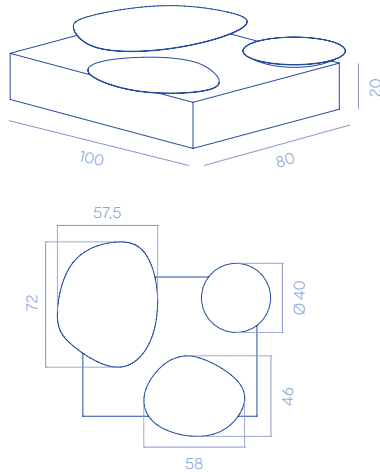

Between Nature 40
DC683

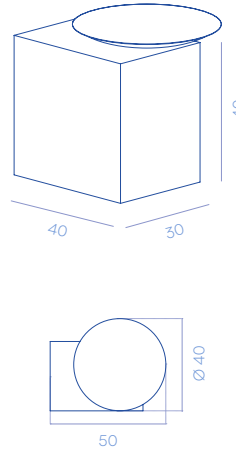

METAL FINISHES



M9



G8



M9

PRODUCT SPECIFICATION

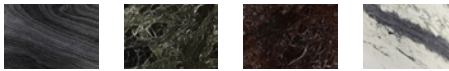
Base	"Zebrato" eroded marble from Sisma Ipogeo "Breccia imperiale" eroded marble from Palus Ipogeo "Rosso Lepanto" eroded marble from Palus Ipogeo ^{NEW} "Breccia Capraia" eroded marble from Origo Ipogeo ^{NEW}
	
Assembly	Shipped disassembled
Packaging	Wooden crate included TYPE A
Details	– Marble by Margraf Innovation Lab

SPECIFICHE PRODOTTO

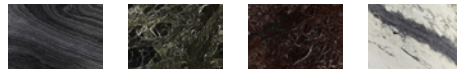
Base	Marmo eroso "Zebrato" di Sisma Ipogeo Marmo eroso "Breccia imperiale" di Palus Ipogeo Marmo eroso "Rosso Lepanto" di Palus Ipogeo ^{NEW} Marmo eroso "Breccia Capraia" di Origo Ipogeo ^{NEW}
	
Assemblaggio	Spedito smontato
Imballo	Imballo in cassa incluso TIPO A
Dettagli	– Marmo di Margraf Innovation Lab

ON REQUEST

Finishes	The product is available only in the finishes listed
Dimensions	The product is available only in the dimensions listed

SU RICHIESTA

Finiture	Il prodotto è disponibile solo nelle finiture previste
Dimensioni	Il prodotto è disponibile solo nelle dimensioni previste

BETWEEN NATURE 20

W. 100 D. 80 H. 20 cm

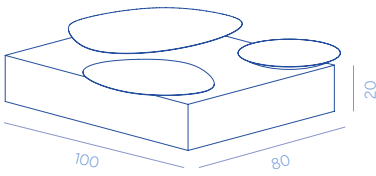

CODE / CODICE	IN	OUT	METAL FINISHES	EURO	
DC682-OT-ZEBR	•		Brass Ottone	OT- ZEBR	12.500,00
			Brushed Spazzolato		
DC682-OT-CAPR	•		"Zebrato" eroded marble from Sisma Ipogeo Marmo eroso "Zebrato" di Sisma Ipogeo	OT- CAPR	12.500,00
			Brass Ottone		

kg 120 kg

kg 135 kg

cm W. 119 D. 99 H. 72 cm

m³ 0,85 m³

N° 1

Excluding VAT
IVA esclusa

BETWEEN NATURE 40

W. 40 D. 30 H. 40 cm

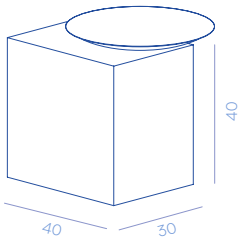

CODE / CODICE	IN	OUT	METAL FINISHES	EURO	
DC683-OT-IMP	•		Brass Ottone	OT- IMP	6.800,00
			Brushed Spazzolato		
DC683-OT-LEPA	•		"Breccia imperiale" eroded marble from Sisma Ipogeo Marmo eroso "Breccia imperiale" di Sisma Ipogeo	OT- LEPA	6.800,00
			Brass Ottone		

kg 48 kg

kg 58 kg

cm W. 69 D. 54 H. 6720 cm

m³ 0,26 m³

N° 1

Excluding VAT
IVA esclusa

Botero

DESIGN BY R&D DE CASTELLI

Sculptural side table entirely made of metal, characterized by the organic shape of the top with a central hole.

Tavolino scultoreo interamente realizzato in metallo, caratterizzato dalla forma organica del piano con foro centrale.

Botero 50
DC681

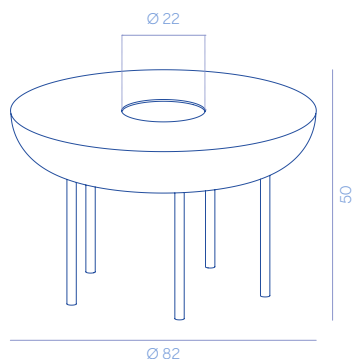

Botero 17
DC689

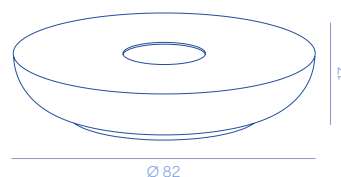

METAL FINISHES

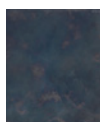

G12



M9



H13

PRODUCT SPECIFICATION

Assembly	Shipped assembled
Packaging	Wooden crate included TYPE A
Details	<ul style="list-style-type: none">- Coffee tables entirely made of metal, characterized by a hole in the middle- Brass base with gradual oxidation- Top characterized by a pattern in DeErosion technique
DC681	
DC689	

SPECIFICHE PRODOTTO

Assemblaggio	Spedito montato
Imballo	Imballo in cassa incluso TIPO A
Dettagli	<ul style="list-style-type: none">- Tavolini interamente realizzati in metallo, caratterizzati da un foro centrale- Base in ottone con ossidazione graduale- Top caratterizzato dal pattern in DeErosion
DC681	
DC689	

ON REQUEST

Finishes	The product is available only in the finishes listed
Dimensions	The product is available only in the dimensions listed

SU RICHIESTA

Finiture	Il prodotto è disponibile solo nelle finiture previste
Dimensioni	Il prodotto è disponibile solo nelle dimensioni previste

BOTERO 50

Ø. 82 H. 50 cm

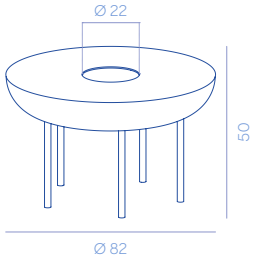

CODE / CODICE	IN	OUT	METAL FINISHES			EURO
DC681-G12	•		Stainless steel Acciaio inox	DeDeep DeDeep	G12	7.800,00
DC681-M9	•		Brass Ottone	Brushed Spazzolato	M9	8.300,00

kg 32 kg
kg 47 kg
cm W. 99 D. 99 H. 82 cm
m³ 0,80 m³
N° 1
Excluding VAT
IVA esclusa

BOTERO 17

Ø. 82 H. 17 cm

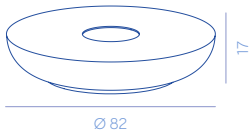

CODE / CODICE	IN	OUT	METAL FINISHES			EURO
DC689-M9	•		Brass Ottone	Brushed Spazzolato	M9	7.400,00
DC689-H3	•		Brass Ottone	DeErosion DeErosion	H3	7.800,00

kg 27 kg
kg 42 kg
cm W. 99 D. 99 H. 49 cm
m³ 0,50 m³
N° 1
Excluding VAT
IVA esclusa

Drops

DESIGN BY ZANELLATO/BORTOTTO

Collection of coffee tables characterized by tops with organic shapes and a cylindrical base.

Collezione di tavolini caratterizzati da piani dalle forme organiche e base cilindrica.

Drops 30
DC663

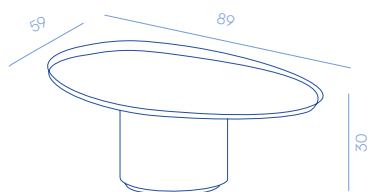

Drops 38
DC664

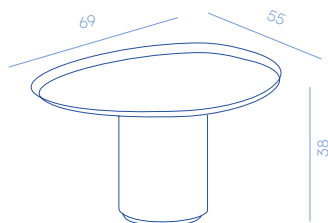

Drops 52
DC665

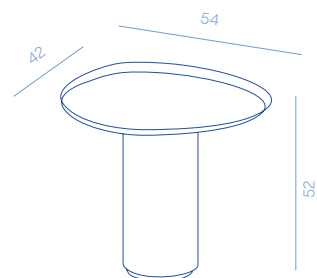

METAL FINISHES

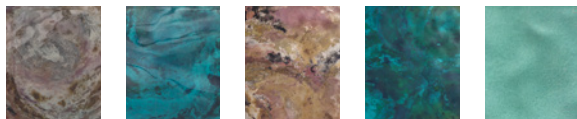

N1

N2

N10

N20

N30

PRODUCT SPECIFICATION

Structure	Matt black lacquered stainless steel M15 Brushed copper M10
Assembly	Shipped assembled
Packaging	Wooden cage included TYPE C
Details	- Handmade hammered top with organic shape - Legs and top finishes can be combined as desired

SPECIFICHE PRODOTTO

Struttura	Acciaio inox laccato nero opaco M15 Acciaio inox spazzolato M10
Assemblaggio	Spedito montato
Imballo	Imballo in gabbia di legno TIPO C
Dettagli	- Top martellato a mano con forma organica - Gambe e top sono combinabili a piacere

ON REQUEST

Finishes	The product is available only in the finishes listed
Dimensions	The product is available only in the dimensions listed

SU RICHIESTA

Finiture	Il prodotto è disponibile solo nelle finiture previste
Dimensioni	Il prodotto è disponibile solo nelle dimensioni previste

DROP 30

W. 89 D. 59 H. 30 cm

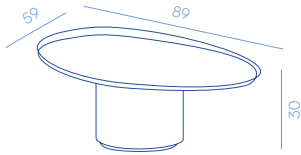

CODE / CODICE	IN	OUT	METAL FINISHES	EURO
---------------	----	-----	----------------	------

Legs in matt black lacquered stainless steel M15 / Gambe in acciaio inox laccato nero opaco M15

DC663-N1-M15	•		Copper Rame DeNuance Forest DeNuance Foresta	N1	2.640,00
DC663-N2-M15	•		Copper Rame DeNuance Ocean DeNuance Oceano	N2	2.640,00
DC663-N10-M15	•		Copper Rame Matt DeNuance Forest DeNuance Foresta opaco	N10	2.640,00
DC663-N20-M15	•		Copper Rame Matt DeNuance Ocean DeNuance Oceano opaco	N20	2.640,00
DC663-N30-M15	•		Copper Rame DeNuance Verdigris DeNuance Verderame	N30	2.700,00

Legs in DeLabré stainless steel E5 / Gambe in acciaio inox DeLabré E5

DC663-N1-E5	•		Copper Rame DeNuance Forest DeNuance Foresta	N1	2.640,00
DC663-N2-E5	•		Copper Rame DeNuance Ocean DeNuance Oceano	N2	2.640,00
DC663-N10-E5	•		Copper Rame Matt DeNuance Forest DeNuance Foresta opaco	N10	2.640,00
DC663-N20-E5	•		Copper Rame Matt DeNuance Ocean DeNuance Oceano opaco	N20	2.640,00
DC663-N30-E5	•		Copper Rame DeNuance Verdigris DeNuance Verderame	N30	2.700,00

Legs in brushed copper M10 / Gambe in rame spazzolato M10

DC663-N1-M10	•		Copper Rame DeNuance Forest DeNuance Foresta	N1	2.730,00
DC663-N2-M10	•		Copper Rame DeNuance Ocean DeNuance Oceano	N2	2.730,00
DC663-N10-M10	•		Copper Rame Matt DeNuance Forest DeNuance Foresta opaco	N10	2.730,00
DC663-N20-M10	•		Copper Rame Matt DeNuance Ocean DeNuance Oceano opaco	N20	2.730,00
DC663-N30-M10	•		Copper Rame DeNuance Verdigris DeNuance Verderame	N30	2.800,00

16,5 kg

30 kg

W. 78 D. 110 H. 57 cm

0,50 m³

1

Excluding VAT
IVA esclusa

W. 69 D. 55 H. 38 cm

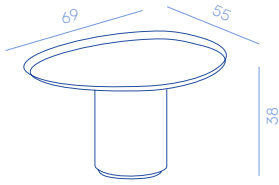

CODE / CODICE	IN	OUT	METAL FINISHES	EURO
---------------	----	-----	----------------	------

Legs in matt black lacquered stainless steel M15 / Gambe in acciaio inox laccato nero opaco M15

DC664-N1-M15	•		Copper Rame DeNuance Forest DeNuance Foresta	N1	2.530,00
DC664-N2-M15	•		Copper Rame DeNuance Ocean DeNuance Oceano	N2	2.530,00
DC664-N10-M15	•		Copper Rame Matt DeNuance Forest DeNuance Foresta opaco	N10	2.530,00
DC664-N20-M15	•		Copper Rame Matt DeNuance Ocean DeNuance Oceano opaco	N20	2.530,00
DC664-N30-M15	•		Copper Rame DeNuance Verdigris DeNuance Verderame	N30	2.600,00

Legs in DeLabré stainless steel E5 / Gambe in acciaio inox DeLabré E5

DC664-N1-E5	•		Copper Rame DeNuance Forest DeNuance Foresta	N1	2.530,00
DC664-N2-E5	•		Copper Rame DeNuance Ocean DeNuance Oceano	N2	2.530,00
DC664-N10-E5	•		Copper Rame Matt DeNuance Forest DeNuance Foresta opaco	N10	2.530,00
DC664-N20-E5	•		Copper Rame Matt DeNuance Ocean DeNuance Oceano opaco	N20	2.530,00
DC664-N30-E5	•		Copper Rame DeNuance Verdigris DeNuance Verderame	N30	2.600,00

Legs in brushed copper M10 / Gambe in rame spazzolato M10

DC664-N1-M10	•		Copper Rame DeNuance Forest DeNuance Foresta	N1	2.600,00
DC664-N2-M10	•		Copper Rame DeNuance Ocean DeNuance Oceano	N2	2.600,00
DC664-N10-M10	•		Copper Rame Matt DeNuance Forest DeNuance Foresta opaco	N10	2.600,00
DC664-N20-M10	•		Copper Rame Matt DeNuance Ocean DeNuance Oceano opaco	N20	2.600,00
DC664-N30-M10	•		Copper Rame DeNuance Verdigris DeNuance Verderame	N30	2.670,00

kg 15 kg

kg 28 kg

cm W. 88 D. 74 H. 63 cm

m³ 0,41 m³

N° 1

Excluding VAT
IVA esclusa

W. 42 D. 54 H. 52 cm

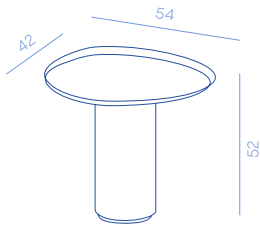

CODE / CODICE	IN	OUT	METAL FINISHES	EURO
---------------	----	-----	----------------	------

Legs in matt black lacquered stainless steel M15 / Gambe in acciaio inox laccato nero opaco M15

DC665-N1-M15	•		Copper Rame DeNuance Forest DeNuance Foresta	N1	2.600,00
DC665-N2-M15	•		Copper Rame DeNuance Ocean DeNuance Oceano	N2	2.600,00
DC665-N10-M15	•		Copper Rame Matt DeNuance Forest DeNuance Foresta opaco	N10	2.600,00
DC665-N20-M15	•		Copper Rame Matt DeNuance Ocean DeNuance Oceano opaco	N20	2.600,00
DC665-N30-M15	•		Copper Rame DeNuance Verdigris DeNuance Verderame	N30	2.680,00

Legs in DeLabré stainless steel E5 / Gambe in acciaio inox DeLabré E5

DC665-N1-E5	•		Copper Rame DeNuance Forest DeNuance Foresta	N1	2.600,00
DC665-N2-E5	•		Copper Rame DeNuance Ocean DeNuance Oceano	N2	2.600,00
DC665-N10-E5	•		Copper Rame Matt DeNuance Forest DeNuance Foresta opaco	N10	2.600,00
DC665-N20-E5	•		Copper Rame Matt DeNuance Ocean DeNuance Oceano opaco	N20	2.600,00
DC665-N30-E5	•		Copper Rame DeNuance Verdigris DeNuance Verderame	N30	2.680,00

Legs in brushed copper M10 / Gambe in rame spazzolato M10

DC665-N1-M10	•		Copper Rame DeNuance Forest DeNuance Foresta	N1	2.680,00
DC665-N2-M10	•		Copper Rame DeNuance Ocean DeNuance Oceano	N2	2.680,00
DC665-N10-M10	•		Copper Rame Matt DeNuance Forest DeNuance Foresta opaco	N10	2.680,00
DC665-N20-M10	•		Copper Rame Matt DeNuance Ocean DeNuance Oceano opaco	N20	2.680,00
DC665-N30-M10	•		Copper Rame DeNuance Verdigris DeNuance Verderame	N30	2.780,00

kg 11,5 kg

kg 22 kg

cm W. 61 D. 73 H. 75 cm

m³ 0,35 m³

NP 1

Excluding VAT
IVA esclusa

Flocks

DESIGN BY MATTEO ZORZENONI

Collection of coffee tables characterized by tops with rounded shapes characterised by different patterns in DeErosion technique and a cylindrical base.

Collezione di tavolini caratterizzati da piani dalle forme arrotondate caratterizzati da diversi pattern realizzati con la tecnica DeErosion e da una base cilindrica.

Flocks 45
DC730

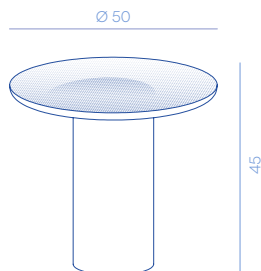

Flocks 38
DC732

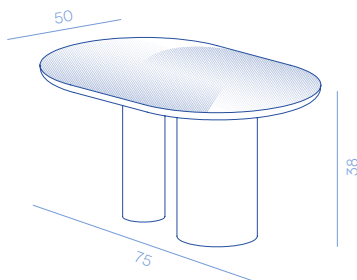

Flocks 32
DC731

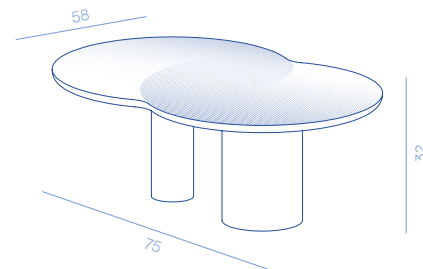

METAL FINISHES

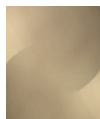

OT

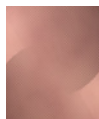

RA

PRODUCT SPECIFICATION

Base	DeLabré M12 
Assembly	Shipped assembled
Packaging	Wooden cage included TYPE C
Details	<ul style="list-style-type: none"> – Top characterized by a pattern in DeErosion technique – Wooden lacquered undertop – Cylindrical legs in metal

ON REQUEST

Finishes	The product is available only in the finishes listed
Dimensions	The product is available only in the dimensions listed

SPECIFICHE PRODOTTO

Base	DeLabré M12 
Assemblaggio	Spedito montato
Imballo	Imballo in gabbia di legno TIPO C
Dettagli	<ul style="list-style-type: none"> – Top caratterizzato dal pattern in DeErosion – Sottotop in legno laccato – Gambe cilindriche in metallo

SU RICHIESTA

Finiture	Il prodotto è disponibile solo nelle finiture previste
Dimensioni	Il prodotto è disponibile solo nelle dimensioni previste

FLOCKS 45

Ø. 50 H. 45 cm

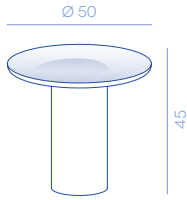

CODE / CODICE	IN	OUT	METAL FINISHES		EURO
DC730-OT	•		Brass Ottone	DeErosion DeErosion	2.200,00
DC730-RA	•		Copper Rame	DeErosion DeErosion	2.300,00

kg 25,5 kg
kg 30 kg
cm W. 69 D. 69 H. 73 cm
m³ 0,35 m³
Nº 1
Excluding VAT IVA esclusa

FLOCKS 38

W. 75 D. 50 H. 38 cm

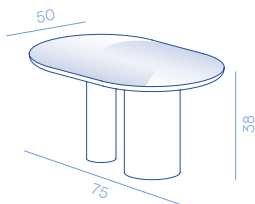

CODE / CODICE	IN	OUT	METAL FINISHES		EURO
DC732-OT	•		Brass Ottone	DeErosion DeErosion	2.690,00
DC732-RA	•		Copper Rame	DeErosion DeErosion	2.790,00

kg 30,5 kg
kg 40 kg
cm W. 94 D. 69 H. 66 cm
m³ 0,45 m³
Nº 1
Excluding VAT IVA esclusa

FLOCKS 32

W. 75 D. 58 H. 32 cm

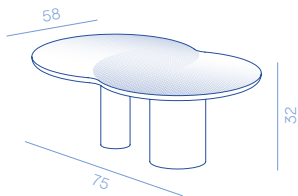

CODE / CODICE	IN	OUT	METAL FINISHES		EURO
DC731-OT	•		Brass Ottone	DeErosion DeErosion	2.780,00
DC731-RA	•		Copper Rame	DeErosion DeErosion	2.880,00

kg 34,5 kg
kg 42 kg
cm W. 109 D. 79 H. 63 cm
m³ 0,55 m³
Nº 1
Excluding VAT IVA esclusa

Nicola

DESIGN BY IVDESIGN

Collection of side tables entirely made of metal and characterized by a heavy cross-shaped base that balances the round top.

Collezione di tavolini interamente realizzati in metallo e caratterizzati da una pesante base a croce che bilancia il top rotondo.

Nicola 55
DC623

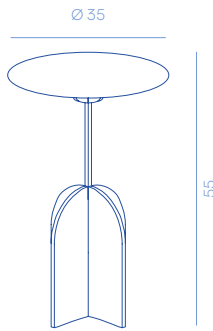

Nicola 50
DC624

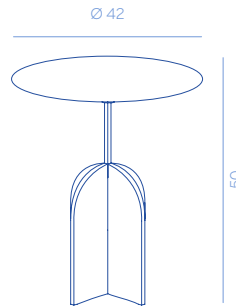

Nicola 45
DC625

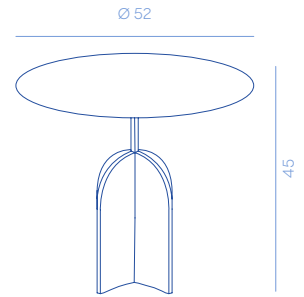

METAL FINISHES

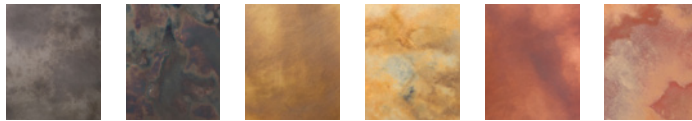

E1

M0

F2

M3

G5

M2

PRODUCT SPECIFICATION

Structure	DeLabré M12 
Assembly	Shipped assembled
Packaging	Carton box TYPE E
Details	<ul style="list-style-type: none">- Coffee tables entirely made of metal- Equipped with a ballast at the base to increase stability

SPECIFICHE PRODOTTO

Struttura	DeLabré M12 
Assemblaggio	Spedito montato
Imballo	Imballo in scatola di cartone TIPO E
Dettagli	<ul style="list-style-type: none">- Coffee Tables interamente in metallo- Base zavorrata per aumentare la stabilità

ON REQUEST

Finishes	<ul style="list-style-type: none">- The product can also be made in finishes on request, subject to confirmation of feasibility by De Castelli- Structure always in DeLabré iron M12- Price on request
Dimensions	The product is available only in the dimensions listed

SU RICHIESTA

Finiture	<ul style="list-style-type: none">- Il prodotto può essere realizzato anche in finiture su richiesta, previa conferma fattibilità da parte di De Castelli- Struttura sempre in ferro DeLabré M12- Prezzo su richiesta
Dimensioni	Il prodotto è disponibile solo nelle dimensioni previste

NICOLA 55

Ø. 35 H. 55 cm

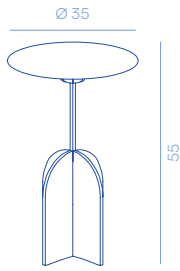

CODE / CODICE	IN	OUT	METAL FINISHES			EURO
DC623-E11	•		Stainless steel Acciaio inox	DeLabré DeLabré	E11	1.160,00
DC623-M0	•		Stainless steel Acciaio inox	DeOpale DeOpale	M0	1.280,00
DC623-F2	•		Brass Ottone	DeLabré DeLabré	F2	1.280,00
DC623-M3	•		Brass Ottone	DeOpale DeOpale	M3	1.380,00
DC623-G5	•		Copper Rame	DeLabré DeLabré	G5	1.430,00
DC623-M2	•		Copper Rame	DeOpale DeOpale	M2	1.480,00

kg 14 kg

kg 16 kg

cm W. 40 D. 40 H. 60 cm

m³ 0,10 m³

N° 1

Excluding VAT
IVA esclusa

NICOLA 50

Ø. 42 H. 50 cm

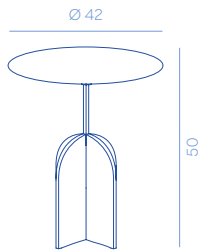

CODE / CODICE	IN	OUT	METAL FINISHES			EURO
DC624-E11	•		Stainless steel Acciaio inox	DeLabré DeLabré	E11	1.160,00
DC624-M0	•		Stainless steel Acciaio inox	DeOpale DeOpale	M0	1.280,00
DC624-F2	•		Brass Ottone	DeLabré DeLabré	F2	1.280,00
DC624-M3	•		Brass Ottone	DeOpale DeOpale	M3	1.380,00
DC624-G5	•		Copper Rame	DeLabré DeLabré	G5	1.430,00
DC624-M2	•		Copper Rame	DeOpale DeOpale	M2	1.480,00

kg 15 kg

kg 17 kg

cm W. 47 D. 47 H. 55 cm

m³ 0,12 m³

N° 1

Excluding VAT
IVA esclusa

NICOLA 45

Ø. 52 H. 45 cm

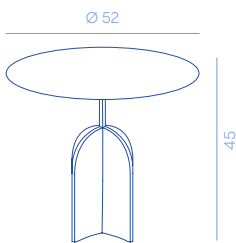

CODE / CODICE	IN	OUT	METAL FINISHES			EURO
DC625-E11	•		Stainless steel Acciaio inox	DeLabré DeLabré	E11	1.230,00
DC625-M0	•		Stainless steel Acciaio inox	DeOpale DeOpale	M0	1.350,00
DC625-F2	•		Brass Ottone	DeLabré DeLabré	F2	1.350,00
DC625-M3	•		Brass Ottone	DeOpale DeOpale	M3	1.450,00
DC625-G5	•		Copper Rame	DeLabré DeLabré	G5	1.500,00
DC625-M2	•		Copper Rame	DeOpale DeOpale	M2	1.550,00

kg 18,5 kg

kg 20 kg

cm W. 57 D. 57 H. 50 cm

m³ 0,28 m³

N° 1

Excluding VAT
IVA esclusa

Parsec

DESIGN BY EMILIO NANNI

Collection of coffee table with round top and tubular base, with or without the central metal bowl.
Collezione di tavolini con piano rotondo e base in tubolare, con o senza ciotola centrale in metallo.

Version without bowl / Versione senza ciotola

Parsec 98
DC621

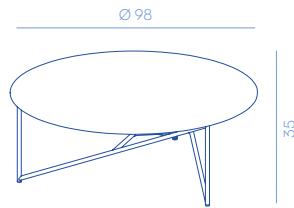

Parsec 120
DC622

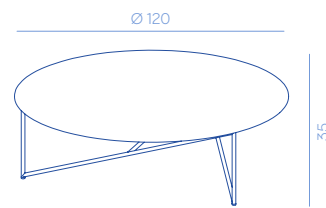

Version with bowl ø 30 cm / Versione con ciotola ø 30 cm

Parsec 98 bowl
DC621V

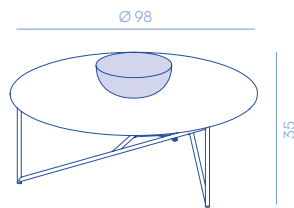

Parsec 120 bowl
DC622V

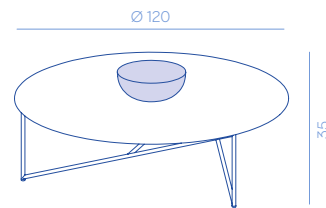

METAL FINISHES



E11

M0

F2

M3

G5

M2

PRODUCT SPECIFICATION

Structure	DeLabré M12 
Assembly	Shipped assembled
Packaging	Carton box TYPE E
Details	<ul style="list-style-type: none"> - Coffee tables entirely made of metal - The bowl, if ordered, is fixed and not removable - They feature a rods structure

SPECIFICHE PRODOTTO

Struttura	DeLabré M12 
Assemblaggio	Spedito montato
Imballo	Imballo in scatola di cartone TIPO E
Dettagli	<ul style="list-style-type: none"> - Tavolini interamente in metallo - La ciotola, se ordinata, viene fissata e non è rimovibile - Caratterizzati da struttura in tondini

ON REQUEST

Finishes	<ul style="list-style-type: none"> - The product can also be made in finishes on request, subject to confirmation of feasibility by De Castelli - Structure always in DeLabré iron - Price on request
Dimensions	The product is available only in the dimensions listed

SU RICHIESTA

Finiture	<ul style="list-style-type: none"> - Il prodotto può essere realizzato anche in finiture su richiesta, previa conferma fattibilità da parte di De Castelli - Struttura sempre in ferro DeLabré - Prezzo su richiesta
Dimensioni	Il prodotto è disponibile solo nelle dimensioni previste

PARSEC 98

Ø. 98 H. 35 cm

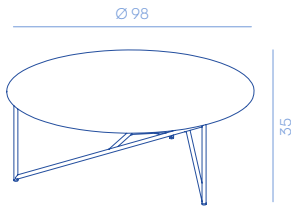

CODE / CODICE	IN	OUT	METAL FINISHES			EURO
DC621-E11	•		Stainless steel Acciaio inox	DeLabré DeLabré	E11	2.340,00
DC621-M0	•		Stainless steel Acciaio inox	DeOpale DeOpale	M0	2.430,00
DC621-F2	•		Brass Ottone	DeLabré DeLabré	F2	2.800,00
DC621-M3	•		Brass Ottone	DeOpale DeOpale	M3	2.800,00
DC621-G5	•		Copper Rame	DeLabré DeLabré	G5	3.300,00
DC621-M2	•		Copper Rame	DeOpale DeOpale	M2	3.300,00

kg 30 kg
kg 32,5 kg
cm W. 100 D. 100 H. 52 cm
m³ 0,52 m³
N° 1
Excluding VAT IVA esclusa

PARSEC 120

Ø. 120 H. 35 cm

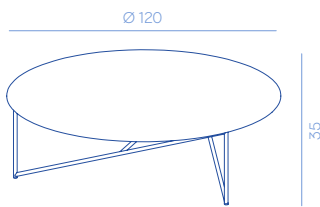

CODE / CODICE	IN	OUT	METAL FINISHES			EURO
DC622-E11	•		Stainless steel Acciaio inox	DeLabré DeLabré	E11	2.500,00
DC622-M0	•		Stainless steel Acciaio inox	DeOpale DeOpale	M0	2.650,00
DC622-F2	•		Brass Ottone	DeLabré DeLabré	F2	3.400,00
DC622-M3	•		Brass Ottone	DeOpale DeOpale	M3	3.400,00

kg 41 kg
kg 43 kg
cm W. 130 D. 130 H. 52 cm
m³ 0,90 m³
N° 1
Excluding VAT IVA esclusa

PARSEC 98 BOWL

Ø. 98 H. 35 cm

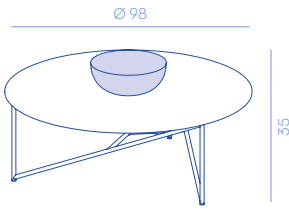

CODE / CODICE	IN	OUT	METAL FINISHES			EURO
DC621V-E11	•		Stainless steel Acciaio inox	DeLabré DeLabré	E11	2.490,00
DC621V-M0	•		Stainless steel Acciaio inox	DeOpale DeOpale	M0	2.580,00
DC621V-F2	•		Brass Ottone	DeLabré DeLabré	F2	2.950,00
DC621V-M3	•		Brass Ottone	DeOpale DeOpale	M3	2.950,00
DC621V-G5	•		Copper Rame	DeLabré DeLabré	G5	3.450,00
DC621V-M2	•		Copper Rame	DeOpale DeOpale	M2	3.450,00

kg 30 kg
kg 32,5 kg
cm W. 100 D. 100 H. 52 cm
m³ 0,52 m³
N° 1
Excluding VAT
IVA esclusa

PARSEC 120 BOWL

Ø. 120 H. 35 cm

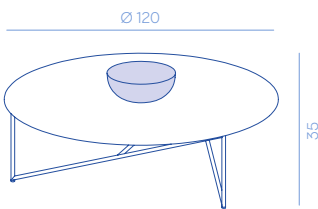

CODE / CODICE	IN	OUT	METAL FINISHES			EURO
DC622-E11	•		Stainless steel Acciaio inox	DeLabré DeLabré	E11	2.650,00
DC622-M0	•		Stainless steel Acciaio inox	DeOpale DeOpale	M0	2.800,00
DC622-F2	•		Brass Ottone	DeLabré DeLabré	F2	3.500,00
DC622-M3	•		Brass Ottone	DeOpale DeOpale	M3	3.500,00

kg 41 kg
kg 43 kg
cm W. 130 D. 130 H. 52 cm
m³ 0,90 m³
N° 1
Excluding VAT
IVA esclusa

Placas

DESIGN BY LUCIDIPEVERE

Collection of side tables entirely made of metal characterised by a petal-like top and cast brass or copper feet.

Collezione di tavolini interamente realizzati in metallo caratterizzati da un piano a forma di petalo e piedini in fusione di ottone o rame.

Placas 60
DC491

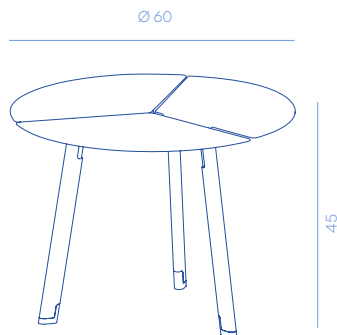

Placas 100
DC490

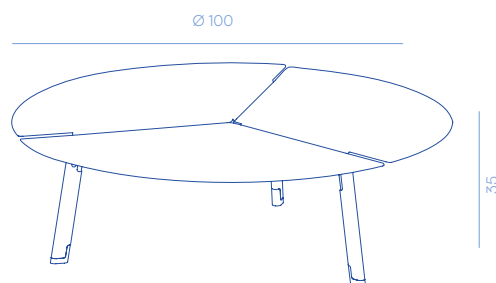

METAL FINISHES

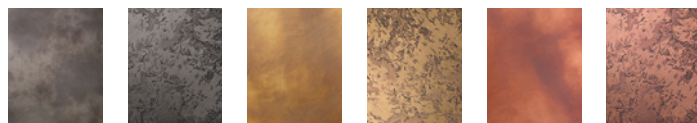

E11

H8

F2

H8

G5

H8

PRODUCT SPECIFICATION

Structure
Legs
Feets

DeLabré M12
Cast brass / cast brass with copper finishing



Assembly Shipped assembled

Packaging Carton box **TYPE E**

Details

- Coffee tables entirely made of metal
- The top consists on three petal-like pieces
- Brass cast feet for coffee tables with top in brass and stainless steel finishes
- Copper cast feet for coffee tables with top in copper finishes

ON REQUEST

Finishes

- The product can also be made in finishes on request, subject to confirmation of feasibility by De Castelli
- Structure always in DeLabré iron, feet always in cast brass
- Price on request

Dimensions The product is available only in the dimensions listed

SPECIFICHE PRODOTTO

Struttura
Gambe
Piedini

DeLabré M12
Fusione in ottone / fusione in ottone con finitura rame



Assemblaggio Spedito montato

Imballo Imballo in scatola di cartone **TIPO E**

Dettagli

- Tavolini realizzati interamente in metallo
- Il top consiste in tre pezzi a forma di petalo
- Piedini in fusione di ottone per tavolini con piano nelle finiture ottone e acciaio inox
- Piedini in fusione di rame per tavolini con piano in finiture rame

SU RICHIESTA

Finiture

- Il prodotto può essere realizzato anche in finiture su richiesta, previa conferma fattibilità da parte di De Castelli
- Struttura sempre in ferro DeLabré, piedini sempre in fusione di ottone
- Prezzo su richiesta

Dimensioni Il prodotto è disponibile solo nelle dimensioni previste

PLACAS 60

Ø. 60 H. 45 cm

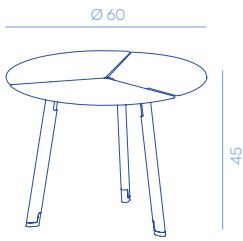

CODE / CODICE	IN	OUT	METAL FINISHES			EURO
DC491-E11	•		Stainless steel Acciaio inox	DeLabré DeLabré	E11	1.270,00
DC491-IX-H8	•		Stainless steel Acciaio inox	DeErosion DeErosion	H8	1.470,00
DC491-F2	•		Brass Ottone	DeLabré DeLabré	F2	1.550,00
DC491-OT-H8	•		Brass Ottone	DeErosion DeErosion	H8	1.750,00
DC491-G5	•		Copper Rame	DeLabré DeLabré	G5	1.900,00
DC491-RA-H8	•		Copper Rame	DeErosion DeErosion	H8	2.100,00

kg 11 kg
kg 12,5 kg
cm < W. 65 D. 65 H. 50 cm
m² 0,30 m²
Nº 1
Excluding VAT IVA esclusa

PLACAS 100

Ø. 100 H. 35 cm

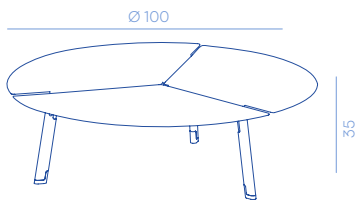

CODE / CODICE	IN	OUT	METAL FINISHES			EURO
DC490-E11	•		Stainless steel Acciaio inox	DeLabré DeLabré	E11	1.800,00
DC490-IX-H8	•		Stainless steel Acciaio inox	DeErosion DeErosion	H8	2.000,00
DC490-F2	•		Brass Ottone	DeLabré DeLabré	F2	2.530,00
DC490-OT-H8	•		Brass Ottone	DeErosion DeErosion	H8	2.800,00
DC490-G5	•		Copper Rame	DeLabré DeLabré	G5	3.570,00
DC490-RA-H8	•		Copper Rame	DeErosion DeErosion	H8	3.800,00

kg 24 kg
kg 26 kg
cm < W. 105 D. 105 H. 35 cm
m² 0,45 m²
Nº 1
Excluding VAT IVA esclusa

Scribble

DESIGN BY FRANCESCA LANZAVECCHIA

Collection of side tables entirely made of metal, characterised by the sinuous shapes of the tops and a tubular metal base.

Collezione di tavolini interamente realizzati in metallo, caratterizzati dalle forme sinuose dei piani e da una base in tubolare di metallo.

Dot
DC544-M3

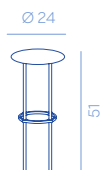

Comma
DC546-G1

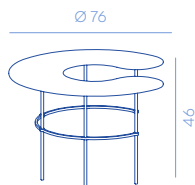

Bracket
DC549-G7

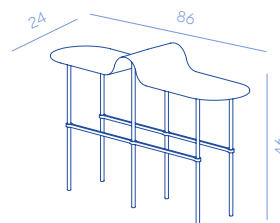

Parenthesis
DC545-F7

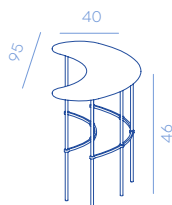

Tilde
DC548-G11

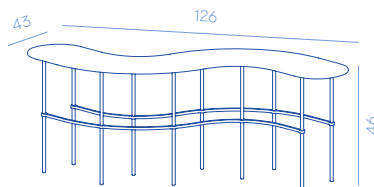

Accent
DC547-G3

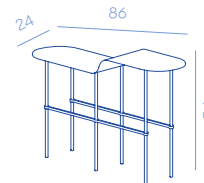

METAL FINISHES



G1

M3

G3

G7

F7

G11

PRODUCT SPECIFICATION

Legs DeLabré M12



Assembly Shipped assembled

Packaging Carton box [TYPE E](#)

Details – Coffee tables entirely made of metal

SPECIFICHE PRODOTTO

Gambe DeLabré M12



Assemblaggio Spedito montato

Imballo Imballo in scatola di cartone [TIPO E](#)

Dettagli – Tavolini interamente in metallo

ON REQUEST

Finishes The product is available only in the finishes listed

Dimensions The product is available only in the dimensions listed

SU RICHIESTA

Finiture Il prodotto è disponibile solo nelle finiture previste

Dimensioni Il prodotto è disponibile solo nelle dimensioni previste

DOT

Ø. 24 H. 51 cm

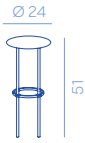

CODE / CODICE	IN	OUT	METAL FINISHES		EURO
DC544-M3	•		Brass Ottone	DeOpale DeOpale	M3 950,00

kg 2,8 kg
 kg 5 kg
 cm W. 30 D. 30 H. 56 cm
 m³ 0,05 m³
 N° 1
 Excluding VAT
IVA esclusa

COMMA

Ø. 76 H. 46 cm

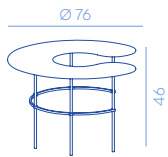

CODE / CODICE	IN	OUT	METAL FINISHES		EURO
DC546-G1	•		Black iron Lamiera nera	DeLabré DeLabré	G1 1.250,00

kg 15,5 kg
 kg 16 kg
 cm W. 81 D. 81 H. 51 cm
 m³ 0,35 m³
 N° 1
 Excluding VAT
IVA esclusa

BRACKET

W. 86 D. 24 H. 46 cm

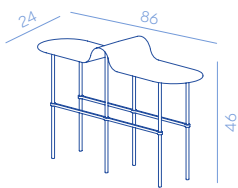

CODE / CODICE	IN	OUT	METAL FINISHES		EURO
DC549-G7	•		Brass Ottone	Striped DeLabré DeLabré Striato	G7 1.650,00

kg 9,6 kg
 kg 11 kg
 cm W. 91 D. 30 H. 51 cm
 m³ 0,15 m³
 N° 1
 Excluding VAT
IVA esclusa

PARENTHESIS

W.95 D. 40 H. 46 cm

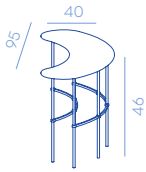

CODE / CODICE	IN	OUT	METAL FINISHES			EURO
DC545-F7	•		Copper Rame	Verdigris Verderame	F7	2.150,00

kg 13 kg
 kg 14,5 kg
 cm W. 100 D. 45 H. 51 cm
 m³ 0,23 m³
 Nº 1
 Excluding VAT
IVA esclusa

TILDE

W. 126 D. 43 H. 46 cm

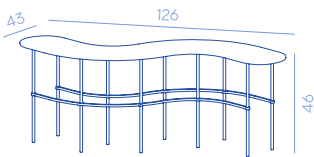

CODE / CODICE	IN	OUT	METAL FINISHES			EURO
DC548-G11	•		Copper Rame	Rubin Rubino	G11	1.800,00

kg 16,6 kg
 kg 17,5 kg
 cm W. 131 D. 50 H. 51 cm
 m³ 0,35 m³
 Nº 1
 Excluding VAT
IVA esclusa

ACCENT

W.86 D. 24 H. 54 cm

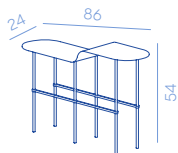

CODE / CODICE	IN	OUT	METAL FINISHES			EURO
DC547-G3	•		Brass Ottone	Orbitale DeLabré DeLabré Orbitale	G3	1.450,00

kg 10 kg
 kg 12 kg
 cm W. 91 D. 30 H. 60 cm
 m³ 0,16 m³
 Nº 1
 Excluding VAT
IVA esclusa

Sunrise & Sunset

DESIGN BY ARTEFATTO

Collection of round side tables with tray-like tops and conical base supplied with ballast to ensure stability.
Collezione di tavolini rotondi con piani a vassoio e base conica dotati di zavorra per garantirne la stabilità.

Sunrise
DC535

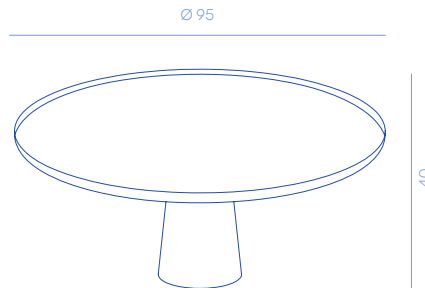

Sunset
DC536

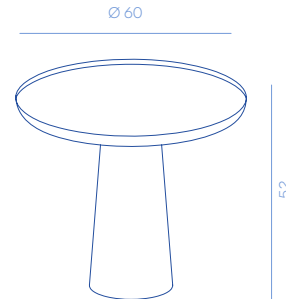

METAL FINISHES

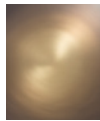

OT

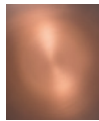

RA

PRODUCT SPECIFICATION

Base	DeLabré M12 
Assembly	Shipped assembled
Packaging	Wooden cage included TIPO C
Details	<ul style="list-style-type: none">- Coffee tables entirely made of metal- They feature a tray-like top and a conical base supplied with ballast to ensure stability

SPECIFICHE PRODOTTO

Base	DeLabré M12 
Assemblaggio	Spedito montato
Imballo	Imballo in gabbia di legno incluso TIPO C
Dettagli	<ul style="list-style-type: none">- Coffee tables interamente in metallo- Caratterizzati da un top a vassoio e una base conica zavorrata per aumentare la stabilità

ON REQUEST

Finishes	<ul style="list-style-type: none">- The product can also be made in finishes on request, subject to confirmation of feasibility by De Castelli- Structure always in DeLabré stainless steel M12- Price on request
Dimensions	The product is available only in the dimensions listed

SU RICHIESTA

Finiture	<ul style="list-style-type: none">- Il prodotto può essere realizzato anche in finiture su richiesta, previa conferma fattibilità da parte di De Castelli- Struttura sempre in acciaio inox DeLabré M12- Prezzo su richiesta
Dimensioni	Il prodotto è disponibile solo nelle dimensioni previste

Syro

DESIGN BY EMILIO NANNI

Collection of side tables entirely made of metal characterised by irregularly-shaped eroded tops.

Collezione di tavolini interamente realizzati in metallo caratterizzati da piani erosi dalla forma irregolare.

Syro 45
DC511

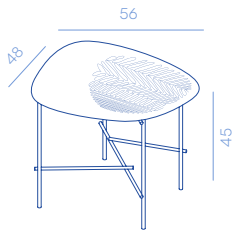

Syro 37
DC512

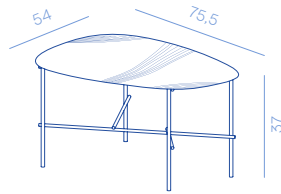

Syro 30
DC513

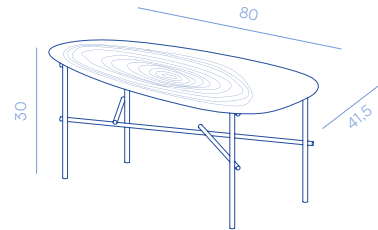

METAL FINISHES



E5

G2

F2

G3

G5

G4

PRODUCT SPECIFICATION

Structure	DeLabré M12 
Assembly	Shipped assembled
Packaging	Carton box TYPE E
Details	<ul style="list-style-type: none"> - Coffee tables entirely made of metal - They feature an irregularly-shaped engraved top and a rods structure

SPECIFICHE PRODOTTO

Struttura	DeLabré M12 
Assemblaggio	Spedito montato
Imballo	Imballo in scatola di cartone TIPO E
Dettagli	<ul style="list-style-type: none"> - Tavolini interamente realizzati in metallo - Caratterizzati da un top inciso dalla forma irregolare e struttura in tondini

ON REQUEST

Finishes	The product is available only in the finishes listed
Dimensions	The product is available only in the dimensions listed

SU RICHIESTA

Finiture	Il prodotto è disponibile solo nelle finiture previste
Dimensioni	Il prodotto è disponibile solo nelle dimensioni previste

SYRO 45

W. 56 D. 48 H. 45 cm

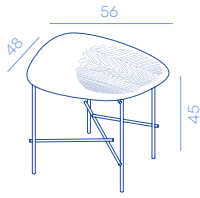

CODE / CODICE	IN	OUT	METAL FINISHES			EURO
DC511-E5	•		Stainless steel Acciaio inox	DeLabré B DeLabré B	E5	1.400,00
DC511-G2	•		Stainless steel Acciaio inox	Orbitale DeLabré DeLabré Orbitale	G2	1.500,00
DC511-F2	•		Brass Ottone	DeLabré DeLabré	F2	1.630,00
DC511-G3	•		Brass Ottone	Orbitale DeLabré DeLabré Orbitale	G3	1.700,00
DC511-G5	•		Copper Rame	DeLabré DeLabré	G5	1.850,00
DC511-G4	•		Copper Rame	Orbitale DeLabré DeLabré Orbitale	G4	1.900,00

kg 10 kg

kg 11 kg

cm W. 61 D. 52 H. 50 cm

m³ 0,15 m³

Nº 1

Excluding VAT
IVA esclusa

SYRO 37

W. 75,5 D. 54 H. 37 cm

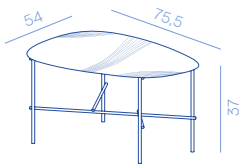

CODE / CODICE	IN	OUT	METAL FINISHES			EURO
DC512-E5	•		Stainless steel Acciaio inox	DeLabré B DeLabré B	E5	1.300,00
DC512-G2	•		Stainless steel Acciaio inox	Orbitale DeLabré DeLabré Orbitale	G2	1.400,00
DC512-F2	•		Brass Ottone	DeLabré DeLabré	F2	1.560,00
DC512-G3	•		Brass Ottone	Orbitale DeLabré DeLabré Orbitale	G3	1.680,00
DC512-G5	•		Copper Rame	DeLabré DeLabré	G5	1.850,00
DC512-G4	•		Copper Rame	Orbitale DeLabré DeLabré Orbitale	G4	1.900,00

kg 13,5 kg

kg 14,5 kg

cm W. 60 D. 80 H. 42 cm

m³ 0,20 m³

Nº 1

Excluding VAT
IVA esclusa

SYRO 30

W. 80 D. 41,5 H. 30 cm

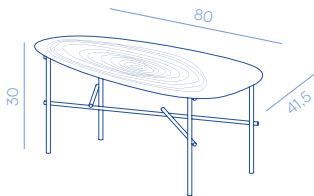

CODE / CODICE	IN	OUT	METAL FINISHES			EURO
DC513-E5	•		Stainless steel Acciaio inox	DeLabré B DeLabré B	E5	1.200,00
DC513-G2	•		Stainless steel Acciaio inox	Orbitale DeLabré DeLabré Orbitale	G2	1.300,00
DC513-F2	•		Brass Ottone	DeLabré DeLabré	F2	1.530,00
DC513-G3	•		Brass Ottone	Orbitale DeLabré DeLabré Orbitale	G3	1.600,00
DC513-G5	•		Copper Rame	DeLabré DeLabré	G5	1.750,00
DC513-G4	•		Copper Rame	Orbitale DeLabré DeLabré Orbitale	G4	1.800,00

kg 11 kg

kg 12 kg

cm W. 85 D. 46 H. 35 cm

m³ 0,15 m³

Nº 1

Excluding VAT
IVA esclusa

Syro XL

DESIGN BY EMILIO NANNI

Collection of side tables entirely made of metal with large irregularly-shaped tops characterized by DeErosion finishes.

Collezione di tavolini interamente realizzati in metallo con piani ampi dalla forma irregolare caratterizzati dalle finiture DeErosion.

Syro XL 88
DC630

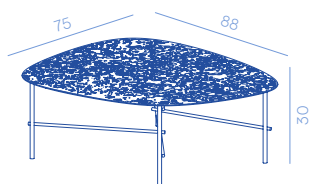

Syro XL 98
DC631

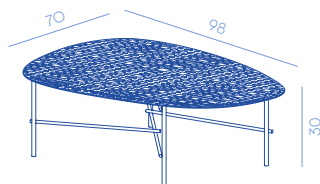

Syro XL 120
DC632

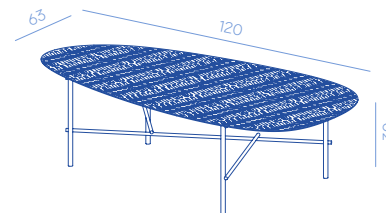

METAL FINISHES



PRODUCT SPECIFICATION

Structure	DeLabré M12 
Assembly	Shipped assembled
Packaging	Carton box TYPE E
Details	<ul style="list-style-type: none"> - Coffee tables entirely made of metal - They feature a top in DeErosion finishing and a metal rods structure

SPECIFICHE PRODOTTO

Struttura	DeLabré M12 
Assemblaggio	Spedizione del prodotto montato
Imballo	Imballo in scatola di cartone TIPO E
Dettagli	<ul style="list-style-type: none"> - Coffee tables interamente in metallo - Caratterizzati dal top in finitura DeErosion e dalla struttura in tondini di metallo

ON REQUEST

Finishes	The product is available only in the finishes listed
Dimensions	The product is available only in the dimensions listed

SU RICHIESTA

Finiture	Il prodotto è disponibile solo nelle finiture previste
Dimensioni	Il prodotto è disponibile solo nelle dimensioni previste

SYRO XL 88

W. 88 D. 75 H.30 cm

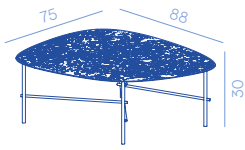

CODE / CODICE	IN	OUT	METAL FINISHES			EURO
DC630-OT-H7	•		Brass Ottone	DeErosion DeErosion	H7	2.400,00
DC630-RA-H7	•		Copper Rame	DeErosion DeErosion	H7	2.700,00

kg 24,5 kg
 kg 26 kg
 cm W. 80 D. 93 H. 35 cm
 m² 0,26 m²
 N° 1
 Excluding VAT IVA esclusa

SYRO XL 98

W. 98 D. 72 H. 30 cm

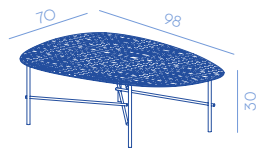

CODE / CODICE	IN	OUT	METAL FINISHES			EURO
DC631-OT-H6	•		Brass Ottone	DeErosion DeErosion	H6	2.600,00
DC631-RA-H6	•		Copper Rame	DeErosion DeErosion	H6	2.850,00

kg 26 kg
 kg 32 kg
 cm W. 75 D. 103 H. 35 cm
 m² 0,27 m²
 N° 1
 Excluding VAT IVA esclusa

SYRO XL 120

W. 120 D. 63 H. 30 cm

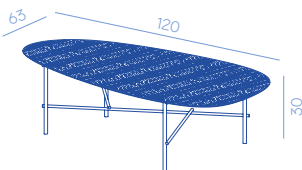

CODE / CODICE	IN	OUT	METAL FINISHES			EURO
DC632-IX-H3	•		Stainless steel Acciaio inox	DeErosion DeErosion	H3	2.000,00
DC632-OT-H3	•		Brass Ottone	DeErosion DeErosion	H3	2.800,00
DC632-RA-H3	•		Copper Rame	DeErosion DeErosion	H3	3.000,00

kg 25,5 kg
 kg 27 kg
 cm W. 125 D. 68 H. 35 cm
 m² 0,30 m²
 N° 1
 Excluding VAT IVA esclusa

Xilo Coffee table

DESIGN BY DELINEO DESIGN STUDIO

Sculptural coffee table entirely made of 3 mm thick brass metal sheets rounded at the ends.

Tavolino scultoreo realizzato interamente in lastre di ottone in spessore 3 mm stondate alle estremità.

Xilo Table
DC697

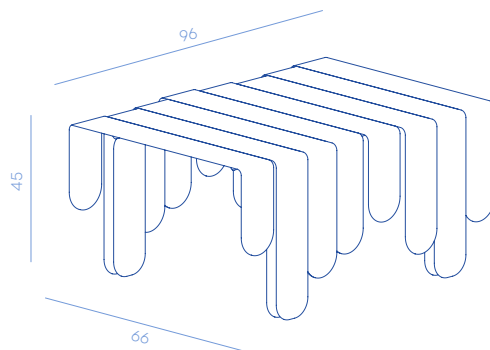

METAL FINISHES



L1



L2

PRODUCT SPECIFICATION

Assembly	Shipped assembled
Packaging	Wooden cage included TYPE C
Details	– Sculptural coffee table entirely made of 3 mm thick brass

SPECIFICHE PRODOTTO

Assemblaggio	Spedito montato
Imballo	Imballo in gabbia di legno incluso TIPO C
Dettagli	– Coffee table scultoreo interamente realizzato in ottone di spessore 3 mm

ON REQUEST

Finishes	The product is available only in the finishes listed
Dimensions	The product is available only in the dimensions listed

SU RICHIESTA

Finiture	Il prodotto è disponibile solo nelle finiture previste
Dimensioni	Il prodotto è disponibile solo nelle dimensioni previste

XILO

W. 96 D. 66 H. 45 cm

CODE / CODICE	IN	OUT	METAL FINISHES			EURO
DC697-L1	•		Brass Ottone	DeGlyphé DeGlyphé	L1	8.400,00
DC697-L2	•		Brass Ottone	DeGlyphé DeGlyphé	L2	8.400,00

 48 kg

 68 kg

 W. 115 D. 85 H. 73 cm

 0,71 m³

 1

Excluding VAT
IVA esclusa

Dividers
Divisori

Monolite

DESIGN BY TIPSTUDIO

Self-standing divider with integrated light on both sides entirely made of metal.

Divisorio self-standing con luce integrata su entrambi i lati realizzato interamente in metallo.

Monolite
DC694

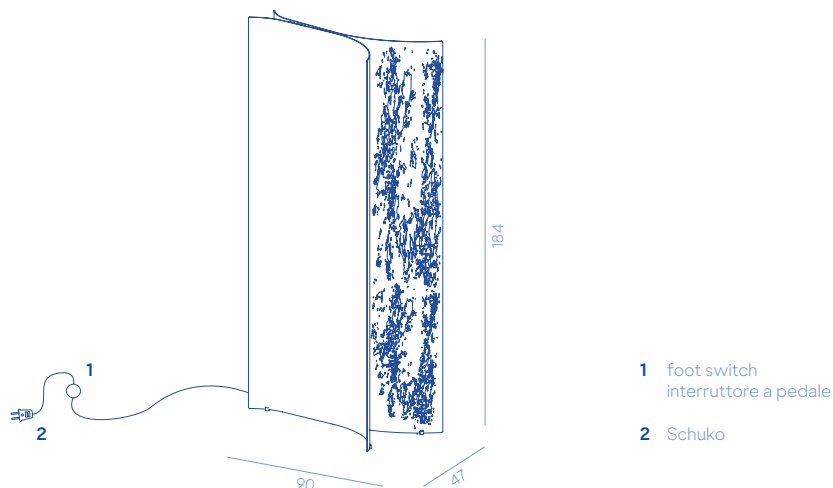

Lighting details / Dettagli illuminazione

VOLTAGE V	FREQ. HZ	POWER W	CLASS	IP	TEMP K°	DIMMABLE
230 V	50/60 HZ	42 W	I	20	3000°	YES

METAL FINISHES

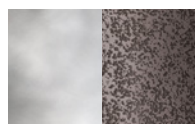

M11+IX-H11

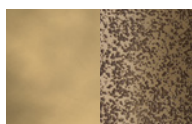

M9+OT-H11

PRODUCT SPECIFICATION

Assembly	Shipped assembled
Packaging	Wooden crate included TYPE A
Details	<ul style="list-style-type: none">– Integrated dimmable 3000 K LED light on both sides included– Foot switch and Schuko plug– Feet support included

ON REQUEST

Finishes	<ul style="list-style-type: none">– The product can also be made upon request, subject to confirmation of feasibility by De Castelli– Price on request
Dimensions	The product is available only in the dimensions listed

SPECIFICHE PRODOTTO

Assemblaggio	Spedito montato
Imballo	Imballo in cassa incluso TIPO A
Dettagli	<ul style="list-style-type: none">– Luce LED 3000 K dimmerabile integrata su entrambi i lati inclusa– Interruttore a pedale e spina Schuko– Supporto per i piedi incluso

SU RICHIESTA

Finiture	<ul style="list-style-type: none">– Il prodotto può essere realizzato anche in finiture su richiesta, previa conferma fattibilità da parte di De Castelli– Prezzo su richiesta
Dimensioni	Il prodotto è disponibile solo nelle dimensioni previste

MONOLITE

W. 90 D. 47 H. 184 cm

CODE / CODICE	IN	OUT	METAL FINISHES			EURO
DC694-IX-H11	•		Stainless steel Acciaio inox	DeErosion H11 DeErosion H11	H11	11.700,00
DC694-OT-H11	•		Brass Ottone	DeErosion H11 DeErosion H11	H11	13.400,00

 95 kg

 117 kg

 W. 104 D. 198 H. 117 cm

 2,26 m²

 1

Excluding VAT
IVA esclusa

Painting

DESIGN BY ALESSANDRA BALDERESCHI

Self-standing divider clad on both sides with different metals and finishes composing a daytime hilly scenery on one side and a nocturnal one on the other.

Divisorio self-standing rivestito su entrambi i lati con metalli e finiture diverse a comporre uno scenario collinare diurno da un lato e notturno dall'altro.

Painting
DC540

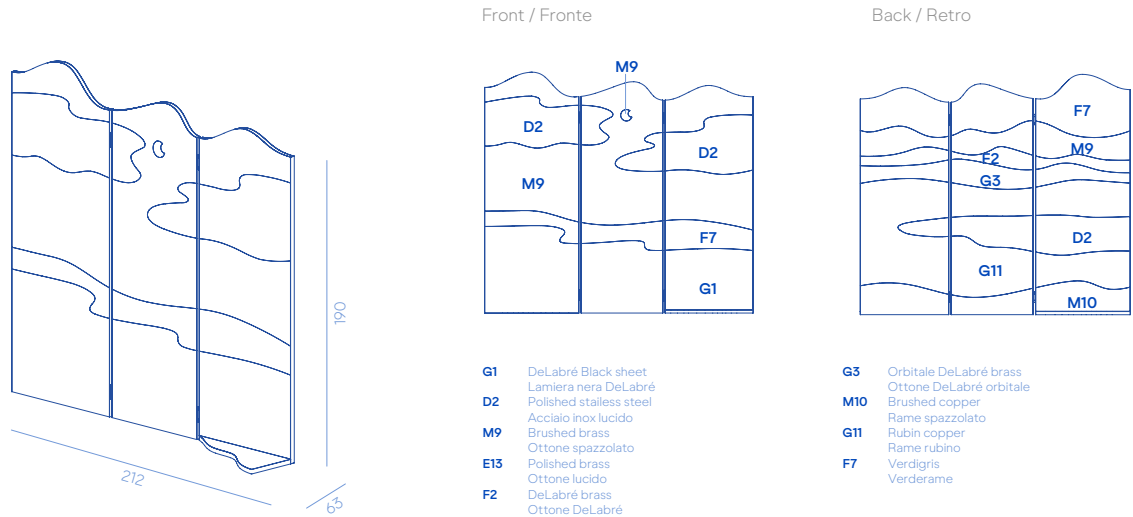

METAL FINISHES

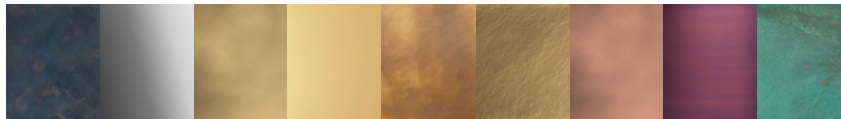

MIX G1 D2 M9 E13 F2 G3 M10 G11 F7

PRODUCT SPECIFICATION

Assembly	Shipped disassembled
Packaging	Wooden crate included TYPE A
Details	<ul style="list-style-type: none"> – Self-standing divider clad in metal on both sides – Materials and finishes as per drawing and related legend

SPECIFICHE PRODOTTO

Assemblaggio	Spedito smontato
Imballo	Imballo in cassa incluso TIPO A
Dettagli	<ul style="list-style-type: none"> – Divisorio autoportante rivestito in metallo su entrambi i lati – Materiali e finiture come da disegno e relativa legenda

ON REQUEST

Finishes	The product is available only in the finishes listed
Dimensions	The product is available only in the dimensions listed

SU RICHIESTA

Finiture	Il prodotto è disponibile nelle sole finiture previste
Dimensioni	Il prodotto è disponibile solo nelle dimensioni previste

PAINTING

W. 212 D. 63 H. 190 cm

CODE / CODICE	IN	OUT	METAL FINISHES	EURO
DC540	•		Materials and finishes as per drawings and legend Materiali e finiture come da disegno e legenda	16.700,00

 125 kg

 145 kg

 W. 209 D. 94 H. 75 cm

 1,50 m³

 1

Excluding VAT
IVA esclusa

Lightings
Luci

Aare Ceiling

DESIGN BY ALEXANDER PURCELL RODRIGUES

Decorative pendant lamp characterized by two elements made of metal and bidirectional light.

Lampada decorativa a sospensione caratterizzata da due elementi realizzati in metallo e luce bidirezionale.

Aare ceiling 120
DC720

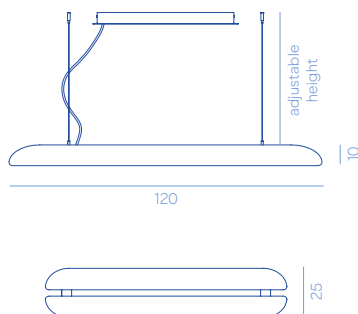

Aare ceiling 180
DC721

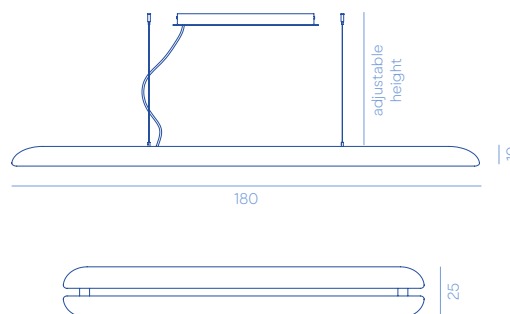

Lighting details / Dettagli illuminazione

CODE / CODICE	VOLTAGE V	FREQ. HZ	POWER W	CLASS	IP	TEMP K°	DIMMABLE
DC720	100-240V	50/60 HZ	55 W	I	20	3000°	YES - DALI
DC721	100-240V	50/60 HZ	90 W	I	20	3000°	YES - DALI

METAL FINISHES

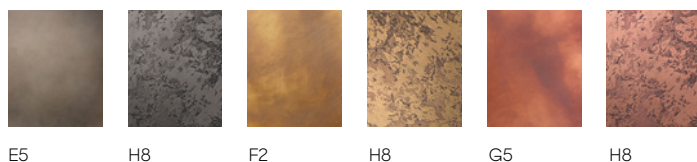

PRODUCT SPECIFICATION

Assembly	Shipped disassembled
Packaging	Wooden cage included TYPE C
Details	<ul style="list-style-type: none"> - Suspended lamp characterized by two metal elements - Supplied with a 3 m power cable and a 3 m steel fixing ropes - Adjustable suspension ropes - Ceiling fixing system included, fixing screws excluded

ON REQUEST

Finishes	<ul style="list-style-type: none"> - The product can also be made upon request, subject to confirmation of feasibility by De Castelli - Price on request
Dimensions	The product is available only in the dimensions listed

SPECIFICHE PRODOTTO

Assemblaggio	Spedito smontato
Imballo	Imballo in gabbia di legno incluso TIPO C
Dettagli	<ul style="list-style-type: none"> - Lampada a sospensione caratterizzata da due elementi in metallo - Fornita con cavo di alimentazione da 3 m e cavo di fissaggio in acciaio da 3 m - Cavi di fissaggio regolabili - Sistema di fissaggio a soffitto incluso, viti di fissaggio escluse

SU RICHIESTA

Finiture	<ul style="list-style-type: none"> - Il prodotto può essere realizzato anche in finiture su richiesta, previa conferma fattibilità da parte di De Castelli - Prezzo su richiesta
Dimensioni	Il prodotto è disponibile solo nelle dimensioni previste

AARE CEILING 120

W. 120 D. 25 H. 10 cm

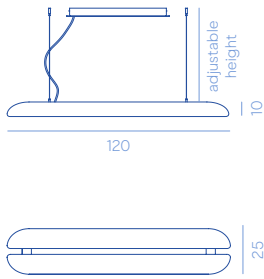

CODE / CODICE	IN	OUT	METAL FINISHES			EURO
DC720-E5	•		Stainless steel Acciaio inox	DeLabré B DeLabré B	E5	2.450,00
DC720-IX-H8	•		Stainless steel Acciaio inox	DeErosion DeErosion	H8	2.600,00
DC720-F2	•		Brass Ottone	DeLabré DeLabré	F2	2.700,00
DC720-OT-H8	•		Brass Ottone	DeErosion DeErosion	H8	2.800,00
DC720-L3	•		Brass Ottone	DeGlyphé gamma DeGlyphé gamma	L3	2.880,00
DC720-L5	•		Brass Ottone	DeGlyphé epsilon DeGlyphé epsilon	L5	2.880,00
DC720-G5	•		Copper Rame	DeLabré DeLabré	G5	2.830,00
DC720-RA-H8	•		Copper Rame	DeErosion DeErosion	H8	2.950,00

kg 15 kg

kg 30 kg

cm W. 80 D. 130 H. 60 cm

m³ 0,62 m³

N° 1

Excluding VAT
IVA esclusa

AARE CEILING 180

W. 180 D. 25 H. 10 cm

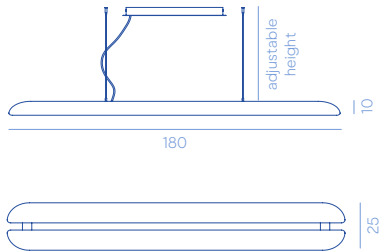

CODE / CODICE	IN	OUT	METAL FINISHES			EURO
DC721-E5	•		Stainless steel Acciaio inox	DeLabré B DeLabré B	E5	3.700,00
DC721-IX-H8	•		Stainless steel Acciaio inox	DeErosion DeErosion	H8	3.850,00
DC721-F2	•		Brass Ottone	DeLabré DeLabré	F2	3.930,00
DC721-OT-H8	•		Brass Ottone	DeErosion DeErosion	H8	4.200,00
DC721-L3	•		Brass Ottone	DeGlyphé gamma DeGlyphé gamma	L3	4.250,00
DC721-L5	•		Brass Ottone	DeGlyphé epsilon DeGlyphé epsilon	L5	4.250,00
DC721-G5	•		Copper Rame	DeLabré DeLabré	G5	4.300,00
DC721-RA-H8	•		Copper Rame	DeErosion DeErosion	H8	4.400,00

kg 23 kg

kg 35 kg

cm W. 80 D. 190 H. 60 cm

m³ 0,91 m³

N° 1

Excluding VAT
IVA esclusa

Aare Wall

DESIGN BY ALEXANDER PURCELL RODRIGUES

Decorative sconce characterized by two frontal elements made of metal.

Applique decorativa caratterizzata da due elementi frontali realizzati in metallo.

Aare 45
DC598

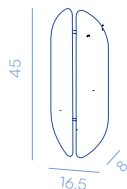

Aare 80
DC599

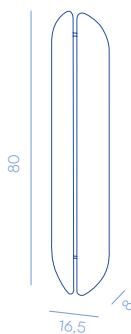

Aare 120
DC600

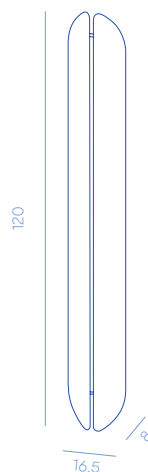

Lighting details / Dettagli illuminazione

CODE / CODICE	VOLTAGE V	FREQ. HZ	POWER W	CLASS	IP	TEMP K°	DIMMABLE
DC598	220-240V	50/60 HZ	5,5 W	I	20	3000°	YES - DALI
DC599	220-240V	50/60 HZ	14,2 W	I	20	3000°	YES - DALI
DC600	220-240V	50/60 HZ	21 W	I	20	3000°	YES - DALI

METAL FINISHES

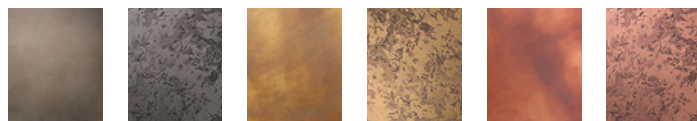

E5

H8

F2

H8

G5

H8

PRODUCT SPECIFICATION

Assembly	Shipped disassembled
Packaging	Carton box TYPE E
Details	<ul style="list-style-type: none"> Sconce characterized by two frontal metal elements Wall fixing system included, fixing screws excluded

SPECIFICHE PRODOTTO

Assemblaggio	Spedito smontato
Imballo	Scatola in cartone TIPO E
Dettagli	<ul style="list-style-type: none"> Applique caratterizzata da due elementi frontali in metallo Sistema di fissaggio a parete incluso, viti di fissaggio escluse

ON REQUEST

Finishes	<ul style="list-style-type: none"> The product can also be made upon request, subject to confirmation of feasibility by De Castelli Price on request
Dimensions	The product is available only in the dimensions listed

SU RICHIESTA

Finiture	<ul style="list-style-type: none"> Il prodotto può essere realizzato anche in finiture su richiesta, previa conferma fattibilità da parte di De Castelli Prezzo su richiesta
Dimensioni	Il prodotto è disponibile solo nelle dimensioni previste

AARE WALL 45

W. 16,5 D. 8 H. 45 cm

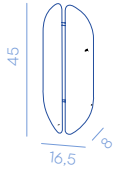

CODE / CODICE	IN	OUT	METAL FINISHES			EURO
DC598-E5	•		Stainless steel Acciaio inox	DeLabré B DeLabré B	E5	890,00
DC598-IX-H8	•		Stainless steel Acciaio inox	DeErosion DeErosion	H8	940,00
DC598-F2	•		Brass Ottone	DeLabré DeLabré	F2	1.050,00
DC598-OT-H8	•		Brass Ottone	DeErosion DeErosion	H8	1.110,00
DC598-L3	•		Brass Ottone	DeGlyphé gamma DeGlyphé gamma	L3	1.180,00
DC598-L5	•		Brass Ottone	DeGlyphé epsilon DeGlyphé epsilon	L5	1.180,00
DC598-G5	•		Copper Rame	DeLabré DeLabré	G5	1.110,00
DC598-RA-H8	•		Copper Rame	DeErosion DeErosion	H8	1.200,00

kg 2,5 kg

kg 3,5 kg

cm W. 60 D. 80 H. 70 cm

m³ 0,34 m³

N° 1

Excluding VAT
IVA esclusa

AARE WALL 80

W. 16,5 D. 8 H. 80 cm

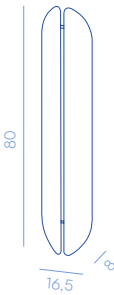

CODE / CODICE	IN	OUT	METAL FINISHES			EURO
DC599-E5	•		Stainless steel Acciaio inox	DeLabré B DeLabré B	E5	1.250,00
DC599-IX-H8	•		Stainless steel Acciaio inox	DeErosion DeErosion	H8	1.310,00
DC599-F2	•		Brass Ottone	DeLabré DeLabré	F2	1.370,00
DC599-OT-H8	•		Brass Ottone	DeErosion DeErosion	H8	1.430,00
DC599-L3	•		Brass Ottone	DeGlyphé gamma DeGlyphé gamma	L3	1.500,00
DC599-L5	•		Brass Ottone	DeGlyphé epsilon DeGlyphé epsilon	L5	1.500,00
DC599-G5	•		Copper Rame	DeLabré DeLabré	G5	1.430,00
DC599-RA-H8	•		Copper Rame	DeErosion DeErosion	H8	1.550,00

kg 4,5 kg

kg 5,5 kg

cm W. 60 D. 80 H. 105 cm

m³ 0,5 m³

N° 1

Excluding VAT
IVA esclusa

AARE WALL 120

W. 16,5 D. 8 H. 120 cm

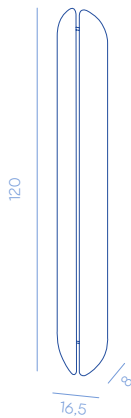

CODE / CODICE	IN	OUT	METAL FINISHES			EURO
DC600-E5	•		Stainless steel Acciaio inox	DeLabré B DeLabré B	E5	1.350,00
DC600-IX-H8	•		Stainless steel Acciaio inox	DeErosion DeErosion	H8	1.500,00
DC600-F2	•		Brass Ottone	DeLabré DeLabré	F2	1.550,00
DC600-OT-H8	•		Brass Ottone	DeErosion DeErosion	H8	1.650,00
DC600-L3	•		Brass Ottone	DeGlyphé gamma DeGlyphé gamma	L3	1.690,00
DC600-L5	•		Brass Ottone	DeGlyphé epsilon DeGlyphé epsilon	L5	1.690,00
DC600-G5	•		Copper Rame	DeLabré DeLabré	G5	1.650,00
DC600-RA-H8	•		Copper Rame	DeErosion DeErosion	H8	1.750,00

kg 6,5 kg

kg 7,5 kg

cm W. 60 D. 80 H. 145 cm

m³ 0,70 m³

N° 1

Excluding VAT
IVA esclusa

Foliage

DESIGN BY ADELE MARTELLI

Lampada decorativa a sospensione caratterizzata da due lastre in metallo e luce bidirezionale. I modelli possono essere combinati fra loro a creare composizioni.

Lampada decorativa a sospensione caratterizzata da due lastre in metallo e luce bidirezionale. I modelli possono essere combinati fra loro a creare composizioni.

Foliage 67 down
DC710

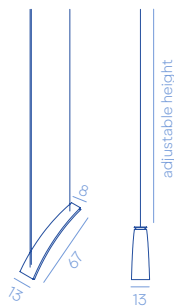

Foliage 67 up
DC711

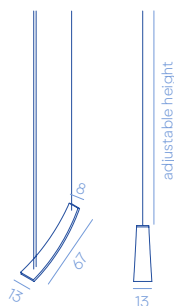

Foliage 104 up
DC712

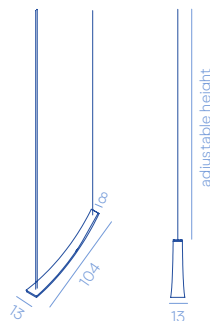

Compositions / Composizioni

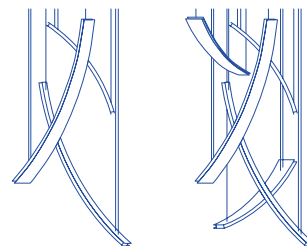

Lighting details / Dettagli illuminazione

CODE / CODICE	VOLTAGE V	FREQ. HZ	POWER W	CLASS	IP	TEMP K°	DIMMABLE
DC710	120-240V	50/60 HZ	16 W	I	44	3000°	YES - DALI
DC711	120-240V	50/60 HZ	16 W	I	44	3000°	YES - DALI
DC712	120-240V	50/60 HZ	26 W	I	44	3000°	YES - DALI

METAL FINISHES

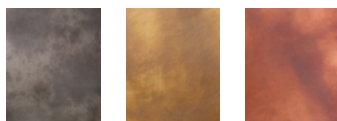

E11

F2

G5

PRODUCT SPECIFICATION

Assembly	Shipped disassembled
Packaging	To be defined at order confirmation
Details	<ul style="list-style-type: none"> - 3 independent pendant modules with incorporated transformer each in the ceiling rosette - Adjustable suspension ropes - Standard overall height 180 cm

SPECIFICHE PRODOTTO

Assemblaggio	Spedito smontato
Imballo	Da definire al momento della conferma d'ordine
Dettagli	<ul style="list-style-type: none"> - 3 moduli sospensione indipendenti con incorporato trasformatore ciascuno nel rosone del soffitto - Cavi di fissaggio regolabili - Altezza totale standard 180 cm

ON REQUEST

Finishes	<ul style="list-style-type: none"> - The product can also be made upon request, subject to confirmation of feasibility by De Castelli - Price on request
Dimensions	The product is available only in the dimensions listed

SU RICHIESTA

Finiture	<ul style="list-style-type: none"> - Il prodotto può essere realizzato anche in finiture su richiesta, previa conferma fattibilità da parte di De Castelli - Prezzo su richiesta
Dimensioni	Il prodotto è disponibile solo nelle dimensioni previste

FOLIAGE 67 DOWN

W. 68 D. 13 H. 13 cm

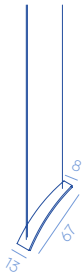

CODE / CODICE	IN	OUT	METAL FINISHES			EURO
DC710-E11	•		Stainless steel Acciaio inox	DeLabré DeLabré	E11	2.000,00
DC710-F2	•		Brass Ottone	DeLabré DeLabré	F2	2.150,00
DC710-G5	•		Copper Rame	DeLabré DeLabré	G5	2.250,00

kg 4,5 kg



Excluding VAT
IVA esclusa

FOLIAGE 67 UP

W. 68 D. 13 H. 13 cm

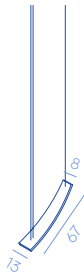

CODE / CODICE	IN	OUT	METAL FINISHES			EURO
DC711-E11	•		Stainless steel Acciaio inox	DeLabré DeLabré	E11	2.000,00
DC711-F2	•		Brass Ottone	DeLabré DeLabré	F2	2.150,00
DC711-G5	•		Copper Rame	DeLabré DeLabré	G5	2.250,00

kg 4,5 kg



Excluding VAT
IVA esclusa

FOLIAGE 104 UP

W. 106,5 D. 13 H. 13 cm

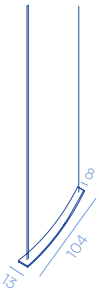

CODE / CODICE	IN	OUT	METAL FINISHES			EURO
DC712-E11	•		Stainless steel Acciaio inox	DeLabré DeLabré	E11	2.450,00
DC712-F2	•		Brass Ottone	DeLabré DeLabré	F2	2.600,00
DC712-G5	•		Copper Rame	DeLabré DeLabré	G5	2.680,00

kg 5,5 kg



Excluding VAT
IVA esclusa

Light&Shade

DESIGN BY ADELE MARTELLI

Decorative applique characterized by two overlapping metal sheets. Light sources distributed on the perimeter and between the two sheets. Possibility to direct the lamp in 3 different positions.

Applique decorativa caratterizzata da due lastre in metallo sovrapposte. Fonti luminose distribuita sul perimetro e fra le due lastre. Possibilità di orientare la lampada in 3 diverse posizioni.

Light&Shade
DC713

Compositions / Composizioni

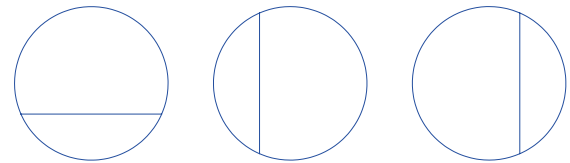
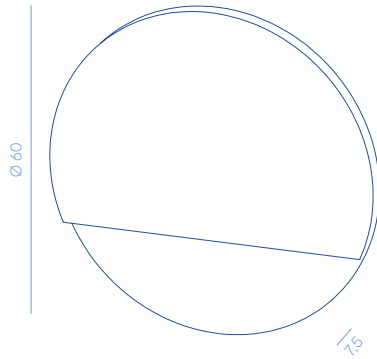

Lighting details / Dettagli illuminazione

VOLTAGE V	FREQ. HZ	POWER W	CLASS	IP	TEMP K°	DIMMABLE
120-240V	50/60 HZ	28,8 W	I	44	3000°	YES - DALI

METAL FINISHES

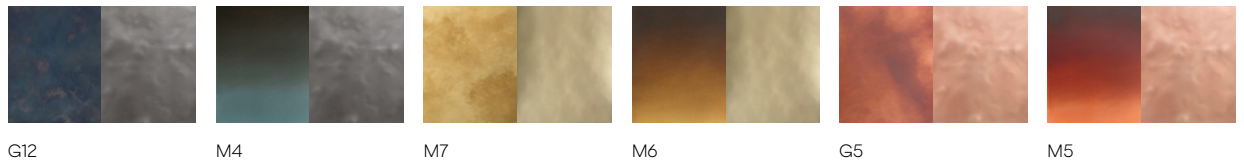

PRODUCT SPECIFICATION

Assembly	Shipped disassembled
Packaging	To be defined at order confirmation
Details	<ul style="list-style-type: none"> - Applique lighting with incorporated transformer - Integrated fixing system - Three different fixing positions

SPECIFICHE PRODOTTO

Assemblaggio	Spedito smontato
Imballo	Da definire al momento della conferma d'ordine
Dettagli	<ul style="list-style-type: none"> - Illuminazione applique con trasformatore incorporato - Sistema di fissaggio integrato - Tre diverse posizioni di fissaggio

ON REQUEST

Finishes	<ul style="list-style-type: none"> - The product can also be made upon request, subject to confirmation of feasibility by De Castelli - Price on request
Dimensions	The product is available only in the dimensions listed

SU RICHIESTA

Finiture	<ul style="list-style-type: none"> - Il prodotto può essere realizzato anche in finiture su richiesta, previa conferma fattibilità da parte di De Castelli - Prezzo su richiesta
Dimensioni	Il prodotto è disponibile solo nelle dimensioni previste



In the case of the DeMarea finishing, the shade lightens following the direction from the outside towards the inside

Nel caso della finitura DeMarea, la sfumatura schiarisce seguendo la direzione dall'esterno verso l'interno

LIGHT&SHADE

Ø 60 D. 7,5 cm



CODE / CODICE	IN	OUT	METAL FINISHES		EURO
DC713-G12	•		Stainless steel Acciaio inox	DeDeep DeDeep	G12 2.300,00
DC713-M4	•		Stainless steel Acciaio inox	DeMarea DeMarea	M4 2.350,00
DC713-M7	•		Brass Ottone	DeSalt DeSalt	M7 2.500,00
DC713-M6	•		Brass Ottone	DeMarea DeMarea	M6 2.550,00
DC713-G5	•		Copper Rame	DeLabré DeLabré	G5 2.740,00
DC713-M5	•		Copper Rame	DeLabré DeLabré	M4 2.800,00

15 kg

1

Excluding VAT
IVA esclusa

Luce Solida

DESIGN BY GUMDESIGN

Pendant decorative lamps with a diffuser made of thin metal rods.

Lampada a sospensione con diffusore costruito in sottili tondini di metallo.

Luce Solida 30
DC469

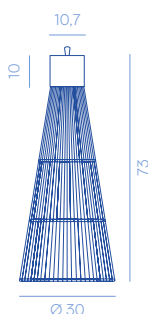

Luce Solida 42
DC470

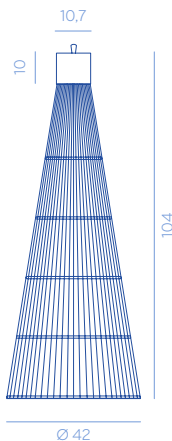

Luce Solida 88
DC471

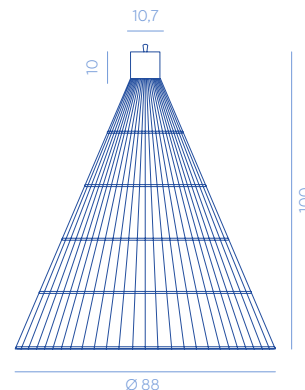

Lighting details / Dettagli illuminazione

CODE / CODICE	VOLTAGE V	FREQ. HZ	POWER W	CLASS	IP	TEMP K°	DIMMABLE
DC469	230 V	50/60 HZ	MAX 6 W	I	20	2700°	NO
DC470	230 V	50/60 HZ	MAX 6 W	I	20	2700°	NO
DC471	230 V	50/60 HZ	MAX 6 W	I	20	2700°	NO

METAL FINISHES

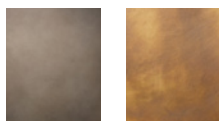

E5

F2

PRODUCT SPECIFICATION

Assembly	Shipped disassembled
Packaging	Carton box TYPE E
Details	<ul style="list-style-type: none"> - Hanging lamp with a diffuser made of thin metal rods - Supplied with a 3 m power cable and a 3 m steel fixing rope - Bracket and cable cap included, screws excluded

SPECIFICHE PRODOTTO

Assemblaggio	Spedito smontato
Imballo	Scatola in cartone TIPO E
Dettagli	<ul style="list-style-type: none"> - Lampada a sospensione con diffusore realizzato con sottili tondini di metallo - Fornito con cavo di alimentazione da 3 m e cavo di fissaggio in acciaio da 3 m - Staffa e copricavo inclusi, viti escluse

ON REQUEST

Finishes	The product is available only in the finishes listed
Dimensions	The product is available only in the dimensions listed

SU RICHIESTA

Finiture	Il prodotto è disponibile solo nelle finiture previste
Dimensioni	Il prodotto è disponibile solo nelle dimensioni previste

LUCE SOLIDA 30

Ø 30 H. 73 cm

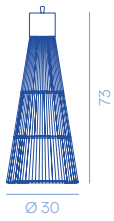

CODE / CODICE	IN	OUT	METAL FINISHES	EURO
DC469-E5	•		Stainless steel Acciaio inox	E5 1.300,00
DC469-F2	•		Brass Ottone	F2 1.400,00

kg 5 kg
 kg 6 kg
 cm W. 60 D. 80 H. 94 cm
 m³ 0,45 m³
 Nº 2
 Excluding VAT IVA esclusa

LUCE SOLIDA 42

Ø 42 H. 104 cm

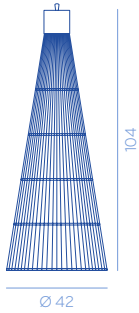

CODE / CODICE	IN	OUT	METAL FINISHES	EURO
DC470-E5	•		Stainless steel Acciaio inox	E5 1.5500,00
DC470-F2	•		Brass Ottone	F2 1.650,00

kg 6,5 kg
 kg 7,5 kg
 cm W. 47 D. 47 H. 110 cm
 m³ 0,6 m³
 Nº 1
 Excluding VAT IVA esclusa

LUCE SOLIDA 88

Ø 88 H. 100 cm

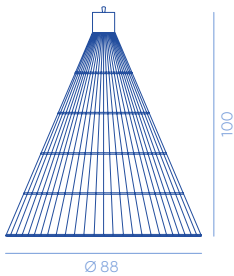

CODE / CODICE	IN	OUT	METAL FINISHES	EURO
DC471-E5	•		Stainless steel Acciaio inox	E5 1.900,00
DC471-F2	•		Brass Ottone	F2 2.000,00

kg 8 kg
 kg 11 kg
 cm W. 95 D. 95 H. 105 cm
 m³ 1,26 m³
 Nº 2
 Excluding VAT IVA esclusa

Ribot

DESIGN BY ALESSANDRO MASON

Sculptural floor lamp with hammered polished brass light diffuser.

Lampada scultorea da terra con paralume in ottone lucido martellato.

Ribot
DC502

Detailed measurements / Misure di dettaglio

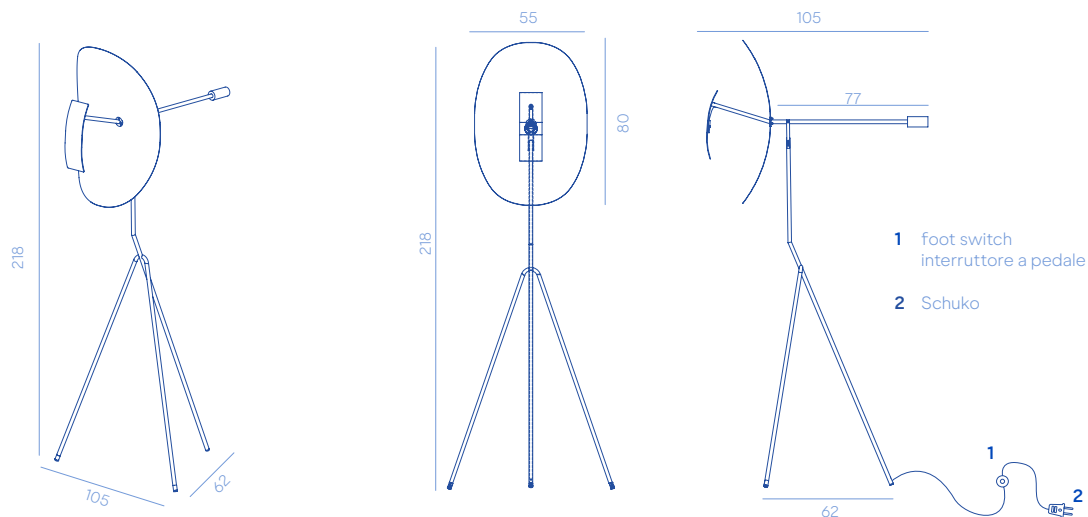

Lighting details / Dettagli illuminazione

VOLTAGE V	FREQ. HZ	POWER W	CLASS	IP	TEMP K°	DIMMABLE
230 V	50/60 HZ	11 W	II	20	3000°	NO

METAL FINISHES



G8

PRODUCT SPECIFICATION

Assembly	Shipped assembled
Packaging	Wooden cage included TYPE C
Details	Floor lamp with foot switch and European socket

ON REQUEST

Finishes	The product is available only in the finishes listed
Dimensions	The product is available only in the dimensions listed

SPECIFICHE PRODOTTO

Assemblaggio	Spedito montato
Imballo	Imballo in gabbia di legno TIPO C
Dettagli	Lampada da terra con interruttore a pedale e presa europea

SU RICHIESTA

Finiture	Il prodotto è disponibile solo nelle finiture previste
Dimensioni	Il prodotto è disponibile solo nelle dimensioni previste

RIBOT

W. 105 D. 62 H. 218 cm

CODE / CODICE	IN	OUT	METAL FINISHES	EURO
DC502-G8	•		Brass Ottone	G8 6.100,00

 13,3 kg

 35 kg

 W. 115 D. 115 H. 246 cm

 3,25 m³

 1

Excluding VAT
IVA esclusa

Twist Ceiling

DESIGN BY ZANELLATO/BORTOTTO

Sculptural pendant lamp entirely made of metal characterized by an organic volume obtained through highly artisan made hammering technique.

Lampada scultorea a sospensione interamente realizzata in metallo caratterizzata da un volume organico ottenuto attraverso una tecnica di martellatura altamente artigianale.

Twist ceiling
DC687

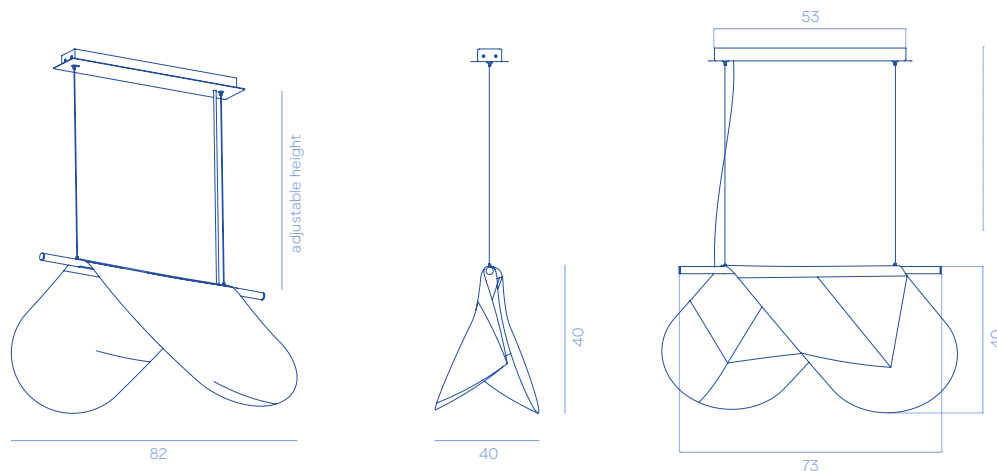

Lighting details / Dettagli illuminazione

VOLTAGE V	FREQ. HZ	POWER W	CLASS	IP	TEMP K°	DIMMABLE
220-240 V	50/60 HZ	15 W	I	20	2700°	YES - DALI

METAL FINISHES

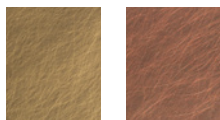

G3

G4

PRODUCT SPECIFICATION

Assembly	Shipped disassembled
Packaging	Carton box TYPE E
Details	<ul style="list-style-type: none"> - Pendant lamp with transformer incorporated in the ceiling rosette - Ceiling fixing system included, fixing screws excluded - Adjustable fixing ropes

SPECIFICHE PRODOTTO

Assemblaggio	Spedito smontato
Imballo	Scatola in cartone TIPO E
Dettagli	<ul style="list-style-type: none"> - Lampada a sospensione con trasformatore incorporato nel rosone a soffitto - Sistema di fissaggio a soffitto incluso, viti di fissaggio escluse - Cavi di fissaggio regolabili

ON REQUEST

Finishes	The product is available only in the finishes listed
Dimensions	The product is available only in the dimensions listed

SU RICHIESTA

Finiture	Il prodotto è disponibile solo nelle finiture previste
Dimensioni	Il prodotto è disponibile solo nelle dimensioni previste



Highly artisan made product, dimensional differences could occur.

Prodotto di alta fattura artigianale, potrebbero verificarsi differenze dimensionali.

TWIST CEILING

W. 82 D. 40 H. 40 cm

CODE / CODICE	IN	OUT	METAL FINISHES			EURO
DC687-G3	•		Brass Ottone	Orbitale DeLabré DeLabré orbitale	G3	3.450,00
DC687-G4	•		Copper Rame	Orbitale DeLabré DeLabré orbitale	G4	3.550,00

 8 kg

 8,5 kg

 W. 60 D. 80 H. 50 cm

 0,24 m²

 1

Excluding VAT
IVA esclusa

Twist Table

DESIGN BY ZANELLATO/BORTOTTO

Sculptural table lamp entirely made of metal characterized by an organic volume obtained through highly artisan made hammering technique.

Lampada da tavolo scultorea interamente realizzata in metallo caratterizzata da un volume organico ottenuto attraverso una tecnica di martellatura altamente artigianale.

Twist Table
DC686

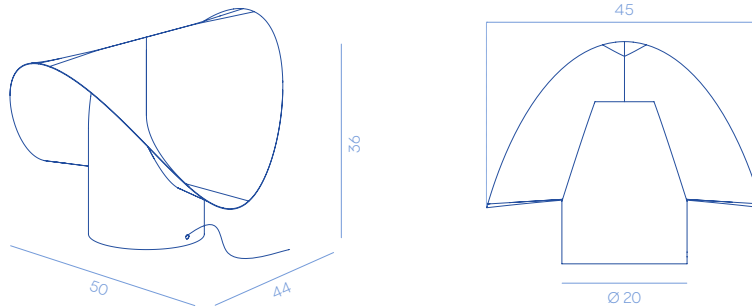

Lighting details / Dettagli illuminazione

VOLTAGE V	FREQ. HZ	POWER W	CLASS	IP	TEMP K°	DIMMABLE
220-240 V	50/60 HZ	24 W	I	20	3000°	YES - DALI

METAL FINISHES

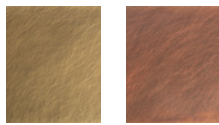

G3

G4

PRODUCT SPECIFICATION

Assembly	Shipped assembled
Packaging	Carton box TYPE E
Details	- Table lamp entirely made of metal - Cable with dimmer

SPECIFICHE PRODOTTO

Assemblaggio	Spedito montato
Imballo	Scatola in cartone TIPO E
Dettagli	- Lampada da tavolo interamente realizzata in metallo - Cavo con dimmer

ON REQUEST

Finishes	The product is available only in the finishes listed
Dimensions	The product is available only in the dimensions listed

SU RICHIESTA

Finiture	Il prodotto è disponibile solo nelle finiture previste
Dimensioni	Il prodotto è disponibile solo nelle dimensioni previste



Highly artisan made product, dimensional differences could occur.

Prodotto di alta fattura artigianale, potrebbero verificarsi differenze dimensionali.

TWISTE TABLE

W. 50 D. 44 H. 36 cm

CODE / CODICE	IN	OUT	METAL FINISHES			EURO
DC686-G3	•		Brass Ottone	Orbitale DeLabré DeLabré orbitale	G3	3.200,00
DC686-G4	•		Copper Rame	Orbitale DeLabré DeLabré orbitale	G4	3.300,00

 6 kg

 7 kg

 W. 60 D. 80 H. 50 cm

 0,24 m³

 1

Excluding VAT
IVA esclusa

Mirrors
Specchi

Brame

DESIGN BY R&D DE CASTELLI

Wall mirror with a huge concave frame entirely made of metal. LED backlit mirror option available.

Specchio da parete caratterizzato dall'importante cornice concava in metallo. Disponibile con specchio retroilluminato a LED.

Brame
DC671

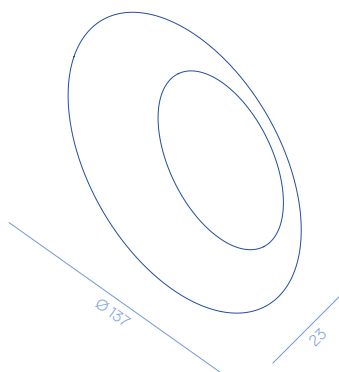

Lighting details / Dettagli illuminazione

VOLTAGE V	FREQ. HZ	POWER W	CLASS	IP	TEMP K°	DIMMABLE
230 V	50/60 HZ	37 W	I	20	2700°	NO

METAL FINISHES

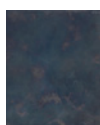

G12



G3

PRODUCT SPECIFICATION

Assembly	Shipped assembled
Packaging	Wooden crate included TYPE A
Details	<ul style="list-style-type: none">- Wall mirror with a huge concave frame entirely made of metal- LED backlit mirror option available- Wall fixing system included, fixing screws excluded

ON REQUEST

Finishes	The product is available only in the finishes listed
Dimensions	The product is available only in the dimensions listed

SPECIFICHE PRODOTTO

Assemblaggio	Spedito montato
Imballo	Imballo in cassa incluso TIPO A
Dettagli	<ul style="list-style-type: none">- Wall mirror with a huge concave frame entirely made of metal- LED backlit mirror option available- Wall fixing system included, fixing screws excluded

SU RICHIESTA

Finiture	Il prodotto è disponibile solo nelle finiture previste
Dimensioni	Il prodotto è disponibile solo nelle dimensioni previste

CODE / CODICE	IN	OUT	METAL FINISHES	EURO
---------------	----	-----	----------------	------

Ø 137 D. 23 cm

Without LED / Senza LED

DC671-G12	•		Stainless steel Acciaio inox	DeDeep DeDeep	G12	8.500,00
DC671-G3	•		Brass Ottone	Orbitale DeLabré DeLabré orbitale	G3	9.500,00

With LED / Con LED

DC671-L-G12	•		Stainless steel Acciaio inox	DeDeep DeDeep	G12	10.000,00
DC671-L-G3	•		Brass Ottone	Orbitale DeLabré DeLabré orbitale	G3	11.000,00

 50 kg

 70 kg

 W. 154 D. 154 H. 52 cm

 1,23 m³

 1

Frame

DESIGN BY ANTONELLA TESEI

Mirror characterized by a boxed metal frame to be leaned against the wall.

Specchio caratterizzato da una cornice in metallo scatolato da appoggiare a parete.

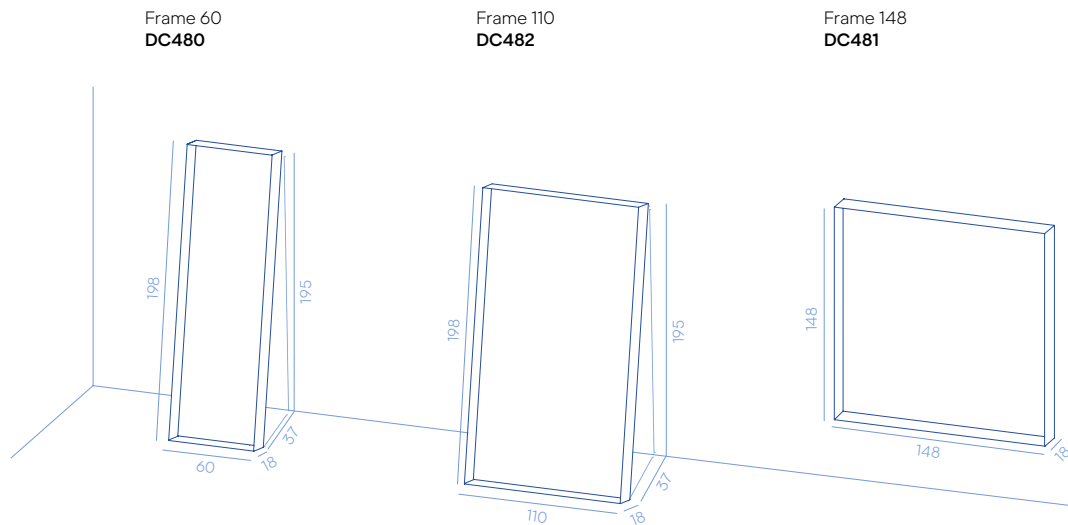

METAL FINISHES



G2

G3

G4

PRODUCT SPECIFICATION

Assembly	Shipped assembled
Packaging	Wooden crate included TYPE D
Details DC480/DC482 DC481	<ul style="list-style-type: none"> - Wall fixing system included, fixing screws excluded - Parallel and inclined wall fixing system - Parallel wall fixing system only

SPECIFICHE PRODOTTO

Assemblaggio	Spedito montato
Imballo	Imballo in cassa incluso TIPO D
Details DC480/DC482 DC481	<ul style="list-style-type: none"> - Sistema di fissaggio a parete incluso, viti di fissaggio escluse - Sistema di fissaggio a parete parallelo e inclinato - Solo sistema di fissaggio a parete parallelo

ON REQUEST

Finishes	<ul style="list-style-type: none"> - The product can also be made upon request, subject to confirmation of feasibility by De Castelli - Price on request
Dimensions	<ul style="list-style-type: none"> - The product can also be made in dimensions on request, subject to confirmation of feasibility by De Castelli - For custom made products please specify the dimensions, material and finishing - Price on request

SU RICHIESTA

Finiture	<ul style="list-style-type: none"> - Il prodotto può essere realizzato anche in finiture su richiesta, previa conferma fattibilità da parte di De Castelli - Prezzo su richiesta
Dimensioni	<ul style="list-style-type: none"> - Il prodotto può essere realizzato anche in dimensioni su richiesta, previa conferma fattibilità da parte di De Castelli - In fase di richiesta specificare le dimensioni, il materiale e la finitura - Prezzo su richiesta

FRAME 60

W. 60 D. 18 H. 198 cm

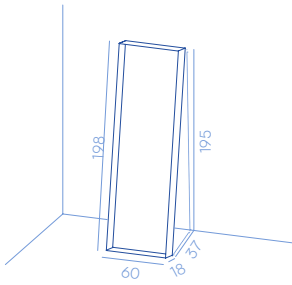

CODE / CODICE	IN	OUT	METAL FINISHES			EURO
DC480-G2	•		Stainless steel Acciaio inox	Orbitale DeLabré DeLabré Orbitale	G2	3.150,00
DC480-G3	•		Brass Ottone	Orbitale DeLabré DeLabré Orbitale	G3	4.230,00
DC480-G4	•		Copper Rame	Orbitale DeLabré DeLabré Orbitale	G4	4.930,00

kg 52 kg
 kg 55 kg
 cm W. 109 D. 109 H. 202 cm
 m² 2,40 m²
 N° 1
 Excluding VAT
IVA esclusa

FRAME 110

W. 110 D. 18 H. 198 cm

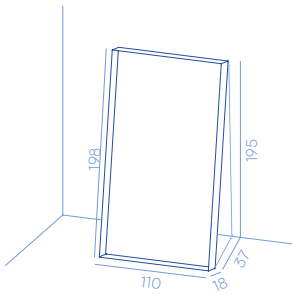

CODE / CODICE	IN	OUT	METAL FINISHES			EURO
DC482-G2	•		Stainless steel Acciaio inox	Orbitale DeLabré DeLabré Orbitale	G2	5.600,00
DC482-G3	•		Brass Ottone	Orbitale DeLabré DeLabré Orbitale	G3	6.800,00
DC482-G4	•		Copper Rame	Orbitale DeLabré DeLabré Orbitale	G4	7.400,00

kg 92 kg
 kg 110 kg
 cm W. 129 D. 109 H. 222 cm
 m² 3,70 m²
 N° 1
 Excluding VAT
IVA esclusa

FRAME 148

W. 148 D. 18 H. 148 cm

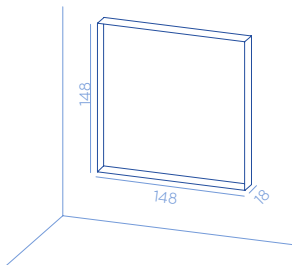

CODE / CODICE	IN	OUT	METAL FINISHES			EURO
DC481-G2	•		Stainless steel Acciaio inox	Orbitale DeLabré DeLabré Orbitale	G2	6.000,00
DC481-G3	•		Brass Ottone	Orbitale DeLabré DeLabré Orbitale	G3	7.100,00
DC481-G4	•		Copper Rame	Orbitale DeLabré DeLabré Orbitale	G4	7.800,00

kg 100 kg
 kg 130 kg
 cm W. 179 D. 109 H. 202 cm
 m² 3,94 m²
 N° 1
 Excluding VAT
IVA esclusa

Riflesso

DESIGN BY R&D DE CASTELLI

Round wall mirror characterized by a thick metal frame.

Specchio da parete rotondo caratterizzato da una spessa cornice in metallo.

Riflesso 45
DC608-450

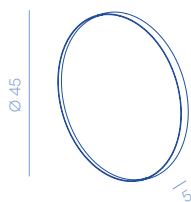

Riflesso 70
DC608-700

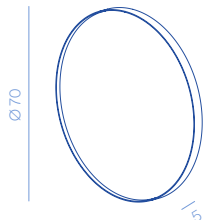

Riflesso 90
DC608-900

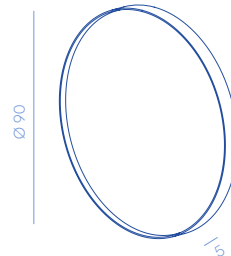

Riflesso 120
DC608-1200

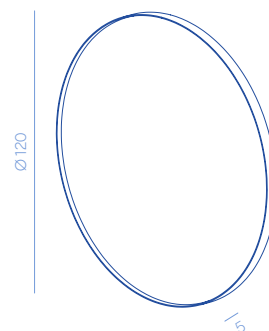

METAL FINISHES

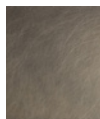

G2



G3

PRODUCT SPECIFICATION

Assembly	Shipped assembled
Packaging	Carton box TYPE E
Details	- Wall fixing system included, fixing screws excluded

SPECIFICHE PRODOTTO

Assemblaggio	Spedito montato
Imballo	Scatola in cartone TIPO E
Dettagli	- Sistema di fissaggio a parete incluso, viti di fissaggio escluse

ON REQUEST

Finishes	The product is available only in the finishes listed
Dimensions	- The product can also be made in dimensions on request, subject to confirmation of feasibility by De Castelli - For custom made products please specify the dimensions, material and finishing - Price on request

SU RICHIESTA

Finiture	Il prodotto è disponibile solo nelle finiture previste
Dimensioni	- Il prodotto può essere realizzato anche in dimensioni su richiesta, previa conferma fattibilità da parte di De Castelli - In fase di richiesta specificare le dimensioni, il materiale e la finitura - Prezzo su richiesta

RIFLESSO 45

Ø 45 D. 5 cm

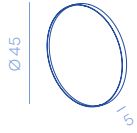

CODE / CODICE	IN	OUT	METAL FINISHES			EURO
DC608-450-G2	•		Stainless steel Acciaio inox	Orbitale DeLabré DeLabré Orbitale	G2	1.300,00
DC608-450-G3	•		Brass Ottone	Orbitale DeLabré DeLabré Orbitale	G3	1.500,00

kg 6,6 kg

kg 8 kg

cm W. 60 D. 80 H. 30 cm

m³ 0,15 m³

Nº 1

Excluding VAT
IVA esclusa

RIFLESSO 70

Ø 70 D. 5 cm

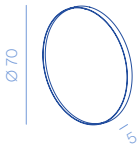

CODE / CODICE	IN	OUT	METAL FINISHES			EURO
DC608-700-G2	•		Stainless steel Acciaio inox	Orbitale DeLabré DeLabré Orbitale	G2	1.750,00
DC608-700-G3	•		Brass Ottone	Orbitale DeLabré DeLabré Orbitale	G3	2.000,00

kg 13,5 kg

kg 15 kg

cm W. 100 D. 100 H. 30 cm

m³ 0,3 m³

Nº 1

Excluding VAT
IVA esclusa

RIFLESSO 90

Ø 90 D. 5 cm

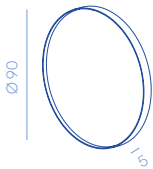

CODE / CODICE	IN	OUT	METAL FINISHES			EURO
DC608-900-G2	•		Stainless steel Acciaio inox	Orbitale DeLabré DeLabré Orbitale	G2	2.000,00
DC608-900-G3	•		Brass Ottone	Orbitale DeLabré DeLabré Orbitale	G3	2.250,00

kg 20 kg

kg 21 kg

cm W. 100 D. 100 H. 30 cm

m³ 0,3 m³

Nº 1

Excluding VAT
IVA esclusa

RIFLESSO 120

Ø 120 D. 5 cm

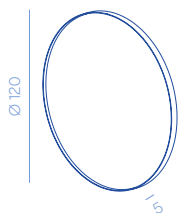

CODE / CODICE	IN	OUT	METAL FINISHES			EURO
DC608-1200-G2	•		Stainless steel Acciaio inox	Orbitale DeLabré DeLabré Orbitale	G2	3.900,00
DC608-1200-G3	•		Brass Ottone	Orbitale DeLabré DeLabré Orbitale	G3	4.600,00

kg 27 kg

kg 000 kg

cm W. 130 D. 130 H. 30 cm

m³ 0,51 m³

Nº 1

Excluding VAT
IVA esclusa

Syro Mirror

DESIGN BY EMILIO NANNI

Irregularly-shaped wall hanging mirror characterized by a thick metal frame.

Specchio da parete dalla forma irregolare caratterizzato da una spessa cornice in metallo.

Syro Mirror 56
DC620

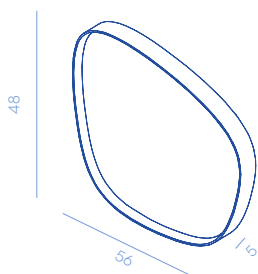

Syro Mirror 76
DC619

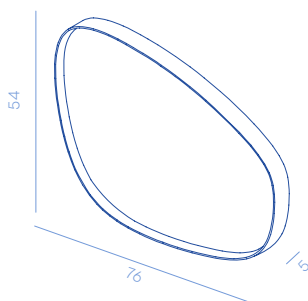

Syro Mirror 80
DC618

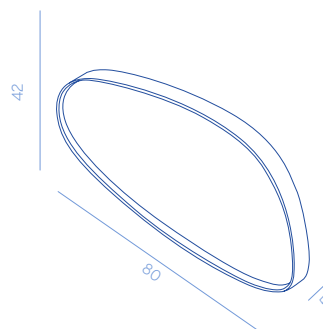

METAL FINISHES

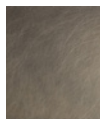

G2



G3

PRODUCT SPECIFICATION

Assembly	Shipped assembled
Packaging	Carton box TYPE E
Details	<ul style="list-style-type: none">- Wall fixing system included, fixing screws excluded- Horizontal and vertical fixing option

ON REQUEST

Finishes	The product is available only in the finishes listed
Dimensions	<ul style="list-style-type: none">- The product can also be made in dimensions on request, subject to confirmation of feasibility by De Castelli- For custom made products please specify the dimensions, material and finishing- Price on request

SPECIFICHE PRODOTTO

Assemblaggio	Spedito montato
Imballo	Scatola in cartone TIPO E
Dettagli	<ul style="list-style-type: none">- Sistema di fissaggio a parete incluso, viti di fissaggio escluse- Opzione di fissaggio in posizione sia orizzontale sia verticale

SU RICHIESTA

Finiture	Il prodotto è disponibile solo nelle finiture previste
Dimensioni	<ul style="list-style-type: none">- Il prodotto può essere realizzato anche in dimensioni su richiesta, previa conferma fattibilità da parte di De Castelli- In fase di richiesta specificare le dimensioni, il materiale e la finitura- Prezzo su richiesta

SYRO MIRROR 56

W. 56 D. 5 H. 48 cm

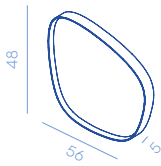

CODE / CODICE	IN	OUT	METAL FINISHES			EURO
DC620-G2	•		Stainless steel Acciaio inox	Orbitale DeLabré DeLabré Orbitale	G2	1.850,00
DC620-G3	•		Brass Ottone	Orbitale DeLabré DeLabré Orbitale	G3	2.100,00

kg 9 kg
 kg 10 kg
 cm W. 60 D. 80 H. 30 cm
 m³ 0,15 m³
 N° 1
 Excluding VAT
IVA esclusa

SYRO MIRROR 76

W. 76 D. 5 H. 54 cm

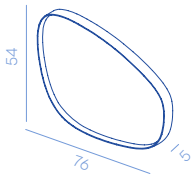

CODE / CODICE	IN	OUT	METAL FINISHES			EURO
DC619-G2	•		Stainless steel Acciaio inox	Orbitale DeLabré DeLabré Orbitale	G2	2.000,00
DC619-G3	•		Brass Ottone	Orbitale DeLabré DeLabré Orbitale	G3	2.300,00

kg 12 kg
 kg 13 kg
 cm W. 60 D. 80 H. 30 cm
 m³ 0,15 m³
 N° 1
 Excluding VAT
IVA esclusa

SYRO MIRROR 80

W. 80 D. 5 H. 42 cm

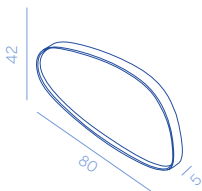

CODE / CODICE	IN	OUT	METAL FINISHES			EURO
DC618-G2	•		Stainless steel Acciaio inox	Orbitale DeLabré DeLabré Orbitale	G2	2.200,00
DC618-G3	•		Brass Ottone	Orbitale DeLabré DeLabré Orbitale	G3	2.450,00



kg 10,5 kg
 kg 11,5 kg
 cm W. 100 D. 100 H. 30 cm
 m³ 0,3 m³
 N° 1
 Excluding VAT
IVA esclusa

Frames
Quadri

Arazzi Re

DESIGN BY GUMDESIGN



	CODE / CODICE	IN	OUT	METAL FINISHES	EURO
 W. 180 D. 4,5 H. 210 cm  107 kg	DA103	•		Custom DeErosion brass and brass finish stainless steel frame Ottone DeErosion custom e cornice in acciaio inox finitura ottone	14.000,00

Fixing system included, fixing screws excluded / Incluso sistema di fissaggio a parete, viti di fissaggio escluse
Wooden crate included **TYPE B** / Imballo in cassa incluso **TIPO B**



Excluding VAT
IVA esclusa

 W. 197 D. 80 H. 236 cm  3,71 m³

Arazzi Regina

DESIGN BY GUMDESIGN



	CODE / CODICE	IN	OUT	METAL FINISHES	EURO
 W. 180 D. 4,5 H. 210 cm  107 kg	DA104	•		Custom DeErosion brass and brass finish stainless steel frame Ottone DeErosion custom e cornice in acciaio inox finitura ottone	14.000,00

Fixing system included, fixing screws excluded / Incluso sistema di fissaggio a parete, viti di fissaggio escluse
Wooden crate included **TYPE B** / Imballo in cassa incluso **TIPO B**



Excluding VAT
IVA esclusa

 W. 197 D. 80 H. 236 cm  3,71 m³

Hexagon

DESIGN BY R&D DE CASTELLI



	CODE / CODICE	IN	OUT	METAL FINISHES	EURO
 W. 190 D. 4,5 H. 210 cm  107 kg	DA108	•		DeErosion H8 copper and brushed copper and copper finish stainless steel frame Rame DeErosion H8 e rame spazzolato e cornice in acciaio inox finitura rame	12.000,00

Fixing system included, fixing screws excluded / Incluso sistema di fissaggio a parete, viti di fissaggio escluse
Wooden crate included **TYPE B** / Imbalo in cassa incluso **TIPO B**



Excluding VAT
IVA esclusa

 W. 207 D. 80 H. 236 cm  3,90 m³

Erosion



DESIGN BY R&D DE CASTELLI



	CODE / CODICE	IN	OUT	METAL FINISHES	EURO
 W. 150 D. 4,5 H. 210 cm  66 kg	DA105	•		Mixed DeErosion finishes on brass and brass finish stainless steel frame Mix finiture DeErosion su ottone e cornice in acciaio inox finitura ottone	12.000,00

Fixing system included, fixing screws excluded / Incluso sistema di fissaggio a parete, viti di fissaggio escluse
Wooden crate included **TYPE B** / Imbalo in cassa incluso **TIPO B**



Excluding VAT
IVA esclusa

 W. 167 D. 80 H. 236 cm  3,15 m³

Poyangi

DESIGN BY EMILIO NANNI



	CODE / CODICE	IN	OUT	METAL FINISHES	EURO
 W. 100 D. 4,5 H. 200 cm  60 kg	DA107	•		Finiture miste su rame e smalto a fuoco su rame e cornice in acciaio inox finitura rame Mixed copper finishes and enameled copper and copper finish stainless steel frame	20.000,00

Fixing system included, fixing screws excluded / Incluso sistema di fissaggio a parete, viti di fissaggio escluse
 Wooden crate included **TYPE B** / Imbalo in cassa incluso **TIPO B**



Excluding VAT
IVA esclusa

 W. 116 D. 80 H. 226 cm  2,10 m³

Solar

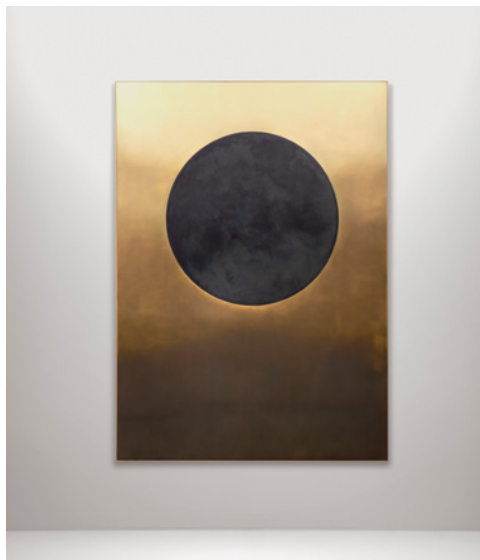
DESIGN BY ZANELLATO/BORTOTTO



	CODE / CODICE	IN	OUT	METAL FINISHES	EURO
 W. 122 D. 4,5 H. 170 cm  50 kg	DA106	•		DeMarea brass with Dedeep stainless steel insert and brass finish stainless steel frame Ottone DeMarea con inserto in acciaio inox DeDeep e cornice in acciaio inox finitura ottone	7.400,00

Fixing system included, fixing screws excluded / Incluso sistema di fissaggio a parete, viti di fissaggio escluse
 Wooden crate included **TYPE B** / Imbalo in cassa incluso **TIPO B**



Excluding VAT
IVA esclusa

 W. 139 D. 80 H. 196 cm  2,17 m³

Wild Geometries

DESIGN BY ELENA SALMISTRARO



	CODE / CODICE	IN	OUT	METAL FINISHES	EURO
 W. 180 D. 4,5 H. 210 cm  107 kg	DA102	•		Custom DeErosion brass and brass finish stainless steel frame Ottone DeErosion custom e cornice in acciaio inox finitura ottone	14.000,00

Fixing system included, fixing screws excluded / Incluso sistema di fissaggio a parete, viti di fissaggio escluse
Wooden crate included **TYPE B** / Imbalo in cassa incluso **TIPO B**



Excluding VAT
IVA esclusa

 W. 197 D. 80 H. 236 cm  3,71 m³

Yoko 01

DESIGN BY LEONARDO SONNOLI



	CODE / CODICE	IN	OUT	METAL FINISHES	EURO
 W. 150 D. 4,5 H. 210 cm  90 kg	DA100	•		DeDeep stainless steel elements with brushed brass inserts and brass finish stainless steel frame Elementi in acciaio inox DeDeep con inserti in ottone spazzolato e cornice in acciaio inox finitura ottone	8.500,00

Fixing system included, fixing screws excluded / Incluso sistema di fissaggio a parete, viti di fissaggio escluse
Wooden crate included **TYPE B** / Imbalo in cassa incluso **TIPO B**



Excluding VAT
IVA esclusa

 W. 167 D. 80 H. 236 cm  3,15 m³

Yoko 02



DESIGN BY LEONARDO SONNOLI



	CODE / CODICE	IN	OUT	METAL FINISHES	EURO
 W. 150 D. 4,5 H. 210 cm  90 kg	DA101	•		DeDeep stainless steel elements with brushed copper inserts and copper finish stainless steel frame Elementi in acciaio inox DeDeep con inserti in rame spazzolato e cornice in acciaio inox finitura rame	8.500,00

Fixing system included, fixing screws excluded / Incluso sistema di fissaggio a parete, viti di fissaggio escluse
Wooden crate included [TYPE B](#) / Imbalo in cassa incluso [TIPO B](#)

Excluding VAT
IVA esclusa

 W. 167 D. 80 H. 236 cm  3,15 m³

Your signature

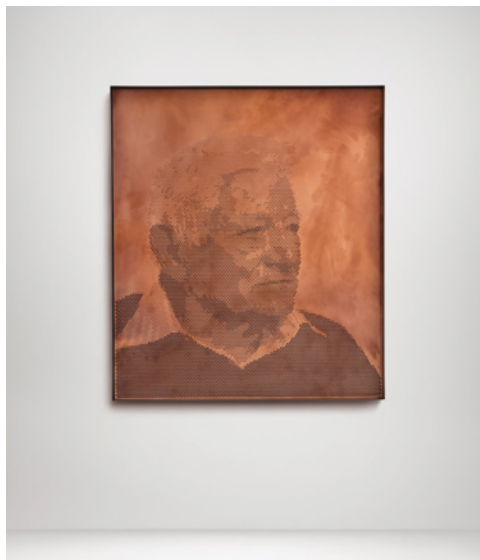

Custom piece of art available on project.
Possibilità di realizzazione di opera d'arte su progetto.

ON REQUEST / SU RICHIESTA

CODE / CODICE	METAL FINISHES	€ PER PIECE / € AL PREZZO
SOLAR-IX	DeMarea stainless steel with DeDeep stainless steel insert and stainless steel frame Acciaio inox DeMarea con inserto in acciaio inox DeDeep e cornice in acciaio inox	DA106+15%
SOLAR-RA	DeMarea copperwith DeDeep stainless steel insert and stainless steel frame Rame DeMarea con inserto in acciaio inox DeDeep e cornice in acciaio inox	DA106 +15%

Fixing system included, fixing screws excluded / Incluso sistema di fissaggio a parete, viti di fissaggio escluse
Wooden crate included [TYPE B](#) / Imballo in cassa incluso [TIPO B](#)

Excluding VAT
IVA esclusa

Pots
Vasi

A-Modulo

DESIGN BY R&D DE CASTELLI

Modular flower pot composed of different online elements, particularly suitable for use in gardens, parks and urban spaces.

Fioriera modulare composta da diversi elementi in linea, particolarmente adatta per l'utilizzo in giardini, parchi e spazi urbani.

A-Modulo 40

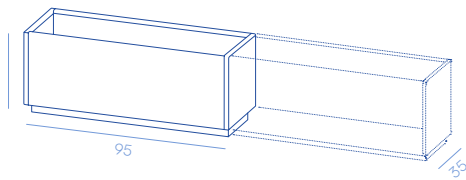

A-Modulo 60

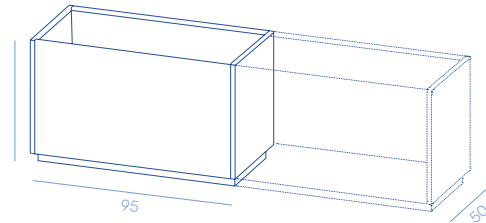

Specify in the order if for indoor or outdoor.

Specificare nell'ordine se per uso interno o esterno.

METAL FINISHES



D3

D8

D1

E8

E9

PRODUCT SPECIFICATION

Assembly	Shipped disassembled
Packaging	Carton box TYPE E
Details	<ul style="list-style-type: none"> - Modular flower pot composed by different on-line elements - Drainage composites included - Fixing cross to be added starting from two subsequent modules

SPECIFICHE PRODOTTO

Assemblaggio	Spedito smontato
Imballo	Scatola in cartone TIPO E
Dettagli	<ul style="list-style-type: none"> - Fioriera modulare composta da diversi elementi in linea - Compositi drenanti inclusi - Croce di fissaggio da aggiungere a partire da due moduli successivi

ON REQUEST

Finishes	<ul style="list-style-type: none"> - The product can also be made in finishes on request, subject to confirmation of feasibility by De Castelli - Price on request
Dimensions	<ul style="list-style-type: none"> - The product can also be made in dimensions on request, subject to confirmation of feasibility by De Castelli. - For custom made products please specify the dimensions, material and finishing - Price on request

SU RICHIESTA

Finiture	<ul style="list-style-type: none"> - Il prodotto può essere realizzato anche in finiture su richiesta, previa conferma fattibilità da parte di De Castelli - Prezzo su richiesta
Dimensioni	<ul style="list-style-type: none"> - Il prodotto può essere realizzato anche in dimensioni su richiesta, previa conferma fattibilità da parte di De Castelli - In fase di richiesta specificare le dimensioni, il materiale e la finitura - Prezzo su richiesta

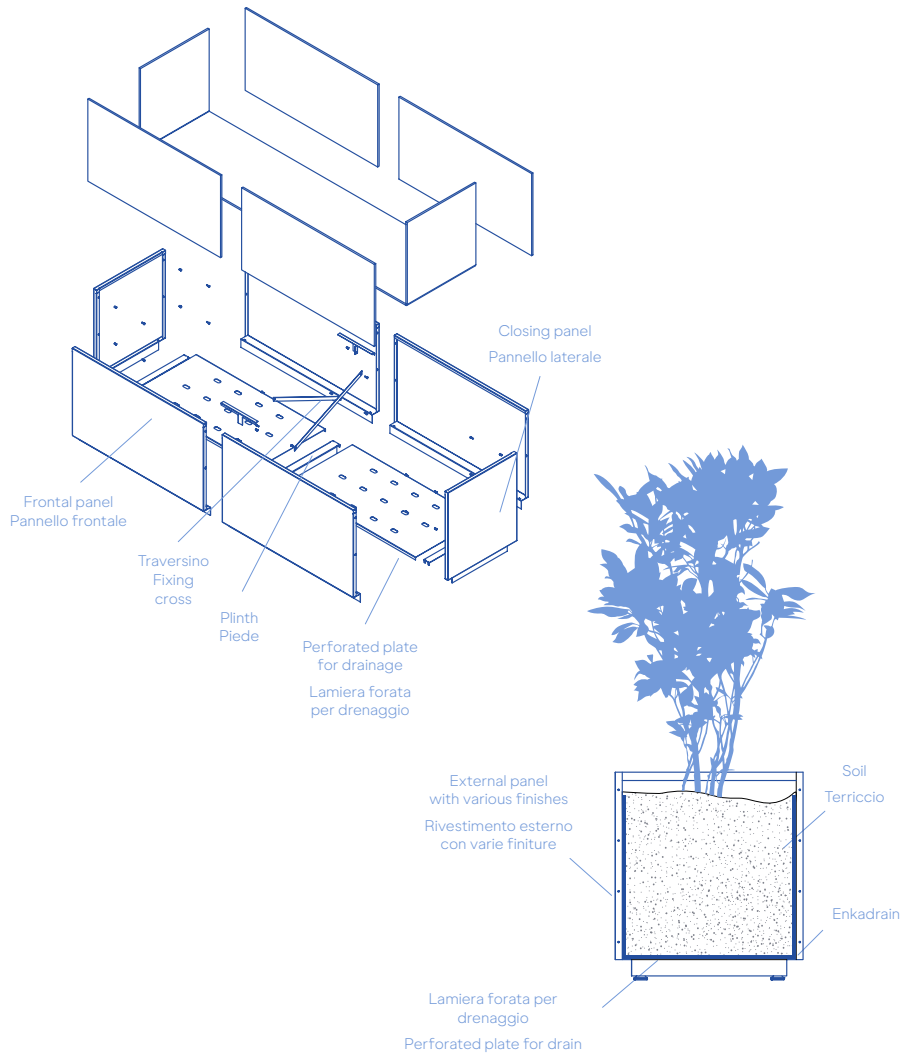

A-Modulo 40

Frontal view
Vista frontale

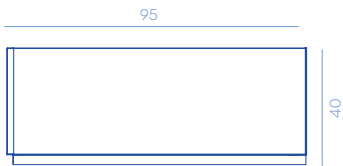

Side view
Vista laterale

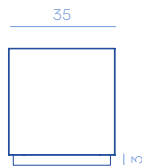

Top view
Vista superiore

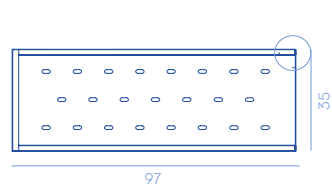

A-Modulo 60

Frontal view
Vista frontale

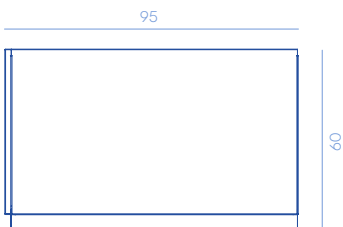

Side view
Vista laterale

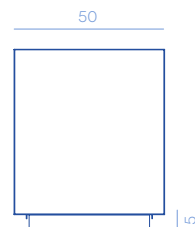

Top view
Vista superiore

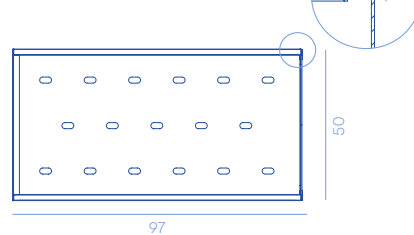

A-MODULO 40 FRONT

W. 95 D. 2 H. 40 cm

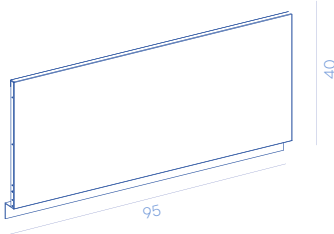

CODE / CODICE	IN	OUT	METAL FINISHES	EURO
DC354-D1		•	Stainless steel Acciaio inox Satin Satinato	D1 220,00
DC354-E8		•	Stainless steel Acciaio inox Noir Sablè Noir Sablè	E8 280,00
DC354-E9		•	Stainless steel Acciaio inox Marron Sablè Marron Sablè	E9 280,00
DC354-D8		•	Stainless steel Acciaio inox Lacquered RAL 9010 Laccato RAL 9010	D8 300,00
DC354-D3		•	Stainless steel Acciaio inox DeMaïstral Brunito DeMaïstral Brunito	D3 320,00

kg 5,5 kg
 kg 6 kg
 cm W. 100 D. 45 H. 5 cm
 m³ 0,02 m³
 Nº 1
 Excluding VAT
IVA esclusa

A-MODULO 40 SIDE

W. 35 D. 2 H. 40 cm

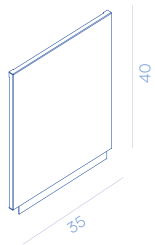

CODE / CODICE	IN	OUT	METAL FINISHES	EURO
DC355-D1		•	Stainless steel Acciaio inox Satin Satinato	D1 150,00
DC355-E8		•	Stainless steel Acciaio inox Noir Sablè Noir Sablè	E8 190,00
DC355-E9		•	Stainless steel Acciaio inox Marron Sablè Marron Sablè	E9 190,00
DC355-D8		•	Stainless steel Acciaio inox Lacquered RAL 9010 Laccato RAL 9010	D8 220,00
DC355-D3		•	Stainless steel Acciaio inox DeMaïstral Brunito DeMaïstral Brunito	D3 250,00

kg 2 kg
 kg 2,5 kg
 cm W. 40 D. 53 H. 5 cm
 m³ 0,01 m³
 Nº 1
 Excluding VAT
IVA esclusa

A-MODULO KIT

W. 00 D. 00 H. 00 cm

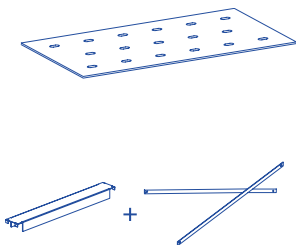

CODE / CODICE	IN	OUT	METAL FINISHES	EURO
DC356-IX		•	Stainless steel Acciaio inox	190,00
DC357-IX-304		•	Stainless steel Acciaio inox	75,00

kg 4+1 kg
 kg 5,5 kg
 cm W. 40 D. 100 H. 10 cm
 m³ 0,04 m³
 Nº 1
 Excluding VAT
IVA esclusa

A-MODULO 60 FRONT

W. 95 D. 2 H. 60 cm

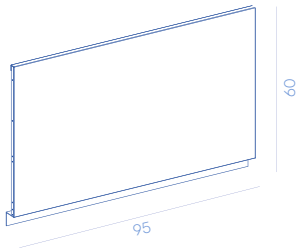

CODE / CODICE	IN	OUT	METAL FINISHES	EURO
DC350-D1		•	Stainless steel Acciaio inox Satin Satinato	D1 280,00
DC350-E8		•	Stainless steel Acciaio inox Noir Sablè Noir Sablè	E8 350,00
DC350-E9		•	Stainless steel Acciaio inox Marron Sablè Marron Sablè	E9 350,00
DC350-D8		•	Stainless steel Acciaio inox Lacquered RAL 9010 Laccato RAL 9010	D8 400,00
DC350-D3		•	Stainless steel Acciaio inox DeMastral Brunito DeMastral Brunito	D3 430,00

kg 8 kg

kg 8,5 kg

cm W. 65 D. 100 H. 5 cm

m³ 0,03 m³

N° 1

Excluding VAT
IVA esclusa

A-MODULO 60 SIDE

W. 50 D. 2 H. 60 cm

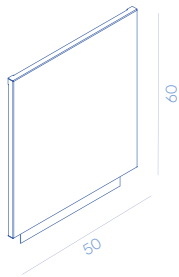

CODE / CODICE	IN	OUT	METAL FINISHES	EURO
DC351-D1		•	Stainless steel Acciaio inox Satin Satinato	D1 190,00
DC351-E8		•	Stainless steel Acciaio inox Noir Sablè Noir Sablè	E8 250,00
DC351-E9		•	Stainless steel Acciaio inox Marron Sablè Marron Sablè	E9 250,00
DC351-D8		•	Stainless steel Acciaio inox Lacquered RAL 9010 Laccato RAL 9010	D8 350,00
DC351-D3		•	Stainless steel Acciaio inox DeMastral Brunito DeMastral Brunito	D3 380,00

kg 4,5 kg

kg 5 kg

cm W. 65 D. 55 H. 5 cm

m³ 0,02 m³

N° 1

Excluding VAT
IVA esclusa

A-MODULO KIT

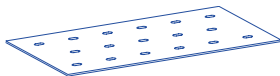

CODE / CODICE	IN	OUT	METAL FINISHES	EURO
DC356-IX		•	Stainless steel Acciaio inox	230,00
DC353-IX-304		•	Stainless steel Acciaio inox	98,00

kg 5,5+1,5 kg

kg 7 kg

cm W. 55 D. 105 H. 10 cm

m³ 0,05 m³

N° 1

Excluding VAT
IVA esclusa

Cohiba large

DESIGN BY R&D DE CASTELLI

"Large" cylindrical cachepot entirely made of metal.

Cachepot cilindrico "Large" interamente realizzato in metallo.

Cohiba large 57
DC410

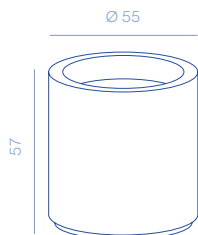

Cohiba large 82
DC411

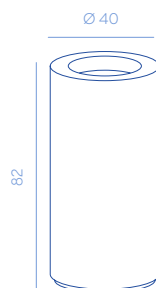

Specify in the order if for indoor or outdoor.

Specificare nell'ordine se per uso interno o esterno.

METAL FINISHES



D6

D7

G2

D3

D8

D1

PRODUCT SPECIFICATION

Assembly	Shipped assembled
Packaging	Carton box TYPE E
Details	<ul style="list-style-type: none"> - Inner plastic pot included - Equipped with closed base for an indoor use, perforated base for outdoor - The indoor or outdoor use has to be specified at order confirmation - Fixing floor plate available on request

SPECIFICHE PRODOTTO

Assemblaggio	Spedito montato
Imballo	Scatola in cartone TIPO E
Dettagli	<ul style="list-style-type: none"> - Vaso interno incluso - Caratterizzata da base chiusa per utilizzo interno e base forata per utilizzo esterno - Specificare al momento dell'ordine se per uso interno o esterno - Piastra per fissaggio a terra disponibile su richiesta

ON REQUEST

Finishes	<ul style="list-style-type: none"> - The product can also be made in finishes on request, subject to confirmation of feasibility by De Castelli - Price on request
Dimensions	<ul style="list-style-type: none"> - The product can also be custom made in dimensions on request, subject to confirmation of feasibility by De Castelli - Price on request

SU RICHIESTA

Finiture	<ul style="list-style-type: none"> - Il prodotto può essere realizzato anche in finiture su richiesta, previa conferma fattibilità da parte di De Castelli - Prezzo su richiesta
Dimensioni	<ul style="list-style-type: none"> - Il prodotto può essere realizzato anche in dimensioni su richiesta, previa conferma fattibilità da parte di De Castelli - Prezzo su richiesta

COHIBA LARGE 57

Ø. 55 H. 57 cm

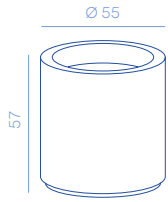

CODE / CODICE	IN	OUT	METAL FINISHES			EURO
DC410-D6		•	Corten Corten	Natural Naturale	D6	915,00
DC410-D7	•		Corten Corten	Waxed Cerato	D7	970,00
DC410-D8	•	•	Stainless steel Acciaio inox	Lacquered RAL 9010 Laccato RAL 9010	D8	1.180,00
DC410-D1	•	•	Stainless steel Acciaio inox	Satin Satinato	D1	1.160,00
DC410-G2	•	•	Stainless steel Acciaio inox	Orbitale DeLabré DeLabré Orbitale	G2	1.190,0
DC410-D3	•	•	Stainless steel Acciaio inox	DeMastral Brunito DeMastral Brunito	D3	1.250,00

kg 18 kg

kg 19 kg

cm W. 60 D. 80 H. 78 cm

m² 0,78 m²

N° 1

Excluding VAT
IVA esclusa

COHIBA LARGE 82

Ø. 40 H. 82 cm

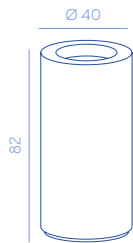

CODE / CODICE	IN	OUT	METAL FINISHES			EURO
DC411-D6		•	Corten Corten	Natural Naturale	D6	840,00
DC411-D7	•		Corten Corten	Waxed Cerato	D7	950,00
DC411-D8	•	•	Stainless steel Acciaio inox	Lacquered RAL 9010 Laccato RAL 9010	D8	1.060,00
DC411-D1	•	•	Stainless steel Acciaio inox	Satin Satinato	D1	1.080,00
DC411-G2	•	•	Stainless steel Acciaio inox	Orbitale DeLabré DeLabré Orbitale	G2	1.180,00
DC411-D3	•	•	Stainless steel Acciaio inox	DeMastral Brunito DeMastral Brunito	D3	1.180,00

kg 16 kg

kg 17 kg

cm W. 60 D. 80 H. 103 cm

m² 0,50 m²

N° 1

Excluding VAT
IVA esclusa

Cohiba slim

DESIGN BY R&D DE CASTELLI

"Slim" cylindrical cachepot entirely made of metal.

Cachepot cilindrico "Slim" interamente realizzato in metallo.

Cohiba slim 82
DC412

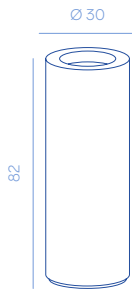

Cohiba slim 122
DC413

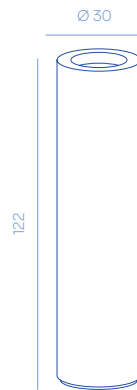

Cohiba slim 142
DC414

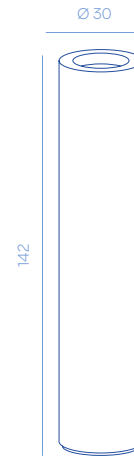

Specify in the order if for indoor or outdoor.

Specificare nell'ordine se per uso interno o esterno.

METAL FINISHES

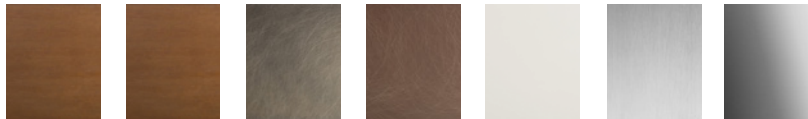

D6

D7

G2

D3

D8

D1

D2

PRODUCT SPECIFICATION

Assembly	Shipped assembled
Packaging	Carton box TYPE E
Details	<ul style="list-style-type: none"> - Inner plastic pot included - Equipped with closed base for an indoor use, perforated base for outdoor - The indoor or outdoor use has to be specified at order confirmation - Fixing floor plate available upon request

SPECIFICHE PRODOTTO

Assemblaggio	Spedito montato
Imballo	Scatola in cartone TIPO E
Dettagli	<ul style="list-style-type: none"> - Vaso interno incluso - Caratterizzata da base chiusa per utilizzo interno e base forata per utilizzo esterno - Specificare al momento dell'ordine se per uso interno o esterno - Piastra per fissaggio a terra disponibile su richiesta

ON REQUEST

Finishes	<ul style="list-style-type: none"> - The product can also be made in finishes on request, subject to confirmation of feasibility by De Castelli - Price on request
Dimensions	<ul style="list-style-type: none"> - The product can also be custom made in dimensions on request, subject to confirmation of feasibility by De Castelli - Price on request

SU RICHIESTA

Finiture	<ul style="list-style-type: none"> - Il prodotto può essere realizzato anche in finiture su richiesta, previa conferma fattibilità da parte di De Castelli - Prezzo su richiesta
Dimensioni	<ul style="list-style-type: none"> - Il prodotto può essere realizzato anche in dimensioni su richiesta, previa conferma fattibilità da parte di De Castelli - Prezzo su richiesta

COHIBA SLIM 82

Ø. 30 H. 82 cm

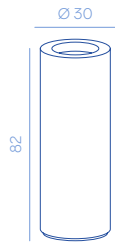

CODE / CODICE	IN	OUT	METAL FINISHES			EURO
DC412-D6		•	Corten Corten	Natural Naturale	D6	670,00
DC412-D7	•		Corten Corten	Waxed Cerato	D7	834,00
DC412-D8	•	•	Stainless steel Acciaio inox	Lacquered RAL 9010 Laccato RAL 9010	D8	773,00
DC412-D1	•	•	Stainless steel Acciaio inox	Satin Satinato	D1	920,00
DC412-D2	•	•	Stainless steel Acciaio inox	Polished Lucido	D2	980,00
DC412-D3	•	•	Stainless steel Acciaio inox	DeMaistral Brunito DeMaistral Brunito	D3	1.030,00
DC412-G2	•	•	Stainless steel Acciaio inox	Orbitale DeLabré DeLabré Orbitale	G2	1.138,00

kg 11 kg

kg 12 kg

cm W. 60 D. 80 H. 103 cm

m³ 0,50 m³

Nº 1

Excluding VAT
IVA esclusa

COHIBA SLIM 122

Ø. 30 H. 122 cm



CODE / CODICE	IN	OUT	METAL FINISHES			EURO
DC413-D6		•	Corten Corten	Natural Naturale	D6	710,00
DC413-D7	•		Corten Corten	Waxed Cerato	D7	1.000,00
DC413-D8	•	•	Stainless steel Acciaio inox	Lacquered RAL 9010 Laccato RAL 9010	D8	937,00
DC413-D1	•	•	Stainless steel Acciaio inox	Satin Satinato	D1	990,00
DC413-D2	•	•	Stainless steel Acciaio inox	Polished Lucido	D2	1.081,00
DC413-D3	•	•	Stainless steel Acciaio inox	DeMaistral Brunito DeMaistral Brunito	D3	1.120,00
DC413-G2	•	•	Stainless steel Acciaio inox	Orbitale DeLabré DeLabré Orbitale	G2	1.160,00

kg 11,5 kg

kg 12,5 kg

cm W. 60 D. 80 H. 143 cm

m³ 0,70 m³

Nº 1

Excluding VAT
IVA esclusa

COHIBA SLIM 142

Ø. 30 H. 142 cm

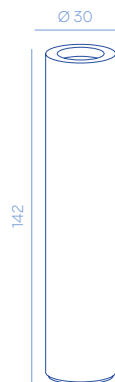

CODE / CODICE	IN	OUT	METAL FINISHES			EURO
DC414-D6		•	Corten Corten	Natural Naturale	D6	790,00
DC414-D7	•		Corten Corten	Waxed Cerato	D7	1.030,00
DC414-D8	•	•	Stainless steel Acciaio inox	Lacquered RAL 9010 Laccato RAL 9010	D8	1.080,00
DC414-D1	•	•	Stainless steel Acciaio inox	Satin Satinato	D1	1.190,00
DC414-D2	•	•	Stainless steel Acciaio inox	Polished Lucido	D2	1.240,00
DC414-D3	•	•	Stainless steel Acciaio inox	DeMaistral Brunito DeMaistral Brunito	D3	1.240,00
DC414-G2	•	•	Stainless steel Acciaio inox	Orbitale DeLabré DeLabré Orbitale	G2	1.280,00

kg 12 kg

kg 13 kg

cm W. 60 D. 80 H. 162 cm

m³ 0,80 m³

Nº 1

Excluding VAT
IVA esclusa

Conique

DESIGN BY FILIPPO PISAN

Conical cachepot entirely made of metal.

Cachepot conico interamente realizzato in metallo.

Conique 27
DC408

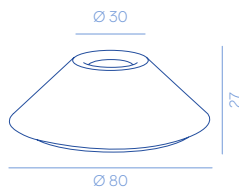

Conique 62
DC407

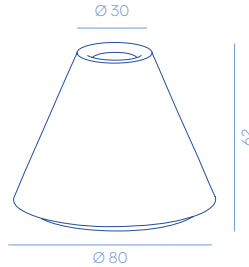

Conique 102
DC406

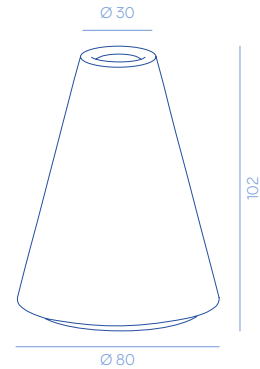

Specify in the order if for indoor or outdoor.

Specificare nell'ordine se per uso interno o esterno.

METAL FINISHES

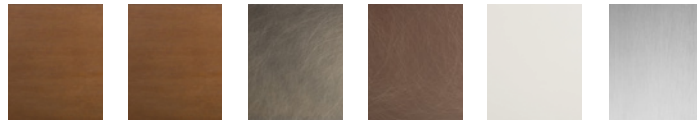

D6

D7

G2

D3

D8

D1

PRODUCT SPECIFICATION

Assembly	Shipped assembled
Packaging	Carton box TYPE E
Details	<ul style="list-style-type: none"> - Inner plastic pot included - Equipped with closed base for an indoor use, perforated base for outdoor - The indoor or outdoor use has to be specified at order confirmation - Fixing floor plate available on request

SPECIFICHE PRODOTTO

Assemblaggio	Spedito montato
Imballo	Scatola in cartone TIPO E
Dettagli	<ul style="list-style-type: none"> - Vaso interno incluso - Caratterizzata da base chiusa per utilizzo interno e base forata per utilizzo esterno - Specificare al momento dell'ordine se per uso interno o esterno - Piastra per fissaggio a terra disponibile su richiesta

ON REQUEST

Finishes	<ul style="list-style-type: none"> - The product can also be made in finishes on request, subject to confirmation of feasibility by De Castelli - Price on request
Dimensions	<ul style="list-style-type: none"> - The product can also be custom made in dimensions on request, subject to confirmation of feasibility by De Castelli - Price on request

SU RICHIESTA

Finiture	<ul style="list-style-type: none"> - Il prodotto può essere realizzato anche in finiture su richiesta, previa conferma fattibilità da parte di De Castelli - Prezzo su richiesta
Dimensioni	<ul style="list-style-type: none"> - Il prodotto può essere realizzato anche in dimensioni su richiesta, previa conferma fattibilità da parte di De Castelli - Prezzo su richiesta

CONIQUE 27

Ø. 30 Ø. 80 H. 27 cm

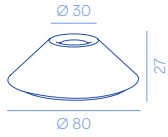

CODE / CODICE	IN	OUT	METAL FINISHES			EURO
DC408-D6		•	Corten Corten	Natural Naturale	D6	1.130,00
DC408-D7	•		Corten Corten	Waxed Cerato	D7	1.190,00
DC408-D3	•	•	Stainless steel Acciaio inox	DeMastral Brunito DeMastral Brunito	D3	1.300,00
DC408-D1	•	•	Stainless steel Acciaio inox	Satin Satinato	D1	1.360,00
DC408-D8	•	•	Stainless steel Acciaio inox	Lacquered RAL 9010 Laccato RAL 9010	D8	1.600,00

kg 15 kg

kg 16 kg

cm W. 100 D. 100 H. 48 cm

m³ 0,50 m³

N° 1

Excluding VAT
IVA esclusa

CONIQUE 62

Ø. 30 Ø. 80 H. 62 cm

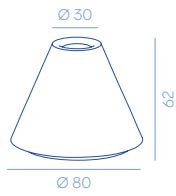

CODE / CODICE	IN	OUT	METAL FINISHES			EURO
DC407-D6		•	Corten Corten	Natural Naturale	D6	1.190,00
DC407-D7	•		Corten Corten	Waxed Cerato	D7	1.240,00
DC407-D3	•	•	Stainless steel Acciaio inox	DeMastral Brunito DeMastral Brunito	D3	1.560,00
DC407-D1	•	•	Stainless steel Acciaio inox	Satin Satinato	D1	1.530,00
DC407-D8	•	•	Stainless steel Acciaio inox	Lacquered RAL 9010 Laccato RAL 9010	D8	1.360,00

kg 18,5 kg

kg 19,5 kg

cm W. 100 D. 100 H. 83 cm

m³ 0,85 m³

N° 1

Excluding VAT
IVA esclusa

CONIQUE 102

Ø. 30 Ø. 80 H. 102 cm

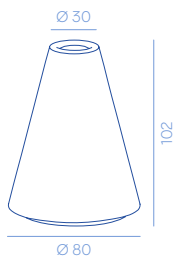

CODE / CODICE	IN	OUT	METAL FINISHES			EURO
DC406-D6		•	Corten Corten	Natural Naturale	D6	1.240,00
DC406-D7	•		Corten Corten	Waxed Cerato	D7	1.300,00
DC406-D3	•	•	Stainless steel Acciaio inox	DeMastral Brunito DeMastral Brunito	D3	1.520,00
DC406-D1	•	•	Stainless steel Acciaio inox	Satin Satinato	D1	1.590,00
DC406-D8	•	•	Stainless steel Acciaio inox	Lacquered RAL 9010 Laccato RAL 9010	D8	1.420,00

kg 24 kg

kg 25 kg

cm W. 100 D. 100 H. 123 cm

m³ 1,23 m³

N° 1

Excluding VAT
IVA esclusa

Cube

DESIGN BY R&D DE CASTELLI

Cubic cachepot entirely made of metal.

Cachepot cubico interamente realizzato in metallo.

Cube 64
DC147

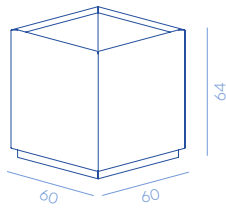

Cube 84
DC111

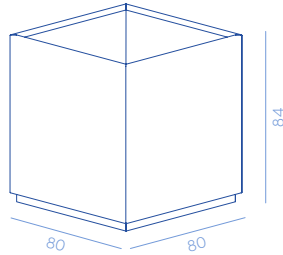

Cube 104
DC112

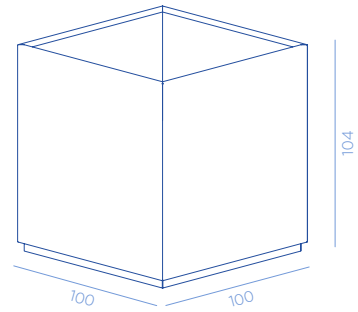

Specify in the order if for indoor or outdoor.

Specificare nell'ordine se per uso interno o esterno.

METAL FINISHES

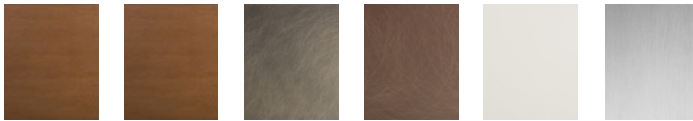

D6

D7

G2

D3

D8

D1

PRODUCT SPECIFICATION

Assembly	Shipped assembled
Packaging	Carton box TYPE E
Details	<ul style="list-style-type: none">- Inner plastic pot included for an indoor use, drainage composites included for outdoor- Equipped with closed base for an indoor use, perforated base for outdoor- The indoor or outdoor use has to be specified at order confirmation- Fixing floor plate available on request

ON REQUEST

Finishes	<ul style="list-style-type: none">- The product can also be made in finishes on request, subject to confirmation of feasibility by De Castelli- Price on request
Dimensions	<ul style="list-style-type: none">- The product can also be custom made in dimensions on request, subject to confirmation of feasibility by De Castelli- Price on request

SPECIFICHE PRODOTTO

Assemblaggio	Spedito montato
Imballo	Scatola in cartone TIPO E
Dettagli	<ul style="list-style-type: none">- Vaso interno incluso per uso interno, sistema di drenaggio incluso per esterno- Caratterizzata da base chiusa per utilizzo interno e base forata per utilizzo esterno- Specificare al momento dell'ordine se per uso interno o esterno- Piastra per fissaggio a terra disponibile su richiesta

SU RICHIESTA

Finiture	<ul style="list-style-type: none">- Il prodotto può essere realizzato anche in finiture su richiesta, previa conferma fattibilità da parte di De Castelli- Prezzo su richiesta
Dimensioni	<ul style="list-style-type: none">- Il prodotto può essere realizzato anche in dimensioni su richiesta, previa conferma fattibilità da parte di De Castelli- Prezzo su richiesta

CUBE 64

W. 60 D. 60 H. 64 cm

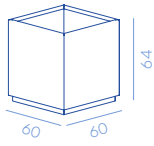

CODE / CODICE	IN	OUT	METAL FINISHES			EURO
DC147-D6		•	Corten Corten	Natural Naturale	D6	1.200,00
DC147-D7	•		Corten Corten	Waxed Cerato	D7	1.340,00
DC147-D8	•	•	Stainless steel Acciaio inox	Lacquered RAL 9010 Laccato RAL 9010	D8	1.680,00
DC147-D3	•	•	Stainless steel Acciaio inox	DeMastral Brunito DeMastral Brunito	D3	1.890,00
DC147-D1	•	•	Stainless steel Acciaio inox	Satin Satinato	D1	2.010,00

kg 26 kg

kg 27 kg

cm W. 65 D. 80 H. 85 cm

m³ 0,45 m³

N² 1

Excluding VAT
IVA esclusa

CUBE 84

W. 80 D. 80 H. 84 cm

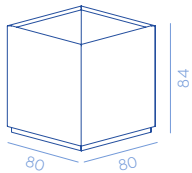

CODE / CODICE	IN	OUT	METAL FINISHES			EURO
DC111-D6		•	Corten Corten	Natural Naturale	D6	1.610,00
DC111-D7	•		Corten Corten	Waxed Cerato	D7	1.740,00
DC111-D8	•	•	Stainless steel Acciaio inox	Lacquered RAL 9010 Laccato RAL 9010	D8	2.210,00
DC111-D3	•	•	Stainless steel Acciaio inox	DeMastral Brunito DeMastral Brunito	D3	2.480,00
DC111-D1	•	•	Stainless steel Acciaio inox	Satin Satinato	D1	2.550,00

kg 49,5 kg

kg 50 kg

cm W. 100 D. 100 H. 105 cm

m³ 1,05 m³

N² 1

Excluding VAT
IVA esclusa

CUBE 104

W. 100 D. 100 H. 104 cm

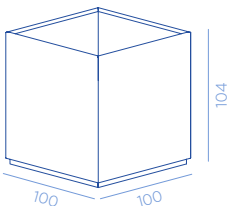

CODE / CODICE	IN	OUT	METAL FINISHES			EURO
DC112-D6		•	Corten Corten	Natural Naturale	D6	2.150,00
DC112-D7	•		Corten Corten	Waxed Cerato	D7	2.280,00
DC112-D8	•	•	Stainless steel Acciaio inox	Lacquered RAL 9010 Laccato RAL 9010	D8	3.250,00
DC112-D3	•	•	Stainless steel Acciaio inox	DeMastral Brunito DeMastral Brunito	D3	3.350,00
DC112-D1	•	•	Stainless steel Acciaio inox	Satin Satinato	D1	3.620,00

kg 74 kg

kg 76 kg

cm W. 105 D. 105 H. 125 cm

m³ 1,40 m³

N² 1

Excluding VAT
IVA esclusa

Dafne & Demetra

DESIGN BY LUDOVICA+ROBERTO PALOMBA

Screens/planters entirely made of laser cut metal. Lighting can be added on request.

Divisorio/fioriera interamente realizzato in metallo tagliato a laser. L'illuminazione è disponibile su richiesta.



Specify in the order if for indoor or outdoor.

Specificare nell'ordine se per uso interno o esterno.

METAL FINISHES



E5

D3

D8

PRODUCT SPECIFICATION

Assembly	Shipped assembled
Packaging	Carton box TYPE E
Details	<ul style="list-style-type: none">- Concret ballast available on request- Equipped with closed base for an indoor use, perforated base for outdoor- The indoor or outdoor use has to be specified at order confirmation
DC000-0025	<ul style="list-style-type: none">- LED kit available on request

ON REQUEST

Finishes	<ul style="list-style-type: none">- The product can also be made in finishes on request, subject to confirmation of feasibility by De Castelli- Price on request
Dimensions	The product is available only in the dimensions listed

SPECIFICHE PRODOTTO

Assemblaggio	Spedito montato
Imballo	Scatola in cartone TIPO E
Dettagli	<ul style="list-style-type: none">- Zavorre disponibili su richiesta- Caratterizzata da base chiusa per utilizzo interno e base forata per utilizzo esterno- Specificare al momento dell'ordine se per uso interno o esterno
DC000-0025	<ul style="list-style-type: none">- LED kit disponibile su richiesta

SU RICHIESTA

Finiture	<ul style="list-style-type: none">- Il prodotto può essere realizzato anche in finiture su richiesta, previa conferma fattibilità da parte di De Castelli- Prezzo su richiesta
Dimensioni	Il prodotto è disponibile solo nelle dimensioni previste

Dafne 170
DC193

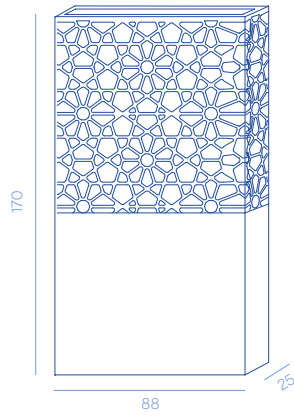

Dafne 210
DC194

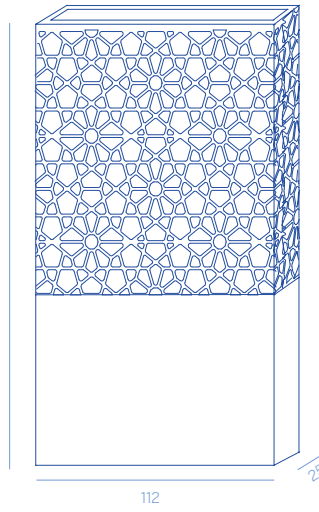

Demetra 170
DC192

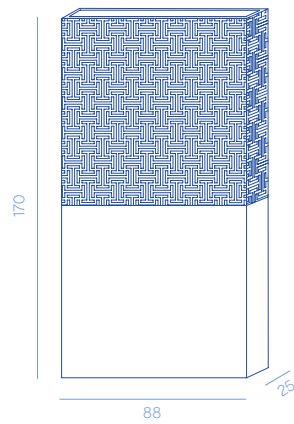

Demetra 210
DC207

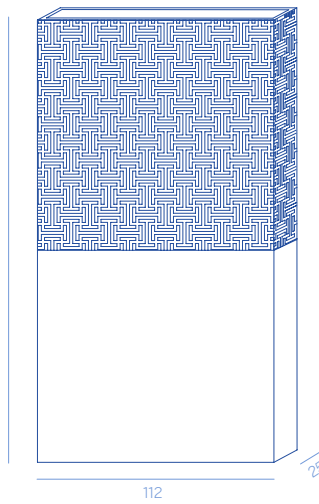

Lighting details / Dettagli illuminazione

CODE / CODICE	VOLTAGE V	FREQ. HZ	POWER W	CLASS	IP	TEMP K°	DIMMABLE
DC000-0025	230V	50/60 HZ	15 W	II	64 PLUG 65 BODY	3000°	NO

DAFNE 170

W. 88 D. 25 H. 170 cm

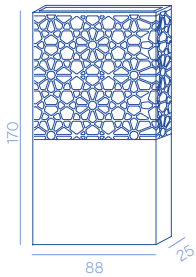

CODE / CODICE	IN	OUT	METAL FINISHES			EURO
DC193-D6		•	Corten Corten	Natural Naturale	D6	2.900,00
DC193-D8	•	•	Stainless steel Acciaio inox	Lacquered RAL 9010 Laccato RAL 9010	D8	2.750,00
DC193-E5	•	•	Stainless steel Acciaio inox	DeLabré B DeLabré B	E5	3.100,00
DC193-D3	•	•	Stainless steel Acciaio inox	DeMastral Brunito DeMastral Brunito	D3	3.250,00

kg 35 kg

kg 42 kg

cm W. 80 D. 120 H. 191 cm

m³ 1,85 m³

N° 1

Excluding VAT
IVA esclusa

DAFNE 210

W. 112 D. 25 H. 210 cm

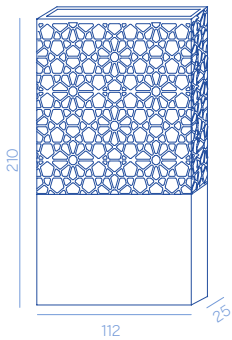

CODE / CODICE	IN	OUT	METAL FINISHES			EURO
DC194-D6		•	Corten Corten	Natural Naturale	D6	2.700,00
DC194-D8	•	•	Stainless steel Acciaio inox	Lacquered RAL 9010 Laccato RAL 9010	D8	3.500,00
DC194-E5	•	•	Stainless steel Acciaio inox	DeLabré B DeLabré B	E5	3.750,00
DC194-D3	•	•	Stainless steel Acciaio inox	DeMastral Brunito DeMastral Brunito	D3	3.900,00

kg 50 kg

kg 60 kg

cm W. 80 D. 150 H. 231 cm

m³ 2,80 m³

N° 1

Excluding VAT
IVA esclusa

DAFNE KIT

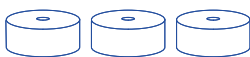
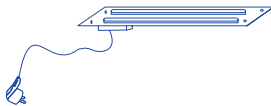

CODE / CODICE	IN	OUT	METAL FINISHES			EURO
DC000-0025	•		230 V 50/60 Hz - 15W LED IP65 BODY - IP44 PLUG			650,00
			Set zavorre/3 pezzi 2,5kg cad. per stabilità lampada	Concrete Ballast set (3 pcs 2,5 kg each) for lamp stability		70,00

Excluding VAT
IVA esclusa

DEMETRA 170

W. 88 D. 25 H. 170 cm

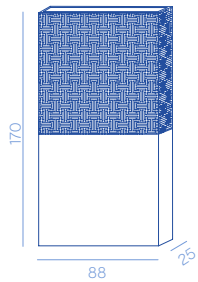

CODE / CODICE	IN	OUT	METAL FINISHES			EURO
DC192-D6		•	Corten Corten	Natural Naturale	D6	2.460,00
DC192-D8	•	•	Stainless steel Acciaio inox	Lacquered RAL 9010 Laccato RAL 9010	D8	3.000,00
DC192-E5	•	•	Stainless steel Acciaio inox	DeLabré B DeLabré B	E5	3.420,00
DC192-D3	•	•	Stainless steel Acciaio inox	DeMastral Brunito DeMastral Brunito	D3	3.830,00

kg 39 kg

kg 45 kg

cm W. 80 D. 120 H. 191 cm

m³ 1,85 m³

Nº 1

Excluding VAT
IVA esclusa

DEMETRA 210

W. 112 D. 25 H. 210 cm

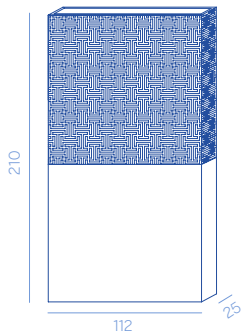

CODE / CODICE	IN	OUT	METAL FINISHES			EURO
DC207-D6		•	Corten Corten	Natural Naturale	D6	2.730,00
DC207-D8	•	•	Stainless steel Acciaio inox	Lacquered RAL 9010 Laccato RAL 9010	D8	3.280,00
DC207-E5	•	•	Stainless steel Acciaio inox	DeLabré B DeLabré B	E5	3.690,00
DC207-D3	•	•	Stainless steel Acciaio inox	DeMastral Brunito DeMastral Brunito	D3	4.100,00

kg 56 kg

kg 66 kg

cm W. 80 D. 150 H. 231 cm

m³ 2,80 m³

Nº 1

Excluding VAT
IVA esclusa

DEMETRA KIT

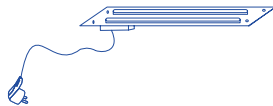

CODE / CODICE	IN	OUT	METAL FINISHES			EURO
DC000-0025	•		230 V 50/60 Hz - 15W LED IP65 BODY - IP44 PLUG			650,00
			Set zavorre/3 pezzi 2,5kg cad. per stabilità lampada	Concrete Ballast set (3 pcs 2,5 kg each) for lamp stability		70,00

Excluding VAT
IVA esclusa

Delta

DESIGN BY ALBINO CELATO

Conical cachepot entirely made of metal.

Cachepot conico interamente realizzato in metallo.

Delta 98
DC087

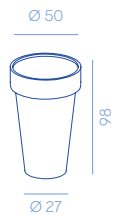

Delta 117
DC086

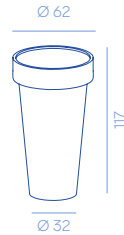

Delta 140
DC085

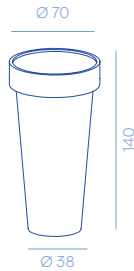

Delta XL 162
DC135

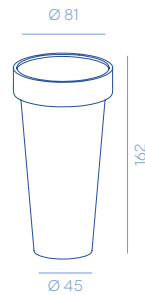

Delta XXL 185
DC134

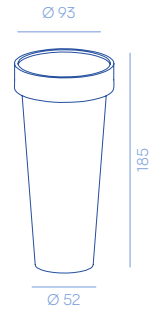

Specify in the order if for indoor or outdoor.

Specificare nell'ordine se per uso interno o esterno.

METAL FINISHES

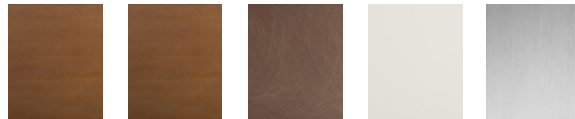

D6

D7

D3

D8

D1

PRODUCT SPECIFICATION

Assembly	Shipped assembled
Packaging	Carton box TYPE E
Details	<ul style="list-style-type: none"> - Inner plastic pot included - Equipped with closed base for an indoor use, perforated base for outdoor - The indoor or outdoor use has to be specified at order confirmation - Fixing floor plate available on request

ON REQUEST

Finishes	<ul style="list-style-type: none"> - The product can also be made in finishes on request, subject to confirmation of feasibility by De Castelli - Price on request
Dimensions	The product is available only in the dimensions listed

SPECIFICHE PRODOTTO

Assemblaggio	Spedito montato
Imballo	Scatola in cartone TIPO E
Dettagli	<ul style="list-style-type: none"> - Vaso interno incluso - Caratterizzata da base chiusa per utilizzo interno e base forata per utilizzo esterno - Specificare al momento dell'ordine se per uso interno o esterno - Piastra per fissaggio a terra disponibile su richiesta

SU RICHIESTA

Finiture	<ul style="list-style-type: none"> - Il prodotto può essere realizzato anche in finiture su richiesta, previa conferma fattibilità da parte di De Castelli - Prezzo su richiesta
Dimensioni	Il prodotto è disponibile solo nelle dimensioni previste

DELTA 98

Ø. 50 Ø. 27 H. 98 cm

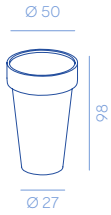

CODE / CODICE	IN	OUT	METAL FINISHES			EURO
DC087-D6		•	Corten Corten	Natural Naturale	D6	888,00
DC087-D7	•		Corten Corten	Waxed Cerato	D7	942,00
DC087-D8	•	•	Stainless steel Acciaio inox	Lacquered RAL 9010 Laccato RAL 9010	D8	1.060,00
DC087-D1	•	•	Stainless steel Acciaio inox	Satin Satinato	D1	1.120,00
DC087-D3	•	•	Stainless steel Acciaio inox	DeMastral Brunito DeMastral Brunito	D3	1.300,00

kg 14 kg

kg 15 kg

cm W. 60 D. 80 H. 119 cm

m³ 0,60 m³

Nº 1

Excluding VAT
IVA esclusa

DELTA 117

Ø. 62 Ø. 32 H. 117 cm

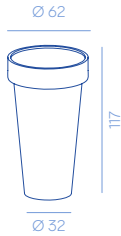

CODE / CODICE	IN	OUT	METAL FINISHES			EURO
DC086-D6		•	Corten Corten	Natural Naturale	D6	1.180,00
DC086-D7	•		Corten Corten	Waxed Cerato	D7	1.230,00
DC086-D8	•	•	Stainless steel Acciaio inox	Lacquered RAL 9010 Laccato RAL 9010	D8	1.370,00
DC086-D1	•	•	Stainless steel Acciaio inox	Satin Satinato	D1	1.400,00
DC086-D3	•	•	Stainless steel Acciaio inox	DeMastral Brunito DeMastral Brunito	D3	1.530,00

kg 20 kg

kg 21 kg

cm W. 60 D. 80 H. 138 cm

m³ 0,66 m³

Nº 1

Excluding VAT
IVA esclusa

DELTA 140

Ø. 70 Ø. 38 H. 140 cm

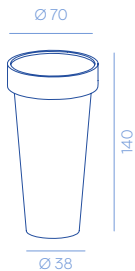

CODE / CODICE	IN	OUT	METAL FINISHES			EURO
DC085-D6		•	Corten Corten	Natural Naturale	D6	1.600,00
DC085-D7	•		Corten Corten	Waxed Cerato	D7	1.740,00
DC085-D8	•	•	Stainless steel Acciaio inox	Lacquered RAL 9010 Laccato RAL 9010	D8	2.090,00
DC085-D1	•	•	Stainless steel Acciaio inox	Satin Satinato	D1	2.370,00
DC085-D3	•	•	Stainless steel Acciaio inox	DeMastral Brunito DeMastral Brunito	D3	2.500,00

kg 26 kg

kg 27 kg

cm W. 60 D. 80 H. 161 cm

m³ 1,55 m³

Nº 1

Excluding VAT
IVA esclusa

DELTA XL 162

Ø. 81 Ø. 45 H. 162 cm

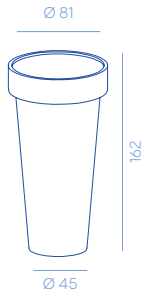

CODE / CODICE	IN	OUT	METAL FINISHES			EURO
DC135-D6		•	Corten Corten	Natural Naturale	D6	2.300,00
DC135-D7	•		Corten Corten	Waxed Cerato	D7	2.370,00
DC135-D8	•	•	Stainless steel Acciaio inox	Lacquered RAL 9010 Laccato RAL 9010	D8	2.780,00
DC135-D1	•	•	Stainless steel Acciaio inox	Satin Satinato	D1	3.060,00
DC135-D3	•	•	Stainless steel Acciaio inox	DeMaistral Brunito DeMaistral Brunito	D3	3.410,00

kg 34 kg

kg 35 kg

cm W. 120 D. 86 H. 183 cm

m³ 1,90 m³

N° 1

Excluding VAT
IVA esclusa

DELTA XXL 186

Ø. 93 Ø. 52 H. 185 cm

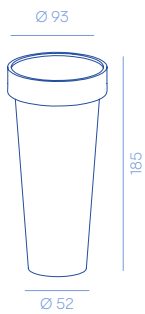

CODE / CODICE	IN	OUT	METAL FINISHES			EURO
DC134-D6		•	Corten Corten	Natural Naturale	D6	2.710,00
DC134-D7	•		Corten Corten	Waxed Cerato	D7	2.780,00
DC134-D8	•	•	Stainless steel Acciaio inox	Lacquered RAL 9010 Laccato RAL 9010	D8	3.200,00
DC134-D1	•	•	Stainless steel Acciaio inox	Satin Satinato	D1	3.615,00
DC134-D3	•	•	Stainless steel Acciaio inox	DeMaistral Brunito DeMaistral Brunito	D3	4.040,00

kg 44,5 kg

kg 46 kg

cm W. 120 D. 98 H. 206 cm

m³ 2,45 m³

N° 1

Excluding VAT
IVA esclusa

Omega

DESIGN BY ALBINO CELATO

Conical cachepot entirely made of metal.

Cachepot conico interamente realizzato in metallo.

Omega 67
DC024



Omega 77
DC023



Omega 90
DC022



Omega XL 104
DC137



Omega XXL 119
DC136



Specify in the order if for indoor or outdoor.

Specificare nell'ordine se per uso interno o esterno.

METAL FINISHES

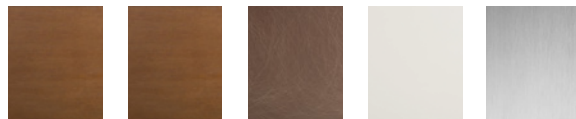

D6

D7

D3

D8

D1

PRODUCT SPECIFICATION

Assembly	Shipped assembled
Packaging	Carton box TYPE E
Details	<ul style="list-style-type: none"> - Inner plastic pot included - Equipped with closed base for an indoor use, perforated base for outdoor - The indoor or outdoor use has to be specified at order confirmation - Fixing floor plate available on request

ON REQUEST

Finishes	<ul style="list-style-type: none"> - The product can also be made in finishes on request, subject to confirmation of feasibility by De Castelli - Price on request
Dimensions	The product is available only in the dimensions listed

SPECIFICHE PRODOTTO

Assemblaggio	Spedito montato
Imballo	Scatola in cartone TIPO E
Dettagli	<ul style="list-style-type: none"> - Vaso interno incluso - Caratterizzata da base chiusa per utilizzo interno e base forata per utilizzo esterno - Specificare al momento dell'ordine se per uso interno o esterno - Piastra per fissaggio a terra disponibile su richiesta

SU RICHIESTA

Finiture	<ul style="list-style-type: none"> - Il prodotto può essere realizzato anche in finiture su richiesta, previa conferma fattibilità da parte di De Castelli - Prezzo su richiesta
Dimensioni	Il prodotto è disponibile solo nelle dimensioni previste

OMEGA 67

Ø. 50 Ø. 27 H. 67 cm



CODE / CODICE	IN	OUT	METAL FINISHES			EURO
DC024-D6		•	Corten Corten	Natural Naturale	D6	850,00
DC024-D7	•		Corten Corten	Waxed Cerato	D7	910,00
DC024-D8	•	•	Stainless steel Acciaio inox	Lacquered RAL 9010 Laccato RAL 9010	D8	1.020,00
DC024-D1	•	•	Stainless steel Acciaio inox	Satin Satinato	D1	1.080,00
DC024-D3	•	•	Stainless steel Acciaio inox	DeMastral Brunito DeMastral Brunito	D3	1.210,00

kg 8 kg

kg 9 kg

cm W. 60 D. 80 H. 88 cm

m³ 0,45 m³

N° 1

Excluding VAT
IVA esclusa

OMEGA 77

Ø. 82 Ø. 32 H. 77 cm



CODE / CODICE	IN	OUT	METAL FINISHES			EURO
DC023-D6		•	Corten Corten	Natural Naturale	D6	930,00
DC023-D7	•		Corten Corten	Waxed Cerato	D7	990,00
DC023-D8	•	•	Stainless steel Acciaio inox	Lacquered RAL 9010 Laccato RAL 9010	D8	1.080,00
DC023-D1	•	•	Stainless steel Acciaio inox	Satin Satinato	D1	1.150,00
DC023-D3	•	•	Stainless steel Acciaio inox	DeMastral Brunito DeMastral Brunito	D3	1.430,00

kg 12,5 kg

kg 13,5 kg

cm W. 100 D. 100 H. 98 cm

m³ 1,00 m³

N° 1

Excluding VAT
IVA esclusa

OMEGA 90

Ø. 70 Ø. 38 H. 90 cm



CODE / CODICE	IN	OUT	METAL FINISHES			EURO
DC022-D6		•	Corten Corten	Natural Naturale	D6	1.060,00
DC022-D7	•		Corten Corten	Waxed Cerato	D7	1.130,00
DC022-D8	•	•	Stainless steel Acciaio inox	Lacquered RAL 9010 Laccato RAL 9010	D8	1.265,00
DC022-D1	•	•	Stainless steel Acciaio inox	Satin Satinato	D1	1.390,00
DC022-D3	•	•	Stainless steel Acciaio inox	DeMastral Brunito DeMastral Brunito	D3	1.520,00

kg 22,5 kg

kg 23,5 kg

cm W. 100 D. 100 H. 111 cm

m³ 1,11 m³

N° 1

Excluding VAT
IVA esclusa

OMEGA XL 104

Ø. 81 Ø. 45 H. 104 cm

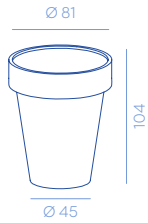

CODE / CODICE	IN	OUT	METAL FINISHES			EURO
DC137-D6		•	Corten Corten	Natural Naturale	D6	1.650,00
DC137-D7	•		Corten Corten	Waxed Cerato	D7	1.790,00
DC137-D8	•	•	Stainless steel Acciaio inox	Lacquered RAL 9010 Laccato RAL 9010	D8	2.150,00
DC137-D1	•	•	Stainless steel Acciaio inox	Satin Satinato	D1	2.440,00
DC137-D3	•	•	Stainless steel Acciaio inox	DeMastral Brunito DeMastral Brunito	D3	2.720,00

kg 25 kg

kg 26 kg

cm W. 85 D. 120 H. 125 cm

m³ 1,30 m³

N° 1

Excluding VAT
IVA esclusa

OMEGA XXL 119

Ø. 93 Ø. 52 H. 119 cm

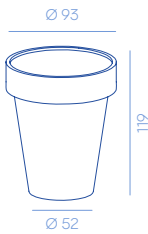

CODE / CODICE	IN	OUT	METAL FINISHES			EURO
DC136-D6		•	Corten Corten	Natural Naturale	D6	1.940,00
DC136-D7	•		Corten Corten	Waxed Cerato	D7	2.080,00
DC136-D8	•	•	Stainless steel Acciaio inox	Lacquered RAL 9010 Laccato RAL 9010	D8	2.580,00
DC136-D1	•	•	Stainless steel Acciaio inox	Satin Satinato	D1	2.860,00
DC136-D3	•	•	Stainless steel Acciaio inox	DeMastral Brunito DeMastral Brunito	D3	2.940,00

kg 33 kg

kg 35 kg

cm W. 100 D. 100 H. 140 cm

m³ 1,40 m³

N° 1

Excluding VAT
IVA esclusa

Narnya

DESIGN BY R&D DE CASTELLI

Conical cachepot entirely made of metal.

Cachepot conico interamente realizzato in metallo.

Narnya 100
DC105

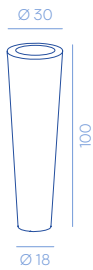

Narnya 120
DC104

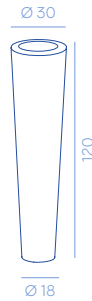

Narnya 140
DC103

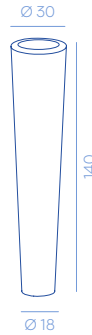

Narnya 160
DC298

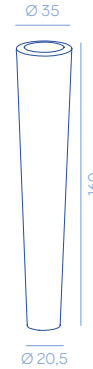

Narnya 185
DC299

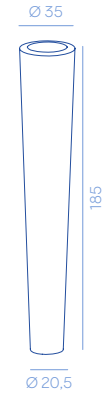

Specify in the order if for indoor or outdoor.

Specificare nell'ordine se per uso interno o esterno.

METAL FINISHES

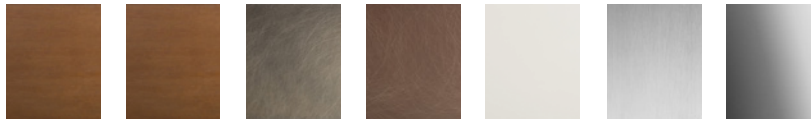

D6

D7

G2

D3

D8

D1

D2

PRODUCT SPECIFICATION

Assembly	Shipped assembled
Packaging	Carton box TYPE E
Details	<ul style="list-style-type: none"> - Inner plastic pot included - Equipped with closed base for an indoor use, perforated base for outdoor - The indoor or outdoor use has to be specified at order confirmation - Fixing floor plate available on request

SPECIFICHE PRODOTTO

Assemblaggio	Spedito montato
Imballo	Scatola in cartone TIPO E
Dettagli	<ul style="list-style-type: none"> - Vaso interno incluso - Caratterizzata da base chiusa per utilizzo interno e base forata per utilizzo esterno - Specificare al momento dell'ordine se per uso interno o esterno - Piastra per fissaggio a terra disponibile su richiesta

ON REQUEST

Finishes	<ul style="list-style-type: none"> - The product can also be made in finishes on request, subject to confirmation of feasibility by De Castelli - Price on request
Dimensions	<ul style="list-style-type: none"> - The product can also be custom made in dimensions on request, subject to confirmation of feasibility by De Castelli - Price on request

SU RICHIESTA

Finiture	<ul style="list-style-type: none"> - Il prodotto può essere realizzato anche in finiture su richiesta, previa conferma fattibilità da parte di De Castelli - Prezzo su richiesta
Dimensioni	<ul style="list-style-type: none"> - Il prodotto può essere realizzato anche in dimensioni su richiesta, previa conferma fattibilità da parte di De Castelli - Prezzo su richiesta

NARNYA 100

Ø. 30 Ø. 18 H. 100 cm

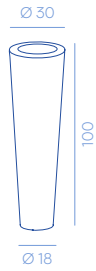

CODE / CODICE	IN	OUT	METAL FINISHES			EURO
DC105-D6		•	Corten Corten	Natural Naturale	D6	730,00
DC105-D7	•		Corten Corten	Waxed Cerato	D7	830,00
DC105-D8	•	•	Stainless steel Acciaio inox	Lacquered RAL 9010 Laccato RAL 9010	D8	710,00
DC105-D1	•	•	Stainless steel Acciaio inox	Satin Satinato	D1	810,00
DC105-D3	•	•	Stainless steel Acciaio inox	DeMaistral Brunito DeMaistral Brunito	D3	930,00
DC105-G2	•	•	Stainless steel Acciaio inox	Orbitale DeLabré DeLabré Orbitale	G2	990,00
DC105-D2	•	•	Stainless steel Acciaio inox	Polished Lucido	D2	1.590,00

kg 11,5 kg

kg 12,5 kg

cm W. 60 D. 80 H. 121 cm

m³ 0,60 m³

Nº 1

Excluding VAT
IVA esclusa

NARNYA 120

Ø. 30 Ø. 18 H. 120 cm

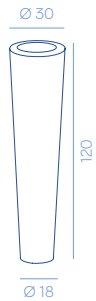

CODE / CODICE	IN	OUT	METAL FINISHES			EURO
DC104-D6		•	Corten Corten	Natural Naturale	D6	760,00
DC104-D7	•		Corten Corten	Waxed Cerato	D7	830,00
DC104-D8	•	•	Stainless steel Acciaio inox	Lacquered RAL 9010 Laccato RAL 9010	D8	830,00
DC104-D1	•	•	Stainless steel Acciaio inox	Satin Satinato	D1	810,00
DC104-D3	•	•	Stainless steel Acciaio inox	DeMaistral Brunito DeMaistral Brunito	D3	990,00
DC104-G2	•	•	Stainless steel Acciaio inox	Orbitale DeLabré DeLabré Orbitale	G2	1.100,00
DC104-D2	•	•	Stainless steel Acciaio inox	Polished Lucido	D2	1.680,00

kg 12 kg

kg 13 kg

cm W. 60 D. 80 H. 141 cm

m³ 0,70 m³

Nº 1

Excluding VAT
IVA esclusa

NARNYA 140

Ø. 30 Ø. 18 H. 140 cm

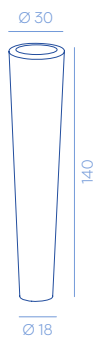

CODE / CODICE	IN	OUT	METAL FINISHES			EURO
DC103-D6		•	Corten Corten	Natural Naturale	D6	800,00
DC103-D7	•		Corten Corten	Waxed Cerato	D7	860,00
DC103-D8	•	•	Stainless steel Acciaio inox	Lacquered RAL 9010 Laccato RAL 9010	D8	830,00
DC103-D1	•	•	Stainless steel Acciaio inox	Satin Satinato	D1	1.040,00
DC103-D3	•	•	Stainless steel Acciaio inox	DeMaistral Brunito DeMaistral Brunito	D3	1.100,00
DC103-G2	•	•	Stainless steel Acciaio inox	Orbitale DeLabré DeLabré Orbitale	G2	1.240,00
DC103-D2	•	•	Stainless steel Acciaio inox	Polished Lucido	D2	1.760,00

kg 13 kg

kg 14 kg

cm W. 80 D. 120 H. 161 cm

m³ 1,55 m³

Nº 1

Excluding VAT
IVA esclusa

NARNYA 160

Ø. 35 Ø. 20,5 H. 160 cm

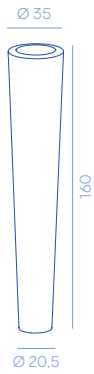

CODE / CODICE	IN	OUT	METAL FINISHES			EURO
DC298-D6		•	Corten Corten	Natural Naturale	D6	1.150,00
DC298-D7	•		Corten Corten	Waxed Cerato	D7	1.220,00
DC298-D8	•	•	Stainless steel Acciaio inox	Lacquered RAL 9010 Laccato RAL 9010	D8	1.220,00
DC298-D1	•	•	Stainless steel Acciaio inox	Satin Satinato	D1	1.500,00
DC298-D3	•	•	Stainless steel Acciaio inox	DeMaistral Brunito DeMaistral Brunito	D3	1.360,00
DC298-G2	•	•	Stainless steel Acciaio inox	Orbitale DeLabré DeLabré Orbitale	G2	1.580,00

kg 14 kg

kg 15 kg

cm W. 80 D. 120 H. 181 cm

m³ 1,75 m³

N° 1

Excluding VAT
IVA esclusa

NARNYA 185

Ø. 35 Ø. 20,5 H. 185 cm

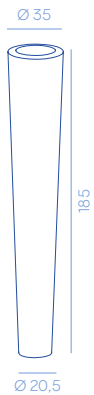

CODE / CODICE	IN	OUT	METAL FINISHES			EURO
DC299-D6		•	Corten Corten	Natural Naturale	D6	1.290,00
DC299-D7	•		Corten Corten	Waxed Cerato	D7	1.360,00
DC299-D8	•	•	Stainless steel Acciaio inox	Lacquered RAL 9010 Laccato RAL 9010	D8	1.360,00
DC299-D1	•	•	Stainless steel Acciaio inox	Satin Satinato	D1	1.720,00
DC299-D3	•	•	Stainless steel Acciaio inox	DeMaistral Brunito DeMaistral Brunito	D3	1.720,00
DC299-G2	•	•	Stainless steel Acciaio inox	Orbitale DeLabré DeLabré Orbitale	G2	1.930,00

kg 15 kg

kg 16 kg

cm W. 80 D. 120 H. 206 cm

m³ 2,00 m³

N° 1

Excluding VAT
IVA esclusa

DESIGN BY JOHANNES KLEIN

Cachepot composed of two cylindrical overlapping elements entirely made of metal.

Cachepot composto da due elementi cilindrici sovrapposti interamente realizzati in metallo.

Phil 44
DC484

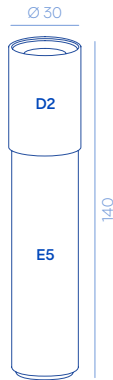

Phil 62
DC485

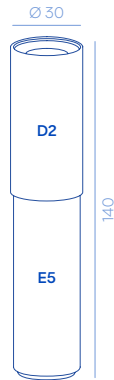

Phil 77
DC486

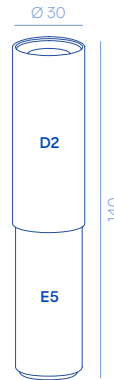

D2 Polished stainless steel
Acciaio inox lucido

E5 DeLabré B stainless steel
Acciaio inox DeLabré B



Specify in the order if for indoor or outdoor.

Specificare nell'ordine se per uso interno o esterno.

METAL FINISHES

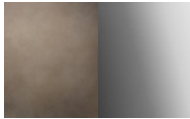

E5 + D2

PRODUCT SPECIFICATION

Assembly	Shipped assembled
Packaging	Carton box TYPE E
Details	<ul style="list-style-type: none"> – Inner plastic pot included – Equipped with closed base for an indoor use, perforated base for outdoor – The indoor or outdoor use has to be specified at order confirmation – Fixing floor plate available on request

ON REQUEST

Finishes	<ul style="list-style-type: none"> – The product can also be made in finishes on request, subject to confirmation of feasibility by De Castelli – Price on request
Dimensions	The product is available only in the dimensions listed

SPECIFICHE PRODOTTO

Assemblaggio	Spedito montato
Imballo	Scatola in cartone TIPO E
Dettagli	<ul style="list-style-type: none"> – Vaso interno incluso – Caratterizzata da base chiusa per utilizzo interno e base forata per utilizzo esterno – Specificare al momento dell'ordine se per uso interno o esterno – Piastra per fissaggio a terra disponibile su richiesta

SU RICHIESTA

Finiture	<ul style="list-style-type: none"> – Il prodotto può essere realizzato anche in finiture su richiesta, previa conferma fattibilità da parte di De Castelli – Prezzo su richiesta
Dimensioni	Il prodotto è disponibile solo nelle dimensioni previste

PHIL 44

Ø. 30 H. 140 cm

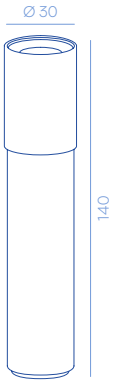

CODE / CODICE	IN	OUT	METAL FINISHES			EURO
DC484-E5-D2	•	•	Stainless steel Acciaio inox	DeLabré B DeLabré B	E5	1.500,00
			Stainless steel Acciaio inox	Polished Lucido	D2	

kg 12 kg
 kg 13,5 kg
 cm W. 60 D. 80 H. 161 cm
 m³ 0,80 m³
 Nº 1
 Excluding VAT
IVA esclusa

PHIL 62

Ø. 30 H. 140 cm

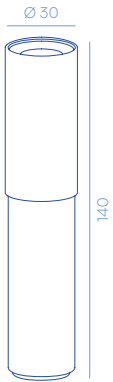

CODE / CODICE	IN	OUT	METAL FINISHES			EURO
DC485-E5-D2	•	•	Stainless steel Acciaio inox	DeLabré B DeLabré B	E5	1.570,00
			Stainless steel Acciaio inox	Polished Lucido	D2	

kg 12,5 kg
 kg 13,5 kg
 cm W. 60 D. 80 H. 161 cm
 m³ 0,80 m³
 Nº 1
 Excluding VAT
IVA esclusa

PHIL 77

Ø. 30 H. 140 cm

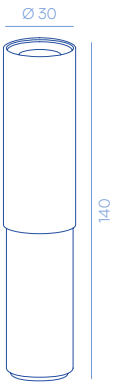

CODE / CODICE	IN	OUT	METAL FINISHES			EURO
DC486-E5-D2	•	•	Stainless steel Acciaio inox	DeLabré B DeLabré B	E5	1.630,00
			Stainless steel Acciaio inox	Polished Lucido	D2	

kg 12,5 kg
 kg 13,5 kg
 cm W. 60 D. 80 H. 161 cm
 m³ 0,80 m³
 Nº 1
 Excluding VAT
IVA esclusa

Riviera Pots

DESIGN BY ALDO CIBIC

Minimalist cachepot with tubular structure entirely made of metal.

Cachepot minimalista con struttura tubolare interamente realizzata in metallo.

Riviera 1 flower 60
DC167

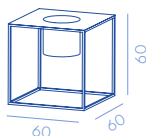

Riviera 1 flower 90
DC161

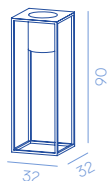

Riviera 3 flowers 50
DC165

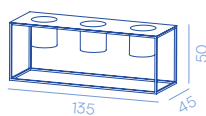

Riviera 3 flowers 90
DC162

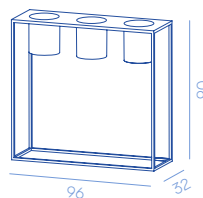

Riviera 5 flowers 90
DC163

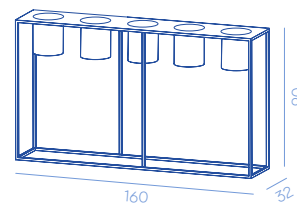

Specify in the order if for indoor or outdoor.

Specificare nell'ordine se per uso interno o esterno.

METAL FINISHES

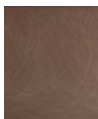

D3

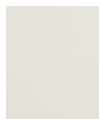

D8

PRODUCT SPECIFICATION

Assembly	Shipped assembled
Packaging	Carton box TYPE E
Details	<ul style="list-style-type: none"> - Inner plastic pot included - Equipped with closed base for an indoor use, perforated base for outdoor - The indoor or outdoor use has to be specified at order confirmation

SPECIFICHE PRODOTTO

Assemblaggio	Spedito montato
Imballo	Scatola in cartone TIPO E
Dettagli	<ul style="list-style-type: none"> - Vaso interno incluso - Caratterizzata da base chiusa per utilizzo interno e base forata per utilizzo esterno - Specificare al momento dell'ordine se per uso interno o esterno

ON REQUEST

Finishes	<ul style="list-style-type: none"> - The product can also be made in finishes on request, subject to confirmation of feasibility by De Castelli - Price on request
Dimensions	The product can also be custom made in dimensions on request, subject to confirmation of feasibility by De Castelli

SU RICHIESTA

Finiture	<ul style="list-style-type: none"> - Il prodotto può essere realizzato anche in finiture su richiesta, previa conferma fattibilità da parte di De Castelli - Prezzo su richiesta
Dimensioni	Il prodotto può essere realizzato anche in dimensioni su richiesta, previa conferma fattibilità da parte di De Castelli

RIVIERA 1 FLOWER 60

W. 60 D. 60 H. 60 cm

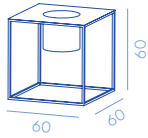

CODE / CODICE	IN	OUT	METAL FINISHES			EURO
DC167-D8	•	•	Stainless steel Acciaio inox	Lacquered RAL 9010 Laccato RAL 9010	D8	1.690,00
DC167-D3	•	•	Stainless steel Acciaio inox	DeMastral Brunito DeMastral Brunito	D3	1.920,00

kg 17 kg
 kg 18 kg
 cm W. 65 D. 80 H. 81 cm
 m³ 0,45 m³
 N° 1
 Excluding VAT
IVA esclusa

RIVIERA 1 FLOWER 90

W. 32 D. 32 H. 90 cm

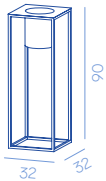

CODE / CODICE	IN	OUT	METAL FINISHES			EURO
DC161-D8	•	•	Stainless steel Acciaio inox	Lacquered RAL 9010 Laccato RAL 9010	D8	1.040,00
DC161-D3	•	•	Stainless steel Acciaio inox	DeMastral Brunito DeMastral Brunito	D3	1.270,00

kg 7,5 kg
 kg 8,5 kg
 cm W. 65 D. 80 H. 111 cm
 m³ 0,55 m³
 N° 1
 Excluding VAT
IVA esclusa

RIVIERA 3 FLOWERS 50

W. 135 D. 45 H. 50 cm

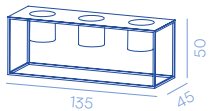

CODE / CODICE	IN	OUT	METAL FINISHES			EURO
DC165-D8	•	•	Stainless steel Acciaio inox	Lacquered RAL 9010 Laccato RAL 9010	D8	2.100,00
DC165-D3	•	•	Stainless steel Acciaio inox	DeMastral Brunito DeMastral Brunito	D3	2.730,00

kg 26,5 kg
 kg 27,5 kg
 cm W. 150 D. 80 H. 71 cm
 m³ 0,85 m³
 N° 1
 Excluding VAT
IVA esclusa

RIVIERA 3 FLOWERS 90

W. 96 D.32 H. 90 cm

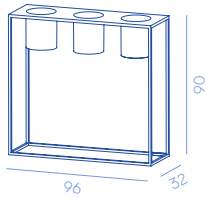

CODE / CODICE	IN	OUT	METAL FINISHES			EURO
DC162-D8	•	•	Stainless steel Acciaio inox	Lacquered RAL 9010 Laccato RAL 9010	D8	1.620,00
DC162-D3	•	•	Stainless steel Acciaio inox	DeMaistral Brunito DeMaistral Brunito	D3	2.200,00

kg 16,5 kg
 kg 17,5 kg
 cm W. 120 D. 80 H. 11 cm
 m² 1,06 m²
 N° 1
 Excluding VAT
IVA esclusa

RIVIERA 5 FLOWERS 90

W. 160 D. 32 H. 90 cm

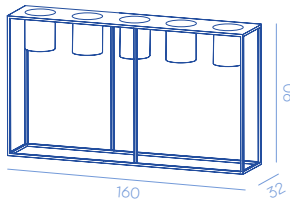

CODE / CODICE	IN	OUT	METAL FINISHES			EURO
DC163-D8	•	•	Stainless steel Acciaio inox	Lacquered RAL 9010 Laccato RAL 9010	D8	2.730,00
DC163-D3	•	•	Stainless steel Acciaio inox	DeMaistral Brunito DeMaistral Brunito	D3	3.280,00

kg 26,5 kg
 kg 27,5 kg
 cm W. 210 D. 80 H. 111 cm
 m² 1,86 m²
 N° 1
 Excluding VAT
IVA esclusa

Rocco

DESIGN BY STEFANO DUSSIN

Decorative vases characterized by a sculptural shape, entirely made of metal.

Vasi decorativi caratterizzati da una forma scultorea, interamente realizzati in metallo.

Rocco 147
DC075



Rocco 175
DC074

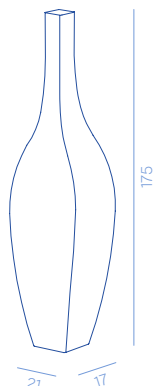

Specify in the order if for indoor or outdoor.

Specificare nell'ordine se per uso interno o esterno.

METAL FINISHES

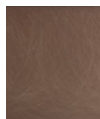

D3

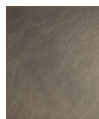

G2



G3

PRODUCT SPECIFICATION

Assembly	Shipped assembled
Packaging	Carton box TYPE E
Details	<ul style="list-style-type: none">- Decorative pot- The indoor or outdoor use has to be specified at order confirmation- Fixing floor plate available on request

ON REQUEST

Finishes	<ul style="list-style-type: none">- The product can also be made in finishes on request, subject to confirmation of feasibility by De Castelli- Price on request
Dimensions	The product is available only in the dimensions listed

SPECIFICHE PRODOTTO

Assemblaggio	Spedito montato
Imballo	Scatola in cartone TIPO E
Dettagli	<ul style="list-style-type: none">- Vaso decorativo- Specificare al momento dell'ordine se per uso interno o esterno- Piastra per fissaggio a terra disponibile su richiesta

SU RICHIESTA

Finiture	<ul style="list-style-type: none">- Il prodotto può essere realizzato anche in finiture su richiesta, previa conferma fattibilità da parte di De Castelli- Prezzo su richiesta
Dimensioni	Il prodotto è disponibile solo nelle dimensioni previste

ROCCO 147

W. 37 D. 25 H. 147 cm

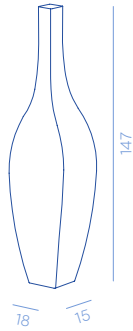

CODE / CODICE	IN	OUT	METAL FINISHES			EURO
DC075-D3	•	•	Stainless steel Acciaio inox	DeMaistral Brunito DeMaistral Brunito	D3	1.610,00
DC075-G2	•	•	Stainless steel Acciaio inox	Orbitale DeLabré DeLabré Orbitale	G2	1.950,00
DC075-G3	•		Brass Ottone	Orbitale DeLabré DeLabré Orbitale	G3	2.490,00

kg 14,7 kg

kg 15,5 kg

cm W. 80 D. 120 H. 168 cm

m³ 1,61 m³

N° 1

Excluding VAT
IVA esclusa

ROCCO 175

W. 44 D. 30 H. 175 cm

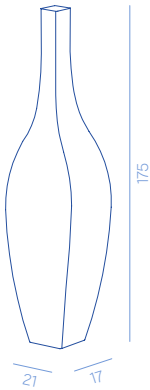

CODE / CODICE	IN	OUT	METAL FINISHES			EURO
DC074-D3	•	•	Stainless steel Acciaio inox	DeMaistral Brunito DeMaistral Brunito	D3	1.650,00
DC074-G2	•	•	Stainless steel Acciaio inox	Orbitale DeLabré DeLabré Orbitale	G2	2.120,00
DC074-G3	•		Brass Ottone	Orbitale DeLabré DeLabré Orbitale	G3	3.150,00

kg 21,8 kg

kg 22,8 kg

cm W. 80 D. 120 H. 196 cm

m³ 1,90 m³

N° 1

Excluding VAT
IVA esclusa

Lolita

DESIGN BY STEFANO DUSSIN

Decorative vases characterized by a sculptural shape, entirely made of metal.

Vasi decorativi caratterizzati da una forma scultorea, interamente realizzati in metallo.

Lolita 118
DC073

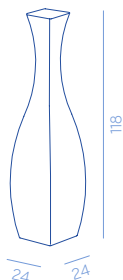

Lolita 140
DC072

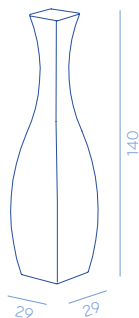

Specify in the order if for indoor or outdoor.

Specificare nell'ordine se per uso interno o esterno.

METAL FINISHES

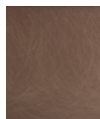

D3

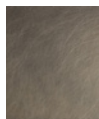

G2



G3

PRODUCT SPECIFICATION

Assembly	Shipped assembled
Packaging	Carton box TYPE E
Details	<ul style="list-style-type: none">- Decorative pot- The indoor or outdoor use has to be specified at order confirmation- Fixing floor plate available on request

ON REQUEST

Finishes	<ul style="list-style-type: none">- The product can also be made in finishes on request, subject to confirmation of feasibility by De Castelli- Price on request
Dimensions	The product is available only in the dimensions listed

SPECIFICHE PRODOTTO

Assemblaggio	Spedito montato
Imballo	Scatola in cartone TIPO E
Dettagli	<ul style="list-style-type: none">- Vaso decorativo- Specificare al momento dell'ordine se per uso interno o esterno- Piastra per fissaggio a terra disponibile su richiesta

SU RICHIESTA

Finiture	<ul style="list-style-type: none">- Il prodotto può essere realizzato anche in finiture su richiesta, previa conferma fattibilità da parte di De Castelli- Prezzo su richiesta
Dimensioni	Il prodotto è disponibile solo nelle dimensioni previste

LOLITA 118

W. 24 D. 24 H. 118 cm

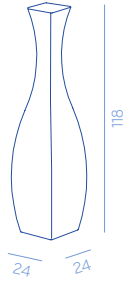

CODE / CODICE	IN	OUT	METAL FINISHES			EURO
DC073-D3	•	•	Stainless steel Acciaio inox	DeMaistral Brunito DeMaistral Brunito	D3	1.580,00
DC073-G2	•	•	Stainless steel Acciaio inox	Orbitale DeLabré DeLabré Orbitale	G2	1.400,00
DC073-G3	•		Brass Ottone	Orbitale DeLabré DeLabré Orbitale	G3	2.120,00

kg 10,7 kg

kg 12 kg

cm W. 80 D. 60 H. 144 cm

m³ 0,70 m³

N° 1

Excluding VAT
IVA esclusa

LOLITA 140

W. 29 D. 29 H. 140 cm

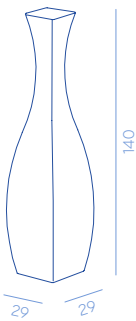

CODE / CODICE	IN	OUT	METAL FINISHES			EURO
DC072-D3	•	•	Stainless steel Acciaio inox	DeMaistral Brunito DeMaistral Brunito	D3	1.850,00
DC072-G2	•	•	Stainless steel Acciaio inox	Orbitale DeLabré DeLabré Orbitale	G2	1.680,00
DC072-G3	•		Brass Ottone	Orbitale DeLabré DeLabré Orbitale	G3	2.380,00

kg 15 kg

kg 16 kg

cm W. 80 D. 60 H. 161 cm

m³ 0,80m³

N° 1

Excluding VAT
IVA esclusa

Screen-Pot

DESIGN BY FRANCOIS CLERC

Decorative cachepot entirely made of metal with laser-cut decorative pattern.

Cachepot decorativo interamente realizzato in metallo con pattern decorativo tagliato a laser.

Screen-Pot 1 Plant
DC402

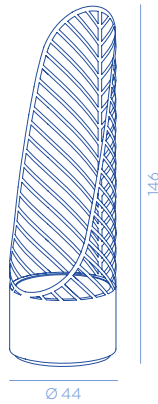

Screen-Pot 2 Plants
DC403

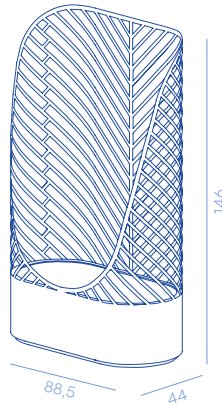

Specify in the order if for indoor or outdoor.

Specificare nell'ordine se per uso interno o esterno.

METAL FINISHES

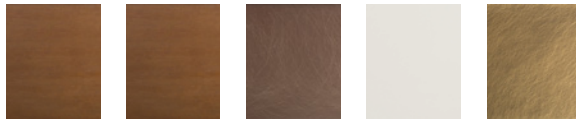

D6

D7

D3

D8

G3

PRODUCT SPECIFICATION

Assembly	Shipped assembled
Packaging	Carton box TYPE E
Details	<ul style="list-style-type: none"> - Inner plastic pot included for an indoor use, drainage composites included for outdoor - Equipped with closed base for an indoor use, perforated base for outdoor - The indoor or outdoor use has to be specified at order confirmation

SPECIFICHE PRODOTTO

Assemblaggio	Spedito montato
Imballo	Scatola in cartone TIPO E
Dettagli	<ul style="list-style-type: none"> - Vaso interno incluso per uso interno, sistema di drenaggio incluso per esterno - Caratterizzata da base chiusa per utilizzo interno e base forata per utilizzo esterno - Specificare al momento dell'ordine se per uso interno o esterno

ON REQUEST

Finishes	<ul style="list-style-type: none"> - The product can also be made in finishes on request, subject to confirmation of feasibility by De Castelli - Price on request
Dimensions	The product is available only in the dimensions listed

SU RICHIESTA

Finiture	<ul style="list-style-type: none"> - Il prodotto può essere realizzato anche in finiture su richiesta, previa conferma fattibilità da parte di De Castelli - Prezzo su richiesta
Dimensioni	Il prodotto è disponibile solo nelle dimensioni previste

SCREEN - POT 1 PLANT

Ø. 44 H. 146 cm

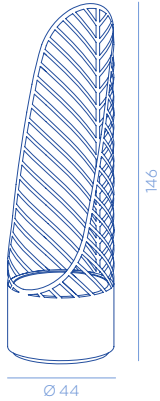

CODE / CODICE	IN	OUT	METAL FINISHES			EURO
DC402-D6		•	Corten Corten	Natural Naturale	D6	1.240,00
DC402-D7	•		Corten Corten	Waxed Cerato	D7	1.290,00
DC402-D8	•	•	Stainless steel Acciaio inox	Lacquered RAL 9010 Laccato RAL 9010	D8	1.600,00
DC402-D3	•	•	Stainless steel Acciaio inox	DeMaistral Brunito DeMaistral Brunito	D3	2.130,00
DC402-G2	•	•	Stainless steel Acciaio inox	Orbitale DeLabré DeLabré Orbitale	G2	2.580,00

kg 15 kg

kg 16 kg

cm W. 60 D. 80 H. 167 cm

m³ 0,80 m³

N° 1

Excluding VAT
IVA esclusa

SCREEN - POT 2 PLANTS

W. 88,5 D. 44 H. 146 cm

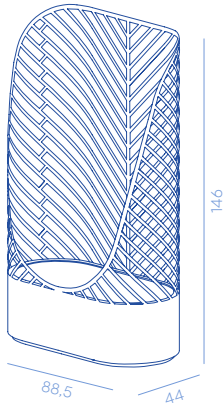

CODE / CODICE	IN	OUT	METAL FINISHES			EURO
DC403-D6		•	Corten Corten	Natural Naturale	D6	2.130,00
DC403-D7	•		Corten Corten	Waxed Cerato	D7	2.190,00
DC403-D8	•	•	Stainless steel Acciaio inox	Lacquered RAL 9010 Laccato RAL 9010	D8	2.510,00
DC403-D3	•	•	Stainless steel Acciaio inox	DeMaistral Brunito DeMaistral Brunito	D3	3.030,00
DC403-G2	•	•	Stainless steel Acciaio inox	Orbitale DeLabré DeLabré Orbitale	G2	3.810,00

kg 27 kg

kg 28 kg

cm W. 120 D. 80 H. 167 cm

m³ 1,60 m³

N° 1

Excluding VAT
IVA esclusa

Shimla & Jaipur

DESIGN BY STEFANO DUSSIN

Decorative vases characterized by a sculptural shape, entirely made of metal.

Vasi decorativi caratterizzati da una forma scultorea, interamente realizzati in metallo.

Shimla
DC113

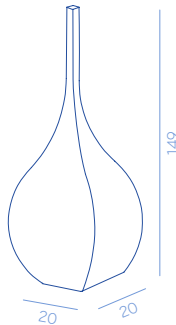

Jaipur 150
DC083

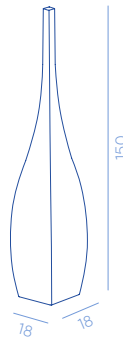

Jaipur 183
DC082

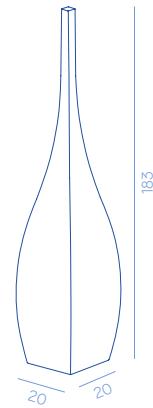

Specify in the order if for indoor or outdoor.

Specificare nell'ordine se per uso interno o esterno.

METAL FINISHES

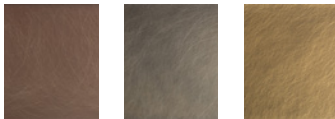

D3

G2

G3

PRODUCT SPECIFICATION

Assembly	Shipped assembled
Packaging	Carton box TYPE E
Details	<ul style="list-style-type: none"> - Decorative pot - The indoor or outdoor use has to be specified at order confirmation - Fixing floor plate available on request

ON REQUEST

Finishes	<ul style="list-style-type: none"> - The product can also be made in finishes on request, subject to confirmation of feasibility by De Castelli - Price on request
Dimensions	The product is available only in the dimensions listed

SPECIFICHE PRODOTTO

Assemblaggio	Spedito montato
Imballo	Scatola in cartone TIPO E
Dettagli	<ul style="list-style-type: none"> - Vaso decorativo - Specificare al momento dell'ordine se per uso interno o esterno - Piastra per fissaggio a terra disponibile su richiesta

SU RICHIESTA

Finiture	<ul style="list-style-type: none"> - Il prodotto può essere realizzato anche in finiture su richiesta, previa conferma fattibilità da parte di De Castelli - Prezzo su richiesta
Dimensioni	Il prodotto è disponibile solo nelle dimensioni previste

SHIMLA

W. 50,5 D. 50,5 H. 149 cm

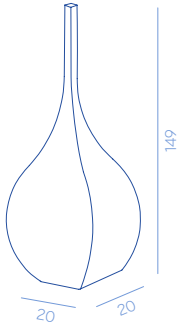

CODE / CODICE	IN	OUT	METAL FINISHES			EURO
DC113-D3	•	•	Stainless steel Acciaio inox	DeMaistral Brunito DeMaistral Brunito	D3	2.070,00
DC113-G2	•	•	Stainless steel Acciaio inox	Orbitale DeLabré DeLabré Orbitale	G2	2.310,00
DC113-G3	•		Brass Ottone	Orbitale DeLabré DeLabré Orbitale	G3	3.270,00

kg 18 kg

kg 19 kg

cm W. 60 D. 80 H. 170 cm

m³ 0,81 m³

N° 1

Excluding VAT
IVA esclusa

JAIPUR 150

W. 32 D. 32 H. 150 cm

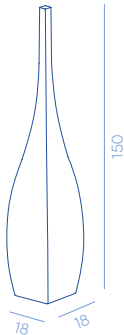

CODE / CODICE	IN	OUT	METAL FINISHES			EURO
DC083-D3	•	•	Stainless steel Acciaio inox	DeMaistral Brunito DeMaistral Brunito	D3	1.490,00
DC083-G2	•	•	Stainless steel Acciaio inox	Orbitale DeLabré DeLabré Orbitale	G2	1.550,00
DC083-G3	•		Brass Ottone	Orbitale DeLabré DeLabré Orbitale	G3	2.270,00

kg 12,7 kg

kg 13,5 kg

cm W. 60 D. 80 H. 171 cm

m³ 0,82 m³

N° 1

Excluding VAT
IVA esclusa

JAIPUR 183

W. 34 D. 34 H. 183 cm

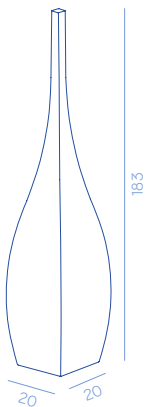

CODE / CODICE	IN	OUT	METAL FINISHES			EURO
DC082-D3	•	•	Stainless steel Acciaio inox	DeMaistral Brunito DeMaistral Brunito	D3	1.670,00
DC082-G2	•	•	Stainless steel Acciaio inox	Orbitale DeLabré DeLabré Orbitale	G2	1.990,00
DC082-G3	•		Brass Ottone	Orbitale DeLabré DeLabré Orbitale	G3	2.630,00

kg 16,5 kg

kg 17,5 kg

cm W. 60 D. 80 H. 204 cm

m³ 1,00 m³

N° 1

Excluding VAT
IVA esclusa

Tristan & Isotte

DESIGN BY R&D DE CASTELLI

Decorative vases characterized by a sculptural shape, entirely made of metal.

Vasi decorativi caratterizzati da una forma scultorea, interamente realizzati in metallo.

Tristan
DC099

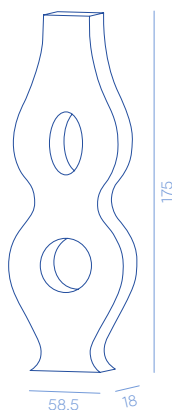

Isotte
DC098

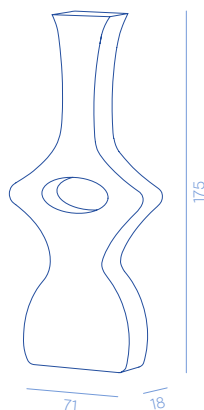

Specify in the order if for indoor or outdoor.

Specificare nell'ordine se per uso interno o esterno.

METAL FINISHES



D3

PRODUCT SPECIFICATION

Assembly	Shipped assembled
Packaging	Carton box TYPE E
Details	<ul style="list-style-type: none">- Decorative pot- Equipped with closed top for outdoor use- The indoor or outdoor use has to be specified at order confirmation- Fixing floor plate available on request

ON REQUEST

Finishes	<ul style="list-style-type: none">- The product can also be made in finishes on request, subject to confirmation of feasibility by De Castelli- Price on request
Dimensions	The product is available only in the dimensions listed

SPECIFICHE PRODOTTO

Assemblaggio	Spedito montato
Imballo	Scatola in cartone TIPO E
Dettagli	<ul style="list-style-type: none">- Vaso decorativo- Caratterizzato dal top chiuso per uso esterno- Specificare al momento dell'ordine se per uso interno o esterno- Piastra per fissaggio a terra disponibile su richiesta

SU RICHIESTA

Finiture	<ul style="list-style-type: none">- Il prodotto può essere realizzato anche in finiture su richiesta, previa conferma fattibilità da parte di De Castelli- Prezzo su richiesta
Dimensioni	Il prodotto è disponibile solo nelle dimensioni previste

TRISTAN

W. 60 D. 18 H. 175 cm

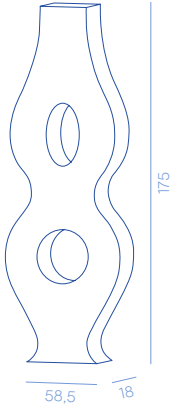

CODE / CODICE	IN	OUT	METAL FINISHES			EURO
DC099-D3	•	•	Stainless steel Acciaio inox	DeMaistral Brunito DeMaistral Brunito	D3	2.660,00

kg 27 kg
kg 30 kg
cm >
cm W. 60 D. 80 H. 171960 cm
m³ 0,95 m³
Nº 1
Excluding VAT IVA esclusa

ISOTTE

W. 71 D. 18 H. 175 cm

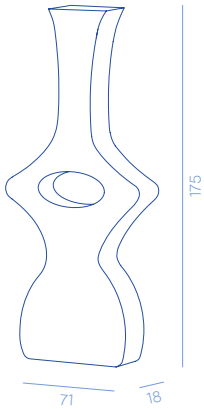

CODE / CODICE	IN	OUT	METAL FINISHES			EURO
DC098-D3	•	•	Stainless steel Acciaio inox	DeMaistral Brunito DeMaistral Brunito	D3	2.660,00

kg 26,5 kg
kg 29 kg
cm >
cm W. 60 D. 80 H. 196 cm
m³ 0,95 m³
Nº 1
Excluding VAT IVA esclusa

FIXING PLATE

Ø 18 H. 7 cm

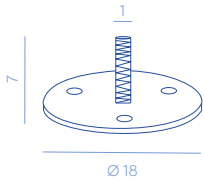

CODE / CODICE	IN	OUT	MATERIAL / MATERIALE	EURO
DCFIS-01		•	Ground fixing plate pots Piastra per fissaggio vasi terra	260,00

kg 0,5 kg

kg 0,7 kg

cm W.20 D.20 H.15 cm

m³ 0,01 m³

N° 1

Excluding VAT
IVA esclusa

Landscape

Cottage N.1

DESIGN BY FILIPPO PISAN

Hut/garden shed in wood clad in corten, equipped with internal shelves.

Casetta/ripostiglio da giardino in legno rivestita in corten, attrezzata con mensole interne.

Cottage N.1
DC420

Internal measurements / Misure interne

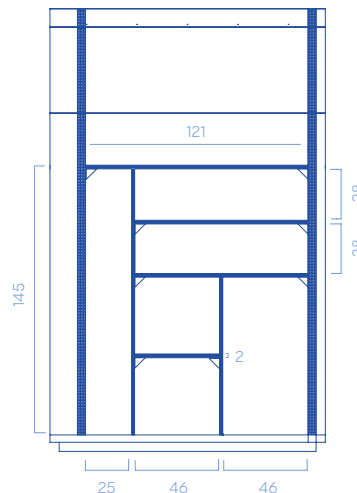
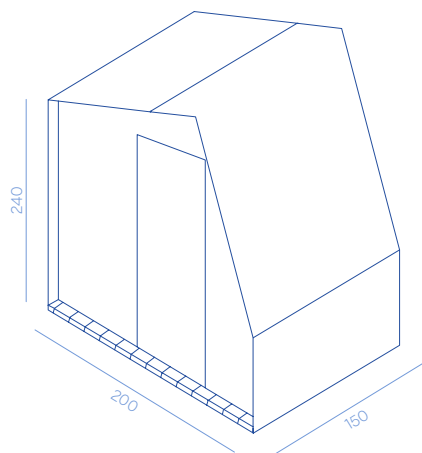

METAL FINISHES

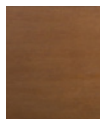

D6

PRODUCT SPECIFICATION

Wall, floor and shelves	Bleached fir wood treated for outdoor 
Assembly	Shipped disassembled
Packaging	Wooden crate included
Details	<ul style="list-style-type: none">- Hut/garden shed equipped with internal shelves- Door with key and lock- Earthing and electrical system available on request

SPECIFICHE PRODOTTO

Parete, pavimento e mensole	Legno di abete sbiancato trattato per esterno 
Assemblaggio	Spedito smontato
Imballo	Imballo in cassa incluso
Dettagli	<ul style="list-style-type: none">- Casetta da giardino attrezzata con ripiani interni- Porta con chiave e serratura- Messa a terra ed impianto elettrico disponibili su richiesta

ON REQUEST

Finishes	The product is available only in the finishes listed
Dimensions	The product is available only in the dimensions listed

SU RICHIESTA

Finiture	Il prodotto è disponibile solo nelle finiture previste
Dimensioni	Il prodotto è disponibile solo nelle dimensioni previste

COTTAGE N1

W. 200 D. 150 H. 240 cm

CODE / CODICE	IN	OUT	METAL FINISHES	EURO
DC420-D6		•	Corten Natural Corten Naturale	D6 14.000,00

OPTIONALS

DC418	Earthing system Sistema messa a terra		500,00
DC419	Earthing system + electrical system Sistema messa a terra + impianto elettrico		1.400,00

 335 kg

 380 kg

 W. 259 D. 209 H. 227 cm

 12,30 m³

 1

Excluding VAT
IVA esclusa

Dog House N.1

DESIGN BY FILIPPO PISAN

Outdoor dog house in wood clad in corten.

Cuccia per cani da esterno in legno rivestita in corten.

Dog House N.1
DC421

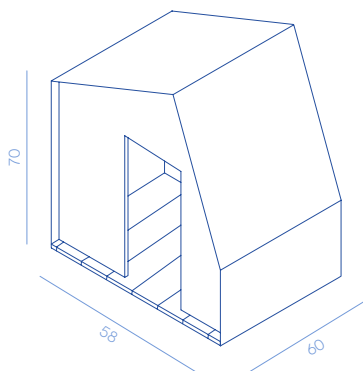

METAL FINISHES

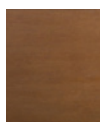

D6

PRODUCT SPECIFICATION

Wall, floor and shelves Bleached fir wood treated for outdoor



Assembly Shipped assembled

Packaging Carton box [TYPE E](#)

Details – Outdoor dog house in wood clad in corten

SPECIFICHE PRODOTTO

Parete, pavimento e mensole Legno di abete sbiancato trattato per esterno



Assemblaggio Spedito montato

Imballo Scatola in cartone [TIPO E](#)

Dettagli – Cuccia per cani da esterno in legno e rivestita in corten

ON REQUEST

Finishes The product is available only in the finishes listed

Dimensions The product is available only in the dimensions listed

SU RICHIESTA

Finiture Il prodotto è disponibile solo nelle finiture previste

Dimensioni Il prodotto è disponibile solo nelle dimensioni previste

DOG HOUSE N.1

W. 58 D. 60 H. 70 cm

CODE / CODICE	IN	OUT	METAL FINISHES	EURO
DC421-D6		•	Corten Natural Corten Naturale	D6 2.200,00

 35,5 kg

 45 kg

 W. 65 D. 80 H. 97 cm

 0,50m³

 1

Excluding VAT
IVA esclusa

Nest House N.1

DESIGN BY R&D DE CASTELLI

Birdhouse in wood clad in corten.

Nido da giardino in legno rivestito in corten.

Nest House N.1
DC422

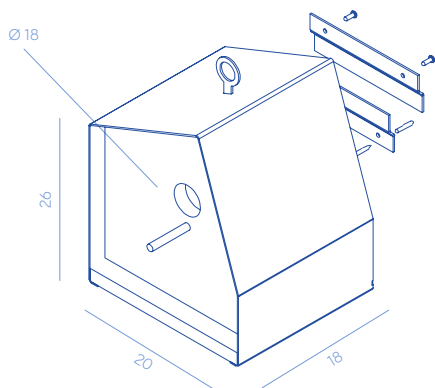

METAL FINISHES

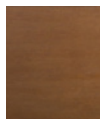

D6

PRODUCT SPECIFICATION

Wall, floor and shelves Bleached fir wood treated for outdoor



Assembly Shipped assembled

Packaging Carton box [TYPE E](#)

Details – Outdoor birdhouse in wood clad in corten

SPECIFICHE PRODOTTO

Parete, pavimento e mensole Legno di abete sbiancato trattato per esterno



Assemblaggio Spedito montato

Imballo Scatola in cartone [TIPO E](#)

Dettagli – Casa per uccellini da esterno in legno rivestito in corten

ON REQUEST

Finishes The product is available only in the finishes listed

Dimensions The product is available only in the dimensions listed

SU RICHIESTA

Finiture Il prodotto è disponibile solo nelle finiture previste

Dimensioni Il prodotto è disponibile solo nelle dimensioni previste

NEST N 1

W. 20 D. 18 H. 26 cm

CODE / CODICE	IN	OUT	METAL FINISHES	EURO
DC422-D6		•	Corten Natural Corten Naturale	D6 720,00

 3 kg

 3,5 kg

 W. 25 D. 25 H. 35 cm

 0,02 m³

 1

Excluding VAT
IVA esclusa

Tiles
Piastrelle

Cipher

DESIGN BY FRANCESCO FORCELLINI

KIT of 4 tiles characterised by a variation of the same shape and by the DeErosion finishing.

KIT di 4 piastrelle caratterizzate da una variante della stessa forma e dalla finitura DeErosion

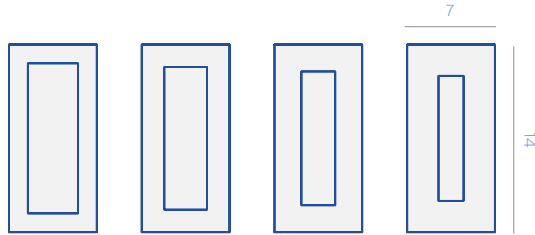

 Each KIT consists of 4 different modules that can not be sold separately Ogni KIT è composto da 4 moduli differenti non vendibili separatamente

PRODUCT SPECIFICATION

Limits	<ul style="list-style-type: none"> – Shower cabin and areas in direct contact with water excluded – Bathroom and kitchen backsplash are not recommended
Details	<ul style="list-style-type: none"> – Elements not sold individually, only in KIT – Minimum order 20 KIT – 24 KIT are required to clad 1 m²
Packaging	<ul style="list-style-type: none"> – Carton box TYPE E – Max 20 KIT each box
Installation	<ul style="list-style-type: none"> – At least 2 mm grout line is required – It can be installed using epoxy adhesives and grouts – It can be processed on site with suitable tools, refer to Installation Manual for procedures and details

SPECIFICHE PRODOTTO

Limits	<ul style="list-style-type: none"> – Escluso box doccia e zone a diretto contatto con l'acqua – Si sconsiglia l'utilizzo in bagno e come paraschizzi della cucina
Dettagli	<ul style="list-style-type: none"> – Elementi non vendibili singolarmente, solo in KIT – Ordine minimo 20 KIT – Per rivestire 1 m² sono necessari 24 KIT
Imballaggio	<ul style="list-style-type: none"> – Scatola di cartone TIPO E – Max 20 KIT per scatola
Installazione	<ul style="list-style-type: none"> – È necessaria una fuga di almeno 2 mm – Può essere installato utilizzando adesivi e stucchi epossidici – Può essere lavorato in cantiere con attrezzi idonei, fare riferimento al Manuale di Installazione per procedure e dettagli

REGULATIONS

	Standard	Requisites	Results
Coeff. di dilatazione termica lineare	ISO 10545-8	from 25°C to 100°C (10-6 °C-1)	17,1 (Copper)
Resistance to chemical products for housekeeping	ISO 10545-13	A - B - C	A
Stain resistance	ISO 10545-14	1 - 5	Test method certificate available on request
Accelerated aging with UV lamp	ASTM G 145-16	Exposure time 500 hours	Gray scale evaluation: 4/5 slight variation in surface gloss and slight variation in color

NORMATIVE

	Standard	Requisites	Results
Coeff. di dilatazione termica lineare	ISO 10545-8	from 25°C to 100°C (10-6 °C-1)	17,1 (Rame)
Resistenza ai prodotti chimici di uso domestico	ISO 10545-13	A - B - C	A
Resistenza alle macchie	ISO 10545-14	1 - 5	Certificato metodo di prova disponibile su richiesta
Invecchiamento accelerato con lampada UV	ASTM G 145-16	Tempo di esposizione 500 ore	Valutazione scala di grigi: 4/5 lieve variazione di lucentezza superficiale e lieve variazione di colore

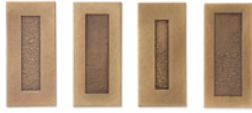

DCS108-KIT-OT

BRASS
OTTONE

CODE / CODICE	IN	OUT	METAL FINISHES	MINIMUM ORDER/ORDINE MINIMO	EURO
DS108-KIT-OT	•		Brass Ottone DeErosion DeErosion OT	20 KIT (80 pieces/pezzi)	350,00 Per KIT Al KIT

0,177 kg/pz
 17 Kg/m²
 1 box = 20 KIT
 15,7 kg
 W. 41 D. 41 H. 9 cm

Excluding VAT
IVA esclusa

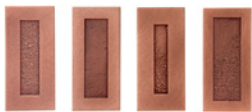

DCS108-KIT-RA

COPPER
RAME

CODE / CODICE	IN	OUT	METAL FINISHES	MINIMUM ORDER/ORDINE MINIMO	EURO
DS108-KIT-RA	•		Copper Rame DeErosion DeErosion RA	20 KIT (80 pieces/pezzi)	370,00 Per KIT Al KIT

0,185x4 kg/pz
 17,8 Kg/m²
 1 box = 20 KIT
 16,3 kg
 W. 41 D. 41 H. 9 cm

Excluding VAT
IVA esclusa

DeErosion

DESIGN BY LEONARDO SONNOLI

Tiles available in 4 DeErosion patterns inspired by graphic and geometric shapes (H4, H6, H7) or organic and natural shapes (H8). Models and finishes can be combined enabling maximum freedom of composition.

Piastrelle disponibili in 4 pattern DeErosion ispirati a forme grafiche e geometriche (H4, H6, H7) o forme organiche e naturali (H8). È possibile combinare modelli e finiture per una massima libertà di composizione.

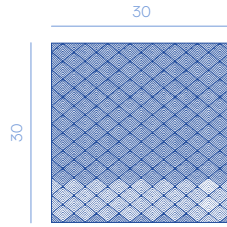

DeErosion H4 MINI
DS107-H4 MINI

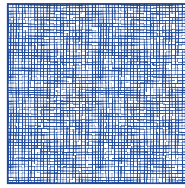

DeErosion H6 MINI
DS107-H6 MINI

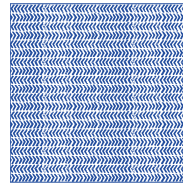

DeErosion H7 MINI
DCS107-H7 MINI

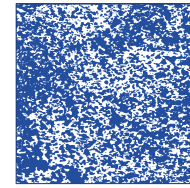

DeErosion H8
DS107-H8



Patterns H4, H6, H7 are MINI, scaled down from standard DeErosion patterns H4, H6, H7

I pattern H4, H6, H7 sono MINI, ridotti in scala rispetto ai pattern DeErosion standard H4, H6, H7

PRODUCT SPECIFICATION

Limits	<ul style="list-style-type: none"> – Shower cabin and areas in direct contact with water excluded – Bathroom and kitchen backsplash are not recommended
Details	<ul style="list-style-type: none"> – H4, H6 and H7 patterns are MINI, reduced in scale than the standard ones – Minimum order 12 tiles – 12 tiles are required to clad 1 m²
Packaging	<ul style="list-style-type: none"> – Carton box TYPE E – Max 12 pieces each box
Installation	<ul style="list-style-type: none"> – At least 2 mm grout line is required – It can be installed using epoxy adhesives and grouts – It can be processed on site with suitable tools, refer to Installation Manual for procedures and details

SPECIFICHE PRODOTTO

Limits	<ul style="list-style-type: none"> – Escluso box doccia e zone a diretto contatto con l'acqua – Si sconsiglia l'utilizzo in bagno e come paraschizzi della cucina
Dettagli	<ul style="list-style-type: none"> – I modelli H4, H6 e H7 sono MINI, ridotti in scala rispetto a quelli standard – Ordine minimo 12 piastrelle – Per rivestire 1 m² sono necessarie 12 piastrelle
Imballaggio	<ul style="list-style-type: none"> – Scatola di cartone TIPO E – Max 12 pezzi per scatola
Installazione	<ul style="list-style-type: none"> – È necessaria una fuga di almeno 2 mm – Può essere installato utilizzando adesivi e stucchi epossidici – Può essere lavorato in cantiere con attrezzi idonei, fare riferimento al Manuale di Installazione per procedure e dettagli

REGULATIONS

	Standard	Requisites	Results
Coeff. di dilatazione termica lineare	ISO 10545-8	from 25°C to 100°C (10-6 °C-1)	17,1 (Copper)
Resistance to chemical products for housekeeping	ISO 10545-13	A - B - C	A
Stain resistance	ISO 10545-14	1 - 5	Test method certificate available on request
Accelerated aging with UV lamp	ASTM G 145-16	Exposure time 500 hours	Gray scale evaluation: 4/5 slight variation in surface gloss and slight variation in color

NORMATIVE

	Standard	Requisites	Results
Coeff. di dilatazione termica lineare	ISO 10545-8	from 25°C to 100°C (10-6 °C-1)	17,1 (Rame)
Resistenza ai prodotti chimici di uso domestico	ISO 10545-13	A - B - C	A
Resistenza alle macchie	ISO 10545-14	1 - 5	Certificato metodo di prova disponibile su richiesta
Invecchiamento accelerato con lampada UV	ASTM G 145-16	Tempo di esposizione 500 ore	Valutazione scala di grigi: 4/5 lieve variazione di lucentezza superficiale e lieve variazione di colore

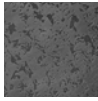
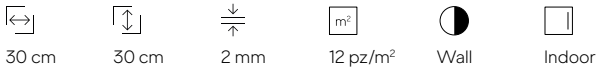

DS107-H8

**STAINLESS STEEL
ACCIAIO INOX**

CODE / CODICE	IN	OUT	METAL FINISHES	MINIMUM ORDER/ORDINE MINIMO	EURO
DS107-H8-IX	•		Stainless steel Acciaio	DeErosion DeErosion H8	12 pezzi/pieces 180,00 Per piece Al pezzo

1,4 kg/pz 16 Kg/m² 1 box = 12 pieces 18,3 kg W. 41 D. 41 H. 9 cm

Excluding VAT
IVA esclusa



DS107-H4 MINI DS107-H6 MINI DCS107-H7 MINI DS107-H8

**BRASS
OTTONE**

CODE / CODICE	IN	OUT	METAL FINISHES	MINIMUM ORDER/ORDINE MINIMO	EURO
DS107-H4-M-OT	•		Brass Ottone	DeErosion DeErosion H4M	12 pezzi/pieces 210,00 Per piece Al pezzo
DS107-H6-M-OT	•		Brass Ottone	DeErosion Mini DeErosion Mini H6M	12 pezzi/pieces 210,00 Per piece Al pezzo
DS107-H7-M-OT	•		Brass Ottone	DeErosion Mini DeErosion Mini H7M	12 pezzi/pieces 210,00 Per piece Al pezzo
DS107-H8-OT	•		Brass Ottone	DeErosion Mini DeErosion Mini H8	12 pezzi/pieces 210,00 Per piece Al pezzo

[On request
Su richiesta](#) Other DeErosion finishes on brass, subject to confirmation of feasibility by De Castelli
Altre finiture DeErosion su ottone, previa conferma fattibilità da parte di De Castelli DS107-H8-OT +15%

1,5 kg/pz 17 Kg/m² 1 box = 12 pieces 19,5 kg W. 41 D. 41 H. 9 cm

Excluding VAT
IVA esclusa



DS107-H4 MINI DS107-H6 MINI DCS107-H7 MINI DS107-H8

**COPPER
RAME**

CODE / CODICE	IN	OUT	METAL FINISHES	MINIMUM ORDER/ORDINE MINIMO	EURO
DS107-H4-M-RA	•		Copper Rame	DeErosion DeErosion H4M	12 pezzi/pieces 250,00 Per piece Al pezzo
DS107-H6-M-RA	•		Copper Rame	DeErosion Mini DeErosion Mini H6M	12 pezzi/pieces 250,00 Per piece Al pezzo
DS107-H7-M-RA	•		Copper Rame	DeErosion Mini DeErosion Mini H7M	12 pezzi/pieces 250,00 Per piece Al pezzo
DS107-H8-RA	•		Copper Rame	DeErosion Mini DeErosion Mini H8	12 pezzi/pieces 250,00 Per piece Al pezzo

[On request
Su richiesta](#) Other DeErosion finishes on copper, subject to confirmation of feasibility by De Castelli
Altre finiture DeErosion su rame, previa conferma fattibilità da parte di De Castelli DS107-H8-RA +15%

1,6 kg/pz 17,8 Kg/m² 1 box = 12 pieces 20,7 kg W. 41 D. 41 H. 9 cm

Excluding VAT
IVA esclusa

Forma

DESIGN BY R&D DE CASTELLI

Tiles available in 7 shapes, from rectangular to square and even hexagonal.

Piastrelle disponibili in 7 forme, dal rettangolare al quadrato e anche esagonale.

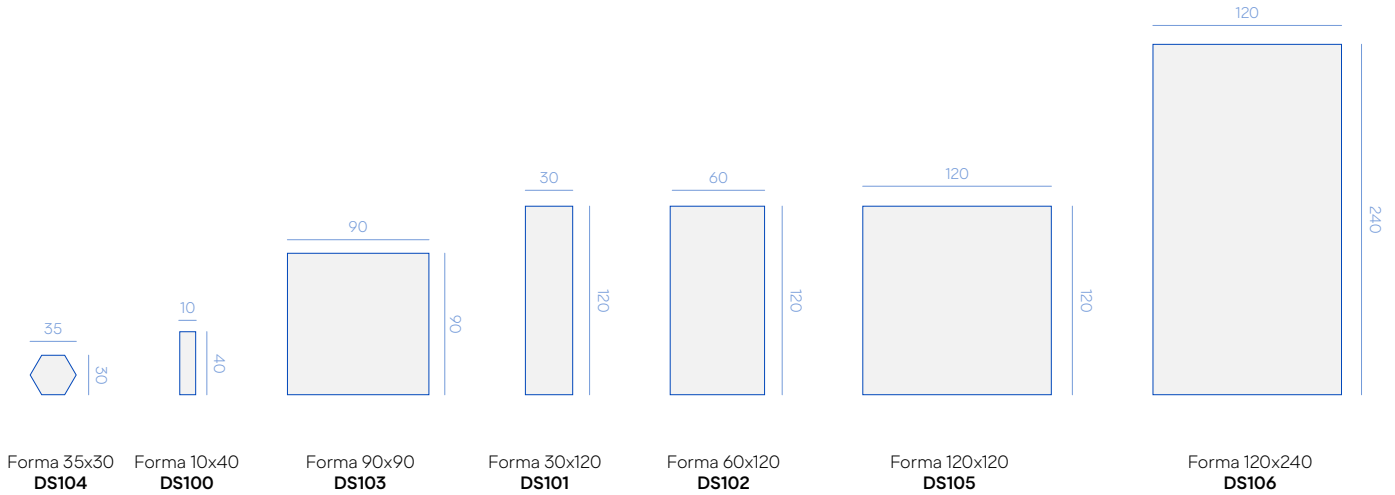

PRODUCT SPECIFICATION

Limits	<ul style="list-style-type: none"> - Shower cabin and areas in direct contact with water excluded - Bathroom and kitchen backsplash are not recommended
Details	- A minimum order is required, depending on the model
Packaging	- Depending on the model, specified and to be quoted at order confirmation
Installation	<ul style="list-style-type: none"> - At least 2 mm grout line is required - It can be installed using epoxy adhesives and grouts - It can be processed on site with suitable tools, refer to Installation Manual for procedures and details

SPECIFICHE PRODOTTO

Limits	<ul style="list-style-type: none"> - Escluso box doccia e zone a diretto contatto con l'acqua - Si sconsiglia l'utilizzo in bagno e come paraschizzi della cucina
Dettagli	- È richiesto un ordine minimo, a seconda del modello
Imballaggio	- A seconda del modello, specificato e da preventivare alla conferma d'ordine
Installazione	<ul style="list-style-type: none"> - È necessaria una fuga di almeno 2 mm - Può essere installato utilizzando adesivi e stucchi epossidici - Può essere lavorato in cantiere con attrezzi idonei, fare riferimento al Manuale di Installazione per procedure e dettagli

REGULATIONS

	Standard	Requisites	Results
Coeff. di dilatazione termica lineare	ISO 10545-8	from 25°C to 100°C (10-6 °C-1)	17,1 (Copper)
Resistance to chemical products for housekeeping	ISO 10545-13	A - B - C	A
Stain resistance	ISO 10545-14	1 - 5	Test method certificate available on request
Accelerated aging with UV lamp	ASTM G 145-16	Exposure time 500 hours	Gray scale evaluation: 4/5 slight variation in surface gloss and slight variation in color

NORMATIVE

	Standard	Requisites	Results
Coeff. di dilatazione termica lineare	ISO 10545-8	from 25°C to 100°C (10-6 °C-1)	17,1 (Rame)
Resistenza ai prodotti chimici di uso domestico	ISO 10545-13	A - B - C	A
Resistenza alle macchie	ISO 10545-14	1 - 5	Certificato metodo di prova disponibile su richiesta
Invecchiamento accelerato con lampada UV	ASTM G 145-16	Tempo di esposizione 500 ore	Valutazione scala di grigi: 4/5 lieve variazione di lucentezza superficiale e lieve variazione di colore

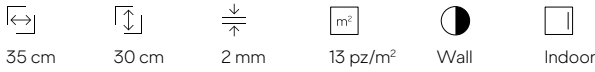

The striations of the finishes E6, G7, G6 follow the long edge of the module
La striatura delle finiture E6, G7, G6 segue il lato lungo del modulo



E6 E5 G2 G12

**STAINLESS STEEL
ACCIAIO INOX**

CODE / CODICE	IN	OUT	METAL FINISHES	MINIMUM ORDER/ORDINE MINIMO	EURO
DS104-E5	•		Stainless steel Acciaio inox DeLabré B DeLabré B	E5 15 pieces/pezzi	90,00 Per piece Al pezzo
DS104-G2	•		Stainless steel Acciaio inox Orbitale Delabré DeLabré orbitale	G2 15 pieces/pezzi	95,00 Per piece Al pezzo
DS104-E6	•		Stainless steel Acciaio inox Striped Delabré DeLabré striato	E6 15 pieces/pezzi	100,00 Per piece Al pezzo
DS104-G12	•		Stainless steel Acciaio inox DeDeep DeDeep	G12 15 pieces/pezzi	110,00 Per piece Al pezzo

[On request](#)
[Su richiesta](#) Other finishes on stainless steel, subject to confirmation of feasibility by De Castelli
Altre finiture su acciaio inox, previa conferma fattibilità da parte di De Castelli DS104-G12 +15%

1,2 kg/pz 16 Kg/m²

Excluding VAT
IVA esclusa

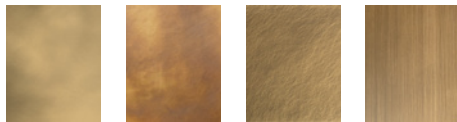

M9 F2 G3 G7

**BRASS
OTTONE**

CODE / CODICE	IN	OUT	METAL FINISHES	MINIMUM ORDER/ORDINE MINIMO	EURO
DS104-M9	•		Brass Ottone Brushed Spazzolato	M9 15 pieces/pezzi	130,00 Per piece Al pezzo
DS104-F2	•		Brass Ottone DeLabré DeLabré	F2 15 pieces/pezzi	160,00 Per piece Al pezzo
DS104-G3	•		Brass Ottone Orbitale Delabré DeLabré orbitale	G3 15 pieces/pezzi	170,00 Per piece Al pezzo
DS104-G7	•		Brass Ottone Striped Delabré DeLabré striato	G7 15 pieces/pezzi	180,00 Per piece Al pezzo

[On request](#)
[Su richiesta](#) Other finishes on brass, subject to confirmation of feasibility by De Castelli
Altre finiture su ottone, previa conferma fattibilità da parte di De Castelli DS104-G7 +15%

1,3kg/pz 17 Kg/m²

Excluding VAT
IVA esclusa

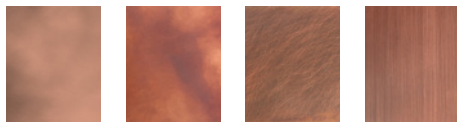

M10 G5 G4 G6

**COPPER
RAME**

CODE / CODICE	IN	OUT	METAL FINISHES	MINIMUM ORDER/ORDINE MINIMO	EURO
DS104-M10	•		Copper Rame Brushed Spazzolato	M10 15 pieces/pezzi	145,00 Per piece Al pezzo
DS104-G5	•		Copper Rame DeLabré DeLabré	G5 15 pieces/pezzi	180,00 Per piece Al pezzo
DS104-G4	•		Copper Rame Orbitale Delabré DeLabré orbitale	G4 15 pieces/pezzi	185,00 Per piece Al pezzo
DS104-G6	•		Copper Rame Striped Delabré DeLabré striato	G6 15 pieces/pezzi	195,00 Per piece Al pezzo

[On request](#)
[Su richiesta](#) Other finishes on copper, subject to confirmation of feasibility by De Castelli
Altre finiture su rame, previa conferma fattibilità da parte di De Castelli DS104-G6 +15%

1,4 kg/pz 17,8 Kg/m²

Excluding VAT
IVA esclusa



The striations of the finishes E6, G7, G6 follow the long edge of the module
La striatura delle finiture E6, G7, G6 segue il lato lungo del modulo



E6 E5 G2 G12

**STAINLESS STEEL
ACCIAIO INOX**

CODE / CODICE	IN	OUT	METAL FINISHES	MINIMUM ORDER/ORDINE MINIMO	EURO
DS100-E5	•		Stainless steel Acciaio inox DeLabré B DeLabré B	E5 25 pieces/pezzi	50,00 Per piece Al pezzo
DS100-G2	•		Stainless steel Acciaio inox Orbitale Delabré DeLabré orbitale	G2 25 pieces/pezzi	55,00 Per piece Al pezzo
DS100-E6	•		Stainless steel Acciaio inox Striped Delabré DeLabré striato	E6 25 pieces/pezzi	60,00 Per piece Al pezzo
DS103-G12	•		Stainless steel Acciaio inox DeDeep DeDeep	G12 25 pieces/pezzi	65,00 Per piece Al pezzo

[On request
Su richiesta](#) Other finishes on stainless steel, subject to confirmation of feasibility by De Castelli
Altre finiture su acciaio inox, previa conferma fattibilità da parte di De Castelli DS100-G12 +15%

0,64 16 Kg/m²

Excluding VAT
IVA esclusa



M9 F2 G3 G7

**BRASS
OTTONE**

CODE / CODICE	IN	OUT	METAL FINISHES	MINIMUM ORDER/ORDINE MINIMO	EURO
DS100-M9	•		Brass Ottone Brushed Spazzolato	M9 25 pieces/pezzi	70,00 Per piece Al pezzo
DS100-F2	•		Brass Ottone DeLabré DeLabré	F2 25 pieces/pezzi	80,00 Per piece Al pezzo
DS100-G3	•		Brass Ottone Orbitale Delabré DeLabré orbitale	G3 25 pieces/pezzi	90,00 Per piece Al pezzo
DS100-G7	•		Brass Ottone Striped Delabré DeLabré striato	G7 25 pieces/pezzi	100,00 Per piece Al pezzo

[On request
Su richiesta](#) Other finishes on brass, subject to confirmation of feasibility by De Castelli
Altre finiture su ottone, previa conferma fattibilità da parte di De Castelli DS100-G7 +15%

0,68 kg/pz 17 Kg/m²

Excluding VAT
IVA esclusa

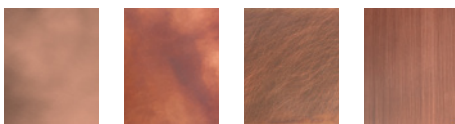

M10 G5 G4 G6

**COPPER
RAME**

CODE / CODICE	IN	OUT	METAL FINISHES	MINIMUM ORDER/ORDINE MINIMO	EURO
DS100-M10	•		Copper Rame Brushed Spazzolato	M10 25 pieces/pezzi	80,00 Per piece Al pezzo
DS100-G5	•		Copper Rame DeLabré DeLabré	G5 25 pieces/pezzi	90,00 Per piece Al pezzo
DS100-G4	•		Copper Rame Orbitale Delabré DeLabré orbitale	G4 25 pieces/pezzi	100,00 Per piece Al pezzo
DS100-G6	•		Copper Rame Striped Delabré DeLabré striato	G6 25 pieces/pezzi	110,00 Per piece Al pezzo

[On request
Su richiesta](#) Other finishes on copper, subject to confirmation of feasibility by De Castelli
Altre finiture su rame, previa conferma fattibilità da parte di De Castelli DS100-G6 +15%

0,71 kg/pz 17,8 Kg/m²

Excluding VAT
IVA esclusa

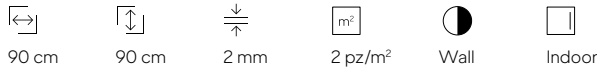

The striations of the finishes E6, G7, G6 follow the long edge of the module
La striatura delle finiture E6, G7, G6 segue il lato lungo del modulo

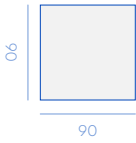

E6 E5 G2 G12

**STAINLESS STEEL
ACCIAIO INOX**

CODE / CODICE	IN	OUT	METAL FINISHES	MINIMUM ORDER/ORDINE MINIMO	EURO
DS103-E5	•		Stainless steel Acciaio inox DeLabré B DeLabré B	E5	1 pieces/pezzi 540,00 Per piece Al pezzo
DS103-G2	•		Stainless steel Acciaio inox Orbitale Delabré DeLabré orbitale	G2	1 pieces/pezzi 600,00 Per piece Al pezzo
DS103-E6	•		Stainless steel Acciaio inox Striped Delabré DeLabré striato	E6	1 pieces/pezzi 650,00 Per piece Al pezzo
DS103-G12	•		Stainless steel Acciaio inox DeDeep DeDeep	G12	1 pieces/pezzi 700,00 Per piece Al pezzo

[On request](#)
[Su richiesta](#) Other finishes on stainless steel, subject to confirmation of feasibility by De Castelli
Altre finiture su acciaio inox, previa conferma fattibilità da parte di De Castelli DS103-G12 +15%

13 kg/pz

16 Kg/m²

Excluding VAT
IVA esclusa

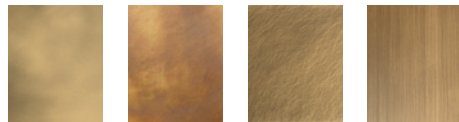

M9 F2 G3 G7

**BRASS
OTTONE**

CODE / CODICE	IN	OUT	METAL FINISHES	MINIMUM ORDER/ORDINE MINIMO	EURO
DS103-M9	•		Brass Ottone Brushed Spazzolato	M9	1 pieces/pezzi 890,00 Per piece Al pezzo
DS103-F2	•		Brass Ottone DeLabré DeLabré	F2	1 pieces/pezzi 1.000,00 Per piece Al pezzo
DS103-G3	•		Brass Ottone Orbitale Delabré DeLabré orbitale	G3	1 pieces/pezzi 1.100,00 Per piece Al pezzo
DS103-G7	•		Brass Ottone Striped Delabré DeLabré striato	G7	1 pieces/pezzi 1.200,00 Per piece Al pezzo

[On request](#)
[Su richiesta](#) Other finishes on brass, subject to confirmation of feasibility by De Castelli
Altre finiture su ottone, previa conferma fattibilità da parte di De Castelli DS103-G7 +15%

13,8 kg/pz

17 Kg/m²

Excluding VAT
IVA esclusa



M10 G5 G4 G6

**COPPER
RAME**

CODE / CODICE	IN	OUT	METAL FINISHES	MINIMUM ORDER/ORDINE MINIMO	EURO
DS103-M10	•		Copper Rame Brushed Spazzolato	M10	1 pieces/pezzi 1.150,00 Per piece Al pezzo
DS103-G5	•		Copper Rame DeLabré DeLabré	G5	1 pieces/pezzi 1.200,00 Per piece Al pezzo
DS103-G4	•		Copper Rame Orbitale Delabré DeLabré orbitale	G4	1 pieces/pezzi 1.300,00 Per piece Al pezzo
DS103-G6	•		Copper Rame Striped Delabré DeLabré striato	G6	1 pieces/pezzi 1.400,00 Per piece Al pezzo

[On request](#)
[Su richiesta](#) Other finishes on copper, subject to confirmation of feasibility by De Castelli
Altre finiture su rame, previa conferma fattibilità da parte di De Castelli DS103-G6 +15%

14,4 kg/pz

17,8 Kg/m²

Excluding VAT
IVA esclusa



The striations of the finishes E6, G7, G6 follow the long edge of the module
La striatura delle finiture E6, G7, G6 segue il lato lungo del modulo

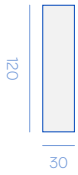

E6 E5 G2 G12

**STAINLESS STEEL
ACCIAIO INOX**

CODE / CODICE	IN	OUT	METAL FINISHES	MINIMUM ORDER/ORDINE MINIMO	EURO
DS101-E5	•		Stainless steel Acciaio inox DeLabré B DeLabré B	E5 3 pieces/pezzi	290,00 Per piece Al pezzo
DS101-G2	•		Stainless steel Acciaio inox Orbitale Delabré DeLabré orbitale	G2 3 pieces/pezzi	330,00 Per piece Al pezzo
DS101-E6	•		Stainless steel Acciaio inox Striped Delabré DeLabré striato	E6 3 pieces/pezzi	350,00 Per piece Al pezzo
DS101-G12	•		Stainless steel Acciaio inox DeDeep DeDeep	G12 3 pieces/pezzi	370,00 Per piece Al pezzo

[On request](#)
[Su richiesta](#) Other finishes on stainless steel, subject to confirmation of feasibility by De Castelli
Altre finiture su acciaio inox, previa conferma fattibilità da parte di De Castelli DS101-G12 +15%

5.7 kg/pz 16 Kg/m²

Excluding VAT
IVA esclusa



M9 F2 G3 G7

**BRASS
OTTONE**

CODE / CODICE	IN	OUT	METAL FINISHES	MINIMUM ORDER/ORDINE MINIMO	EURO
DS101-M9	•		Brass Ottone Brushed Spazzolato	M9 3 pieces/pezzi	400,00 Per piece Al pezzo
DS101-F2	•		Brass Ottone DeLabré DeLabré	F2 3 pieces/pezzi	470,00 Per piece Al pezzo
DS101-G3	•		Brass Ottone Orbitale Delabré DeLabré orbitale	G3 3 pieces/pezzi	510,00 Per piece Al pezzo
DS101-G7	•		Brass Ottone Striped Delabré DeLabré striato	G7 3 pieces/pezzi	560,00 Per piece Al pezzo

[On request](#)
[Su richiesta](#) Other finishes on brass, subject to confirmation of feasibility by De Castelli
Altre finiture su ottone, previa conferma fattibilità da parte di De Castelli DS101-G7 +15%

6 kg/pz 17 Kg/m²

Excluding VAT
IVA esclusa

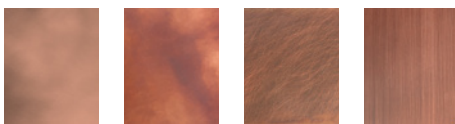

M10 G5 G4 G6

**COPPER
RAME**

CODE / CODICE	IN	OUT	METAL FINISHES	MINIMUM ORDER/ORDINE MINIMO	EURO
DS101-M10	•		Copper Rame Brushed Spazzolato	M10 3 pieces/pezzi	480,00 Per piece Al pezzo
DS101-G5	•		Copper Rame DeLabré DeLabré	G5 3 pieces/pezzi	550,00 Per piece Al pezzo
DS101-G4	•		Copper Rame Orbitale Delabré DeLabré orbitale	G4 3 pieces/pezzi	590,00 Per piece Al pezzo
DS101-G6	•		Copper Rame Striped Delabré DeLabré striato	G6 3 pieces/pezzi	630,00 Per piece Al pezzo

[On request](#)
[Su richiesta](#) Other finishes on copper, subject to confirmation of feasibility by De Castelli
Altre finiture su rame, previa conferma fattibilità da parte di De Castelli DS101-G6 +15%

6,4 kg/pz 17,8 Kg/m²

Excluding VAT
IVA esclusa

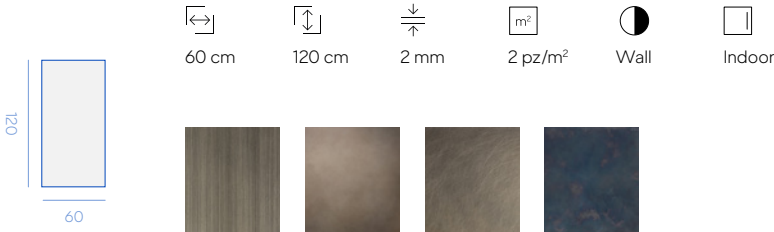

The striations of the finishes E6, G7, G6 follow the long edge of the module
La striatura delle finiture E6, G7, G6 segue il lato lungo del modulo



E6 E5 G2 G12

**STAINLESS STEEL
ACCIAIO INOX**

CODE / CODICE	IN	OUT	METAL FINISHES	MINIMUM ORDER/ORDINE MINIMO	EURO
DS102-E5	•		Stainless steel Acciaio inox DeLabré B DeLabré B	E5 2 pieces/pezzi	590,00 Per piece Al pezzo
DS102-G2	•		Stainless steel Acciaio inox Orbitale Delabré DeLabré orbitale	G2 2 pieces/pezzi	660,00 Per piece Al pezzo
DS102-E6	•		Stainless steel Acciaio inox Striped Delabré DeLabré striato	E6 2 pieces/pezzi	710,00 Per piece Al pezzo
DS102-G12	•		Stainless steel Acciaio inox DeDeep DeDeep	G12 2 pieces/pezzi	770,00 Per piece Al pezzo

[On request
Su richiesta](#) Other finishes on stainless steel, subject to confirmation of feasibility by De Castelli
Altre finiture su acciaio inox, previa conferma fattibilità da parte di De Castelli DS102-G12 +15%

11,5 kg/pz 16 Kg/m²

Excluding VAT
IVA esclusa



M9 F2 G3 G7

**BRASS
OTTONE**

CODE / CODICE	IN	OUT	METAL FINISHES	MINIMUM ORDER/ORDINE MINIMO	EURO
DS102-M9	•		Brass Ottone Brushed Spazzolato	M9 2 pieces/pezzi	950,00 Per piece Al pezzo
DS102-F2	•		Brass Ottone DeLabré DeLabré	F2 2 pieces/pezzi	1.050,00 Per piece Al pezzo
DS102-G3	•		Brass Ottone Orbitale Delabré DeLabré orbitale	G3 2 pieces/pezzi	1.150,00 Per piece Al pezzo
DS102-G7	•		Brass Ottone Striped Delabré DeLabré striato	G7 2 pieces/pezzi	1.250,00 Per piece Al pezzo

[On request
Su richiesta](#) Other finishes on brass, subject to confirmation of feasibility by De Castelli
Altre finiture su ottone, previa conferma fattibilità da parte di De Castelli DS102-G7 +15%

12,2 kg/pz 17 Kg/m²

Excluding VAT
IVA esclusa

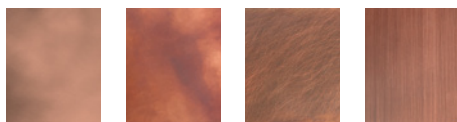

M10 G5 G4 G6

**COPPER
RAME**

CODE / CODICE	IN	OUT	METAL FINISHES	MINIMUM ORDER/ORDINE MINIMO	EURO
DS102-M10	•		Copper Rame Brushed Spazzolato	M10 2 pieces/pezzi	1.200,00 Per piece Al pezzo
DS102-G5	•		Copper Rame DeLabré DeLabré	G5 2 pieces/pezzi	1.270,00 Per piece Al pezzo
DS102-G4	•		Copper Rame Orbitale Delabré DeLabré orbitale	G4 2 pieces/pezzi	1.370,00 Per piece Al pezzo
DS102-G6	•		Copper Rame Striped Delabré DeLabré striato	G6 2 pieces/pezzi	1.470,00 Per piece Al pezzo

[On request
Su richiesta](#) Other finishes on copper, subject to confirmation of feasibility by De Castelli
Altre finiture su rame, previa conferma fattibilità da parte di De Castelli DS102-G6 +15%

12,8 kg/pz 17,8 Kg/m²

Excluding VAT
IVA esclusa

FORMA 120X120



The striations of the finishes E6, G7, G6 follow the long edge of the module
La striatura delle finiture E6, G7, G6 segue il lato lungo del modulo

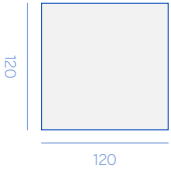

E6 E5 G2 G12

**STAINLESS STEEL
ACCIAIO INOX**

CODE / CODICE	IN	OUT	METAL FINISHES	MINIMUM ORDER/ORDINE MINIMO	EURO
DS105-E5	•		Stainless steel Acciaio inox DeLabré B DeLabré B	E5 1 pieces/pezzi	1.180,00 Per piece Al pezzo
DS105-G2	•		Stainless steel Acciaio inox Orbitale Delabré DeLabré orbitale	G2 1 pieces/pezzi	1.270,00 Per piece Al pezzo
DS105-E6	•		Stainless steel Acciaio inox Striped Delabré DeLabré striato	E6 1 pieces/pezzi	1.330,00 Per piece Al pezzo
DS105-G12	•		Stainless steel Acciaio inox DeDeep DeDeep	G12 1 pieces/pezzi	1.400,00 Per piece Al pezzo

[On request](#)
[Su richiesta](#) Other finishes on stainless steel, subject to confirmation of feasibility by De Castelli
Altre finiture su acciaio inox, previa conferma fattibilità da parte di De Castelli DS105-G12 +15%

23 kg/pz 16 Kg/m²

Excluding VAT
IVA esclusa



M9 F2 G3 G7

**BRASS
OTTONE**

CODE / CODICE	IN	OUT	METAL FINISHES	MINIMUM ORDER/ORDINE MINIMO	EURO
DS105-M9	•		Brass Ottone Brushed Spazzolato	M9 1 pieces/pezzi	1.500,00 Per piece Al pezzo
DS105-F2	•		Brass Ottone DeLabré DeLabré	F2 1 pieces/pezzi	1.7000,00 Per piece Al pezzo
DS105-G3	•		Brass Ottone Orbitale Delabré DeLabré orbitale	G3 1 pieces/pezzi	1.800,00 Per piece Al pezzo
DS105-G7	•		Brass Ottone Striped Delabré DeLabré striato	G7 1 pieces/pezzi	1.900,00 Per piece Al pezzo

[On request](#)
[Su richiesta](#) Other finishes on copper, subject to confirmation of feasibility by De Castelli
Altre finiture su rame, previa conferma fattibilità da parte di De Castelli DS105-G7 +15%

24,5 kg/pz 17 Kg/m²

Excluding VAT
IVA esclusa

FORMA 120X240

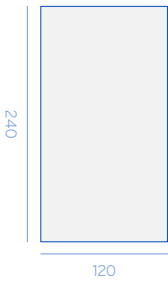

- 120 cm
- 240 cm
- 2 mm
- 1 pz/m²
- Wall
- Indoor

The striations of the finishes E6, G7, G6 follow the long edge of the module
La striatura delle finiture E6, G7, G6 segue il lato lungo del modulo



E6 E5 G2 G12

**STAINLESS STEEL
ACCIAIO INOX**

CODE / CODICE	IN	OUT	METAL FINISHES	MINIMUM ORDER/ORDINE MINIMO	EURO
DS106-E5	•		Stainless steel Acciaio inox DeLabré B DeLabré B	E5 1 pieces/pezzi	2.360,00 Per piece Al pezzo
DS106-G2	•		Stainless steel Acciaio inox Orbitale Delabré DeLabré orbitale	G2 1 pieces/pezzi	2.560,00 Per piece Al pezzo
DS106-E6	•		Stainless steel Acciaio inox Striped Delabré DeLabré striato	E6 1 pieces/pezzi	2.660,00 Per piece Al pezzo
DS106-G12	•		Stainless steel Acciaio inox DeDeep DeDeep	G12 1 pieces/pezzi	2.760,00 Per piece Al pezzo

[On request](#)
[Su richiesta](#) Other finishes on stainless steel, subject to confirmation of feasibility by De Castelli
Altre finiture su acciaio inox, previa conferma fattibilità da parte di De Castelli DS106-G12 +15%

46 kg/pz 16 Kg/m²

Excluding VAT
IVA esclusa



M9 F2 G3 G7

**BRASS
OTTONE**

CODE / CODICE	IN	OUT	METAL FINISHES	MINIMUM ORDER/ORDINE MINIMO	EURO
DS106-M9	•		Brass Ottone Brushed Spazzolato	M9 1 pieces/pezzi	3.000,00 Per piece Al pezzo
DS106-F2	•		Brass Ottone DeLabré DeLabré	F2 1 pieces/pezzi	3.200,00 Per piece Al pezzo
DS106-G3	•		Brass Ottone Orbitale Delabré DeLabré orbitale	G3 1 pieces/pezzi	3.600,00 Per piece Al pezzo
DS106-G7	•		Brass Ottone Striped Delabré DeLabré striato	G7 1 pieces/pezzi	3.800,00 Per piece Al pezzo

[On request](#)
[Su richiesta](#) Other finishes on copper, subject to confirmation of feasibility by De Castelli
Altre finiture su rame, previa conferma fattibilità da parte di De Castelli DS106-G7 +15%

49 kg/pz 17 Kg/m²

Excluding VAT
IVA esclusa

DESIGN BY LEONARDO SONNOLI

Tiles available in 4 models which can be combined to provide maximum freedom of composition.

Piastrelle disponibili in 4 modelli abbinabili per garantire la massima libertà compositiva.

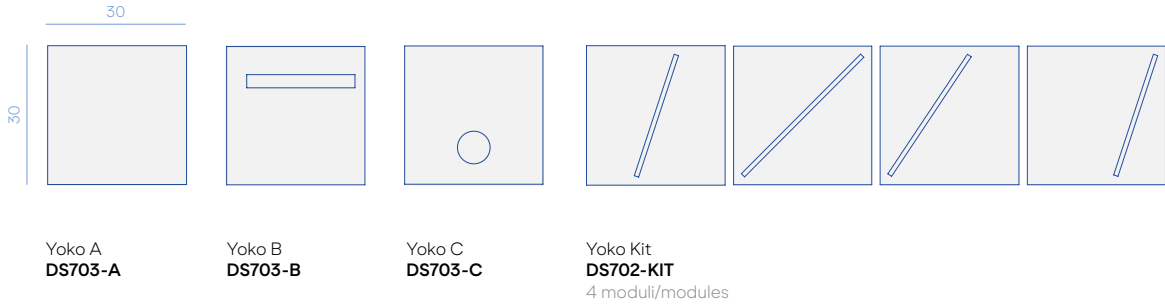

PRODUCT SPECIFICATION

Limits	<ul style="list-style-type: none"> – Shower cabin and areas in direct contact with water excluded – Bathroom and kitchen backsplash are not recommended
Details	<ul style="list-style-type: none"> – Minimum order 12 tiles – 12 tiles are required to clad 1 m²
DS702-KIT	<ul style="list-style-type: none"> – Elements not sold individually, only in KIT – Minimum order 20 KIT – 24 KIT are required to clad 1 m²
Packaging	<ul style="list-style-type: none"> – Carton box TYPE E – Max 12 pieces each box
Installation	<ul style="list-style-type: none"> – At least 2 mm grout line is required – It can be installed using epoxy adhesives and grouts – It can be processed on site with suitable tools, refer to Installation Manual for procedures and details

REGULATIONS

	Standard	Requisites	Results
Resistance to chemical products for housekeeping	ISO 10545-13	A - B - C	A
Stain resistance	ISO 10545-14	1 - 5	Test method certificate available on request
Accelerated aging with UV lamp	ASTM G 145-16	Exposure time 500 hours	Gray scale evaluation: 4/5 slight variation in surface gloss and slight variation in color







SPECIFICHE PRODOTTO

Limits	<ul style="list-style-type: none"> – Escluso box doccia e zone a diretto contatto con l'acqua – Si sconsiglia l'utilizzo in bagno e come paraschizzi della cucina
Dettagli	<ul style="list-style-type: none"> – Ordine minimo 12 piastrelle – Per rivestire 1 m² sono necessarie 12 piastrelle
DS702-KIT	<ul style="list-style-type: none"> – Elementi non vendibili singolarmente, solo in KIT – Ordine minimo 20 KIT – Per rivestire 1 m² sono necessari 24 KIT
Imballaggio	<ul style="list-style-type: none"> – Scatola di cartone TIPO E – Max 12 pezzi per scatola
Installazione	<ul style="list-style-type: none"> – È necessaria una fuga di almeno 2 mm – Può essere installato utilizzando adesivi e stucchi epossidici – Può essere lavorato in cantiere con attrezzi idonei, fare riferimento al Manuale di Installazione per procedure e dettagli

NORMATIVE

	Standard	Requisites	Results
Resistenza ai prodotti chimici di uso domestico	ISO 10545-13	A - B - C	A
Resistenza alle macchie	ISO 10545-14	1 - 5	Certificato metodo di prova disponibile su richiesta
Invecchiamento accelerato con lampada UV	ASTM G 145-16	Tempo di esposizione 500 ore	Valutazione scala di grigi: 4/5 lieve variazione di lucentezza superficiale e lieve variazione di colore

YOKO A

 30 cm
  30 cm
  4 mm
  12 pz/m²
  Wall
  Indoor

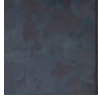







A

CODE / CODICE	IN	OUT	METAL FINISHES	MINIMUM ORDER/ORDINE MINIMO	EURO		
DS703-A	•		Stainless steel Acciaio inox	DeDeep DeDeep	G12	12 pieces/ pezzi	120,00 Per piece Al pezzo

 2,1 kg/pz
  25,2 Kg/m²
 1 box = 6 pieces
  14,1 kg
  W. 41 D. 41 H. 9 cm

Excluding VAT
IVA esclusa

YOKO B

 30 cm
  30 cm
  4 mm
  12 pz/m²
  Wall
  Indoor



B-OT B-RA

CODE / CODICE	IN	OUT	METAL FINISHES	MINIMUM ORDER/ORDINE MINIMO	EURO		
DS703-B-OT	•		Stainless steel Acciaio inox	DeDeep DeDeep	G12	12 pieces/ pezzi	195,00 Per piece Al pezzo
			Brass Ottone	Brushed Spazzolato	M9		
DS703-B-RA	•		Stainless steel Acciaio inox	DeDeep DeDeep	G12	12 pieces/ pezzi	195,00 Per piece Al pezzo
			Copper Rame	Brushed Spazzolato	M10		

 2,1 kg/pz
  25,2 Kg/m²
 1 box = 6 pieces
  14,1 kg
  W. 41 D. 41 H. 9 cm

Excluding VAT
IVA esclusa

YOKO C

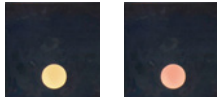
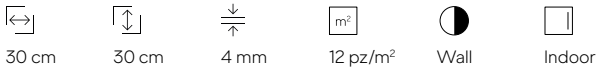

C-OT C-RA

CODE / CODICE	IN	OUT	METAL FINISHES			MINIMUM ORDER/ORDINE MINIMO	EURO
DS703-C-OT	•		Stainless steel Acciaio inox	DeDeep DeDeep	G12	12 pieces/ pezzi	180,00 Per piece Al pezzo
			Brass Ottone	Brushed Spazzolato	M9		
DS703-C-RA	•		Stainless steel Acciaio inox	DeDeep DeDeep	G2	12 pieces/ pezzi	180,00 Per piece Al pezzo
			Copper Rame	Brushed Spazzolato	M10		

2,1 kg/pz
 25,2 Kg/m²
 1 box = 6 pieces
 14,1 kg
 W. 41 D. 41 H. 8,5 cm

Excluding VAT
IVA esclusa

YOKO KIT

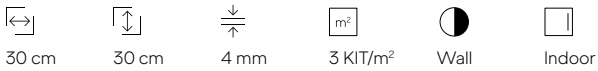

Each KIT consists of 4 different modules that can not be sold separately
Ogni KIT è composto da 4 moduli differenti non vendibili separatamente

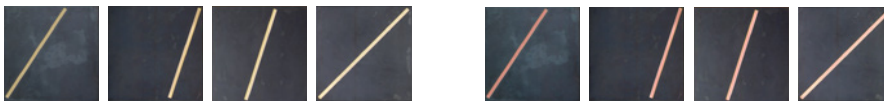

KIT-OT

KIT-RA

CODE / CODICE	IN	OUT	METAL FINISHES			MINIMUM ORDER/ORDINE MINIMO	EURO
DS702-KIT-OT	•		Stainless steel Acciaio inox	DeDeep DeDeep	G12	3 KIT (12 pezzi/pieces)	690,00 Per KIT Al KIT
			Brass Ottone	Brushed Spazzolato	M9		
DS702-KIT-RA	•		Stainless steel Acciaio inox	DeDeep DeDeep	G2	3 KIT (12 pezzi/pieces)	690,00 Per KIT Al KIT
			Copper Rame	Brushed Spazzolato	M10		

2,1 kg/pz
 25,2 Kg/m²
 1 box = 6 pieces
 14,1 kg
 W. 41 D. 41 H. 8,5 cm

Excluding VAT
IVA esclusa

Mosaics
Mosaici

Copycat

DESIGN BY CINO ZUCCHI

Hexagonal mosaic of variable thickness pre-assembled on fiberglass mesh to form a tile with butt-jointed installation.

Mosaico esagonale di spessore variabile preassemblato su rete in fibra di vetro a formare una mattonella con installazione a giunto unito.

Copycat
DS706

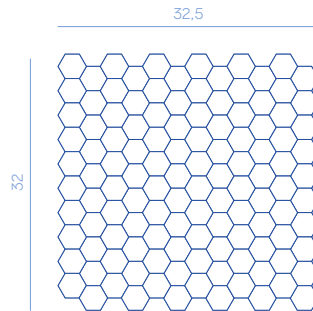

PRODUCT SPECIFICATION

Limits	<ul style="list-style-type: none"> – Shower cabin and areas in direct contact with water excluded – Bathroom and kitchen are not recommended
Details	<ul style="list-style-type: none"> – Hexagonal pieces featuring varying thickness – Minimum order 12 tiles – 12 tiles are required to clad 1 m²
Packaging	<ul style="list-style-type: none"> – Carton box TYPE E – Max 12 pieces each box
Installation	<ul style="list-style-type: none"> – Butt-jointed mosaics tile pre-assembled on a fiberglass mesh – It can be installed using epoxy adhesives and grouts – It can be processed on site with suitable tools, refer to Installation Manual for procedures and details

SPECIFICHE PRODOTTO

Limits	<ul style="list-style-type: none"> – Escluso box doccia e zone a diretto contatto con l'acqua – Si sconsiglia l'utilizzo in bagno e come paraschizzi della cucina
Dettagli	<ul style="list-style-type: none"> – Tessere esagonali di vario spessore – Ordine minimo 12 piastrelle – Per rivestire 1 m² sono necessarie 12 piastrelle
Imballaggio	<ul style="list-style-type: none"> – Scatola di cartone TIPO E – Max 12 pezzi per scatola
Installazione	<ul style="list-style-type: none"> – Piastrella di mosaico a giunto unito preassemblata su rete in fibra di vetro – Può essere installato utilizzando adesivi e stucchi epossidici – Può essere lavorato in cantiere con attrezzi idonei, fare riferimento al Manuale di Installazione per procedure e dettagli

REGULATIONS

	Standard	Requisites	Results
Coeff. di dilatazione termica lineare	ISO 10545-8	from 25°C to 100°C (10-6 °C-1)	17,1 (Copper)
Resistance to chemical products for housekeeping	ISO 10545-13	A - B - C	A
Stain resistance	ISO 10545-14	1 - 5	Test method certificate available on request
Accelerated aging with UV lamp	ASTM G 145-16	Exposure time 500 hours	Gray scale evaluation: 4/5 slight variation in surface gloss and slight variation in color

NORMATIVE

	Standard	Requisites	Results
Coeff. di dilatazione termica lineare	ISO 10545-8	from 25°C to 100°C (10-6 °C-1)	17,1 (Rame)
Resistenza ai prodotti chimici di uso domestico	ISO 10545-13	A - B - C	A
Resistenza alle macchie	ISO 10545-14	1 - 5	Certificato metodo di prova disponibile su richiesta
Invecchiamento accelerato con lampada UV	ASTM G 145-16	Tempo di esposizione 500 ore	Valutazione scala di grigi: 4/5 lieve variazione di lucentezza superficiale e lieve variazione di colore

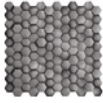

C3

**STAINLESS STEEL
ACCIAIO INOX**

CODE / CODICE	IN	OUT	METAL FINISHES	MINIMUM ORDER/ORDINE MINIMO	EURO
DS706-C3	•		Stainless steel Acciaio inox	C3 12 pezzi/pieces	150,00 Per piece Al pezzo

0,95 kg/pz 12 Kg/m² 1 box = 12 pieces 12,9 kg W. 41 D. 41 H. 9 cm

Excluding VAT
IVA esclusa

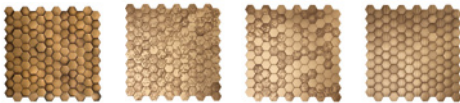

C1 C23 C24 C25

**BRASS
OTTONE**

CODE / CODICE	IN	OUT	METAL FINISHES	MINIMUM ORDER/ORDINE MINIMO	EURO
DS706-C1	•		Brass Ottone	C1 12 pezzi/pieces	200,00 Per piece Al pezzo
DS706-C23	•		Brass fully eroded with a casual pattern Ottone tutto eroso con un pattern casuale	C23 12 pezzi/pieces	240,00 Per piece Al pezzo
DS706-C24	•		Brass partially eroded with a casual pattern Ottone in parte eroso con un pattern casuale	C24 12 pezzi/pieces	240,00 Per piece Al pezzo
DS706-C25	•		Brass fully eroded with a striped pattern Ottone tutto eroso con un pattern rigato	C25 12 pezzi/pieces	260,00 Per piece Al pezzo

1,05 kg/pz 13 Kg/m² 1 box = 12 pieces 14,1 kg W. 41 D. 41 H. 9 cm

Excluding VAT
IVA esclusa

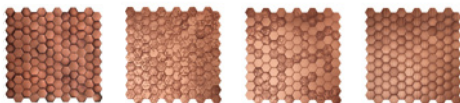

C2 C26 C27 C28







**COPPER
RAME**

CODE / CODICE	IN	OUT	METAL FINISHES	MINIMUM ORDER/ORDINE MINIMO	EURO
DS706-C2	•		Copper Rame	C2 12 pezzi/pieces	250,00 Per piece Al pezzo
DS706-C26	•		Copper fully eroded with a casual pattern Rame tutto eroso con un pattern casuale	C26 12 pezzi/pieces	300,00 Per piece Al pezzo
DS706-C27	•		Copper partially eroded with a casual pattern Rame in parte eroso con un pattern casuale	C27 12 pezzi/pieces	300,00 Per piece Al pezzo
DS706-C28	•		Copper fully eroded with a striped pattern Rame tutto eroso con un pattern rigato	C28 12 pezzi/pieces	320,00 Per piece Al pezzo

1,1 kg/pz 13,5 Kg/m² 1 box = 12 pieces 14,7 kg W. 41 D. 41 H. 9 cm

Excluding VAT
IVA esclusa

COPYCAT MIX

 32,5 cm
  32 cm
  2 mm
  12 pz/m²
  
  Indoor

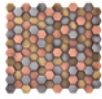

C16

METAL MIX

CODE / CODICE	IN	OUT	METAL FINISHES		MINIMUM ORDER/ORDINE MINIMO	EURO
DS706-16	•		MIX stainless steel, brass and copper MIX acciaio inox, ottone e rame	C16	12 pezzi/pieces	200,00 Per piece Al pezzo

 1,1 kg/pz

 13,5 Kg/m²

1 box = 12 pieces

 14,7 kg

 W. 41 D. 41 H. 9 cm

Excluding VAT
IVA esclusa

Diamond 30

DESIGN BY R&D DE CASTELLI

Square punched mosaic pre-assembled on fiberglass mesh to form a tile with butt-jointed installation.
Mosaico quadrato punzonato preassemblato su rete in fibra di vetro a formare una piastrella con posa a giunto unito.

Diamond 30
DS708

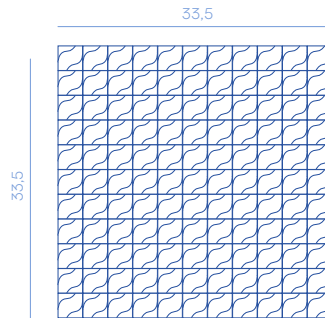

PRODUCT SPECIFICATION

Limits	<ul style="list-style-type: none"> – Shower cabin and areas in direct contact with water excluded – Bathroom and kitchen backsplash are not recommended
Details	<ul style="list-style-type: none"> – 30x30 mm square pieces punched on sides featuring the same thickness – Minimum order 9 tiles – 9 tiles are required to clad 1 m²
Packaging	<ul style="list-style-type: none"> – Carton box TYPE E – Max 10 pieces each box
Installation	<ul style="list-style-type: none"> – Butt-jointed mosaic pre-assembled on a fiberglass mesh – It can be installed using epoxy adhesives – It can be processed on site with suitable tools, refer to Installation Manual for procedures and details

SPECIFICHE PRODOTTO

Limits	<ul style="list-style-type: none"> – Escluso box doccia e zone a diretto contatto con l'acqua – Si sconsiglia l'utilizzo in bagno e come paraschizzi della cucina
Dettagli	<ul style="list-style-type: none"> – Tessere quadrate 30x30 mm dello stesso spessore punzonate sui lati – Ordine minimo 9 piastrelle – Per rivestire 1 m² sono necessarie 9 piastrelle
Imballaggio	<ul style="list-style-type: none"> – Scatola di cartone TIPO E – Max 10 pezzi per scatola
Installazione	<ul style="list-style-type: none"> – Piastrella di mosaico a giunto unito preassemblata su rete in fibra di vetro – Può essere installato utilizzando adesivi e stucchi epossidici – Può essere lavorato in cantiere con attrezzi idonei, fare riferimento al Manuale di Installazione per procedure e dettagli

REGULATIONS

	Standard	Requisites	Results
Coeff. di dilatazione termica lineare	ISO 10545-8	from 25°C to 100°C (10-6 °C-1)	17,1 (Copper)
Resistance to chemical products for housekeeping	ISO 10545-13	A - B - C	A
Stain resistance	ISO 10545-14	1 - 5	Test method certificate available on request
Accelerated aging with UV lamp	ASTM G 145-16	Exposure time 500 hours	Gray scale evaluation: 4/5 slight variation in surface gloss and slight variation in color

NORMATIVE

	Standard	Requisites	Results
Coeff. di dilatazione termica lineare	ISO 10545-8	from 25°C to 100°C (10-6 °C-1)	17,1 (Rame)
Resistenza ai prodotti chimici di uso domestico	ISO 10545-13	A - B - C	A
Resistenza alle macchie	ISO 10545-14	1 - 5	Certificato metodo di prova disponibile su richiesta
Invecchiamento accelerato con lampada UV	ASTM G 145-16	Tempo di esposizione 500 ore	Valutazione scala di grigi: 4/5 lieve variazione di lucentezza superficiale e lieve variazione di colore

DIAMOND 30

33,5 cm
 33,5 cm
 4 mm
 12 pz/m²
 Wall, Floor
 Indoor

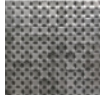

C12

STAINLESS STEEL
ACCIAIO INOX

CODE / CODICE	IN	OUT	METAL FINISHES	MINIMUM ORDER/ORDINE MINIMO	EURO
DS708-C12	•		Stainless steel Acciaio inox	C12 9 pezzi/pieces	170,00 Per piece Al pezzo

1,35 kg/pz
 12 Kg/m²
 1 box = 10 pieces
 15 kg
 W. 41 D. 41 H. 9 cm

Excluding VAT
IVA esclusa



C9

BRASS
OTTONE

CODE / CODICE	IN	OUT	METAL FINISHES	MINIMUM ORDER/ORDINE MINIMO	EURO
DS708-C9	•		Brass Ottone	C9 9 pezzi/pieces	215,00 Per piece Al pezzo

1,45 kg/pz
 12,8 Kg/m²
 1 box = 10 pieces
 16 kg
 W. 41 D. 41 H. 9 cm

Excluding VAT
IVA esclusa



C7

COPPER
RAME

CODE / CODICE	IN	OUT	METAL FINISHES	MINIMUM ORDER/ORDINE MINIMO	EURO
DS708-C7	•		Copper Rame	C7 9 pezzi/pieces	265,00 Per piece Al pezzo

1,5 kg/pz
 13,5 Kg/m²
 1 box = 10 pieces
 16,5 kg
 W. 41 D. 41 H. 9 cm

Excluding VAT
IVA esclusa

Losanga

DESIGN BY NIKITA BETTONI

Rhomboid mosaic of variable thickness pre-assembled on fiberglass mesh to form a tile with butt-jointed installation, available in 2 variants.

Mosaico romboidale a spessore variabile preassemblato su rete in fibra di vetro a formare una piastrella con installazione a giunto unito, disponibile in 2 varianti.

Losanga A
DCS712

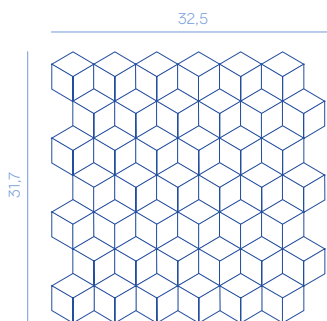

Losanga B
DCS713

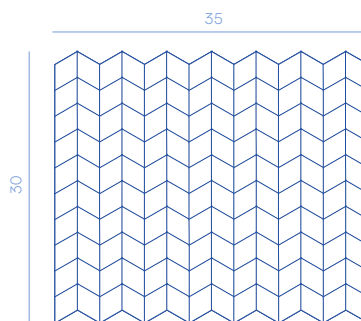

PRODUCT SPECIFICATION

Limits	<ul style="list-style-type: none"> - Shower cabin and areas in direct contact with water excluded - Bathroom and kitchen are not recommend
Details DS712	<ul style="list-style-type: none"> - Rhomboid pieces featuring different edge treatments - Minimum order 12 tiles
DS713	<ul style="list-style-type: none"> - 12 tiles are required to clad 1 m² - Minimum order 10 tiles - 10 tiles are required to clad 1 m²
Packaging DS712 DS713	<ul style="list-style-type: none"> - Carton box TYPE E - Max 12 pieces each box - Max 10 pieces each box
Installation	<ul style="list-style-type: none"> - Butt-jointed mosaic pre-assembled on a fiberglass mesh - It can be installed using epoxy adhesives - It can be processed on site with suitable tools, refer to Installation Manual for procedures and details

SPECIFICHE PRODOTTO

Limits	<ul style="list-style-type: none"> - Escluso box doccia e zone a diretto contatto con l'acqua - Si sconsiglia l'utilizzo in bagno e come paraschizzi della cucina
Dettagli DS712	<ul style="list-style-type: none"> - Pezzi romboidali caratterizzati da diversi trattamenti dei bordi - Ordine minimo 12 piastrelle
DS713	<ul style="list-style-type: none"> - Per rivestire 1 m² sono necessarie 12 piastrelle - Ordine minimo 10 piastrelle - Per rivestire 1 m² sono necessarie 10 piastrelle
Imballaggio DS712 DS713	<ul style="list-style-type: none"> - Scatola di cartone TIPO E - Max 12 pezzi per scatola - Max 10 pezzi per scatola
Installazione	<ul style="list-style-type: none"> - Piastrella di mosaico a giunto unito preassemblata su rete in fibra di vetro - Può essere installato utilizzando adesivi e stucchi epossidici - Può essere lavorato in cantiere con attrezzi idonei, fare riferimento al Manuale di Installazione per procedure e dettagli



REGULATIONS

	Standard	Requisites	Results
Coeff. di dilatazione termica lineare	ISO 10545-8	from 25°C to 100°C (10-6 °C-1)	17,1 (Copper)
Resistance to chemical products for housekeeping	ISO 10545-13	A - B - C	A
Stain resistance	ISO 10545-14	1 - 5	Test method certificate available on request
Accelerated aging with UV lamp	ASTM G 145-16	Exposure time 500 hours	Gray scale evaluation: 4/5 slight variation in surface gloss and slight variation in color

NORMATIVE

	Standard	Requisites	Results
Coeff. di dilatazione termica lineare	ISO 10545-8	from 25°C to 100°C (10-6 °C-1)	17,1 (Rame)
Resistenza ai prodotti chimici di uso domestico	ISO 10545-13	A - B - C	A
Resistenza alle macchie	ISO 10545-14	1 - 5	Certificato metodo di prova disponibile su richiesta
Invecchiamento accelerato con lampada UV	ASTM G 145-16	Tempo di esposizione 500 ore	Valutazione scala di grigi: 4/5 lieve variazione di lucentezza superficiale e lieve variazione di colore

LOSANGA A

 32,5 cm
  31,7 cm
  2 mm
  12 pz/m²
   Wall, Floor
  Indoor

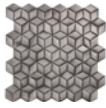

C19

**STAINLESS STEEL
ACCIAIO INOX**

CODE / CODICE	IN	OUT	METAL FINISHES	MINIMUM ORDER/ORDINE MINIMO	EURO
DS712-C19	•		Stainless steel Acciaio inox	C19 12 pieces/pezzi	185,00 Per piece Al pezzo

 1 kg/pz
  12 Kg/m²
 1 box = 12 pieces
  13,5 kg
  W. 41 D. 41 H. 9 cm

Excluding VAT
IVA esclusa



C17

**BRASS
OTTONE**

CODE / CODICE	IN	OUT	METAL FINISHES	MINIMUM ORDER/ORDINE MINIMO	EURO
DS712-C17	•		Brass Ottone	C17 12 pieces/pezzi	230,00 Per piece Al pezzo

 1,1 kg/pz
  12,8 Kg/m²
 1 box = 12 pieces
  14,7kg
  W. 41 D. 41 H. 9 cm

Excluding VAT
IVA esclusa



C18

**COPPER
RAME**

CODE / CODICE	IN	OUT	METAL FINISHES	MINIMUM ORDER/ORDINE MINIMO	EURO
DS712-C18	•		Copper Rame	C18 12 pieces/pezzi	280,00 Per piece Al pezzo

 1,2 kg/pz
  13,5 Kg/m²
 1 box = 12 pieces
  15,9 kg
  W. 41 D. 41 H. 9 cm

Excluding VAT
IVA esclusa

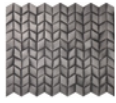
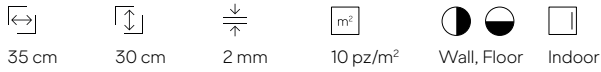

C22

**STAINLESS STEEL
ACCIAIO INOX**

CODE / CODICE	IN	OUT	METAL FINISHES	MINIMUM ORDER/ORDINE MINIMO	EURO
DS712-C22	•		Stainless steel Acciaio inox	C19 10 pieces/pezzi	195,00 Per piece Al pezzo

1,25 kg/pz 12 Kg/m² 1 box = 10 pieces 14 kg W. 41 D. 41 H. 9 cm

Excluding VAT
IVA esclusa



C20

**BRASS
OTTONE**

CODE / CODICE	IN	OUT	METAL FINISHES	MINIMUM ORDER/ORDINE MINIMO	EURO
DS713-C20	•		Brass Ottone	C22 10 pieces/pezzi	240,00 Per piece Al pezzo

1,3 kg/pz 12,8 Kg/m² 1 box = 10 pieces 14,5 kg W. 41 D. 41 H. 9 cm

Excluding VAT
IVA esclusa



C21

**COPPER
RAME**

CODE / CODICE	IN	OUT	METAL FINISHES	MINIMUM ORDER/ORDINE MINIMO	EURO
DS713-C21	•		Copper Rame	C21 10 pieces/pezzi	290,00 Per piece Al pezzo

1,35 kg/pz 13,5 Kg/m² 1 box = 10 pieces 15 kg W. 41 D. 41 H. 9 cm

Excluding VAT
IVA esclusa

Square 30

DESIGN BY R&D DE CASTELLI

Square mosaic of variable thickness pre-assembled on fiberglass mesh to form a tile with butt-jointed installation.

Mosaico quadrato di spessore variabile preassemblato su rete in fibra di vetro a formare una mattonella con installazione a giunto unito.

Square 30
DCS707

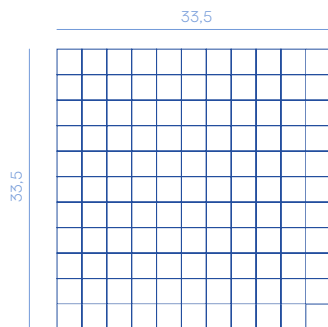

PRODUCT SPECIFICATION

Limits	<ul style="list-style-type: none"> – Shower cabin and areas in direct contact with water excluded – Bathroom and kitchen backsplash are not recommended
Details	<ul style="list-style-type: none"> – 30x30 mm square pieces featuring varying thickness – Minimum order 10 tiles – 10 tiles are required to clad 1 m²
Packaging	<ul style="list-style-type: none"> – Carton box TYPE E – Max 10 pieces each box
Installation	<ul style="list-style-type: none"> – Butt-jointed mosaic pre-assembled on a fiberglass mesh – It can be installed using epoxy adhesives – It can be processed on site with suitable tools, refer to Installation Manual for procedures and details

SPECIFICHE PRODOTTO





Limits	<ul style="list-style-type: none"> – Escluso box doccia e zone a diretto contatto con l'acqua – Si sconsiglia l'utilizzo in bagno e come paraschizzi della cucina
Dettagli	<ul style="list-style-type: none"> – Pezzi quadrati 30x30 di spessore variabile – Ordine minimo 10 piastrelle – Per rivestire 1 m² sono necessarie 10 piastrelle
Imballaggio	<ul style="list-style-type: none"> – Scatola di cartone TIPO E – Max 10 pezzi per scatola
Installazione	<ul style="list-style-type: none"> – Piastrella di mosaico a giunto unito preassemblata su rete in fibra di vetro – Può essere installato utilizzando adesivi e stucchi epossidici – Può essere lavorato in cantiere con attrezzi idonei, fare riferimento al Manuale di Installazione per procedure e dettagli

REGULATIONS

	Standard	Requisites	Results
Coeff. di dilatazione termica lineare	ISO 10545-8	from 25°C to 100°C (10-6 °C-1)	17,1 (Copper)
Resistance to chemical products for housekeeping	ISO 10545-13	A - B - C	A
Stain resistance	ISO 10545-14	1 - 5	Test method certificate available on request
Accelerated aging with UV lamp	ASTM G 145-16	Exposure time 500 hours	Gray scale evaluation: 4/5 slight variation in surface gloss and slight variation in color

NORMATIVE

	Standard	Requisites	Results
Coeff. di dilatazione termica lineare	ISO 10545-8	from 25°C to 100°C (10-6 °C-1)	17,1 (Rame)
Resistenza ai prodotti chimici di uso domestico	ISO 10545-13	A - B - C	A
Resistenza alle macchie	ISO 10545-14	1 - 5	Certificato metodo di prova disponibile su richiesta
Invecchiamento accelerato con lampada UV	ASTM G 145-16	Tempo di esposizione 500 ore	Valutazione scala di grigi: 4/5 lieve variazione di lucentezza superficiale e lieve variazione di colore

 33,5 cm
  33,5 cm
  2 mm
  10 pz/m²
  Wall, Floor
  Indoor

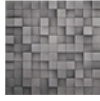

C15

**STAINLESS STEEL
ACCIAIO INOX**

CODE / CODICE	IN	OUT	METAL FINISHES	MINIMUM ORDER/ORDINE MINIMO	EURO
DS707-C15	•		Stainless steel Acciaio inox	C15 10 pieces/pezzi	160,00 Per piece Al pezzo

 1,35 kg/pz
  12 Kg/m²
 1 box = 10 pieces
  15 kg
  W. 41 D. 41 H. 9 cm

Excluding VAT
IVA esclusa



C13

**BRASS
OTTONE**

CODE / CODICE	IN	OUT	METAL FINISHES	MINIMUM ORDER/ORDINE MINIMO	EURO
DS707-C13	•		Brass Ottone	C13 10 pieces/pezzi	210,00 Per piece Al pezzo

 1,45 kg/pz
  12,8 Kg/m²
 1 box = 10 pieces
  16 kg
  W. 41 D. 41 H. 9 cm

Excluding VAT
IVA esclusa



C14

**COPPER
RAME**

CODE / CODICE	IN	OUT	METAL FINISHES	MINIMUM ORDER/ORDINE MINIMO	EURO
DS707-C14	•		Copper Rame	C14 10 pieces/pezzi	265,00 Per piece Al pezzo

 1,5 kg/pz
  13,5 Kg/m²
 1 box = 10 pieces
  16,5 kg
  W. 41 D. 41 H. 9 cm

Excluding VAT
IVA esclusa

METAL MIX

On request Su richiesta	Mixed materials, subject to confirmation of feasibility by De Castelli Mix di materiali, previa conferma fattibilità da parte di De Castelli	DS707-C14 +15%
--	---	-----------------------

Excluding VAT
IVA esclusa

Square 50

DESIGN BY R&D DE CASTELLI

Square mosaic of variable thickness pre-assembled on fiberglass mesh to form a tile with butt-jointed installation.

Mosaico quadrato di spessore variabile preassemblato su rete in fibra di vetro a formare una mattonella con installazione a giunto unito.

Square 50
DCS709

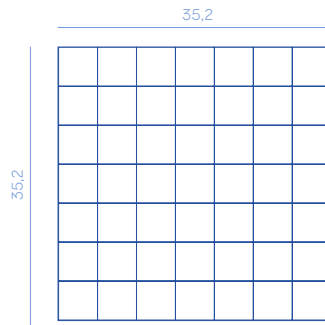

PRODUCT SPECIFICATION

Limits	<ul style="list-style-type: none"> - Shower cabin and areas in direct contact with water excluded - Bathroom and kitchen backsplash are not recommended
Details	<ul style="list-style-type: none"> - 50x50 mm square pieces punched on sides featuring varying thickness - Minimum order 9 tiles - 9 tiles are required to clad 1 m²
Packaging	<ul style="list-style-type: none"> - Carton box TYPE E - Max 9 pieces each box
Installation	<ul style="list-style-type: none"> - Butt-jointed mosaic pre-assembled on a fiberglass mesh - It can be installed using epoxy adhesives - It can be processed on site with suitable tools, refer to Installation Manual for procedures and details

SPECIFICHE PRODOTTO

Limits	<ul style="list-style-type: none"> - Escluso box doccia e zone a diretto contatto con l'acqua - Si sconsiglia l'utilizzo in bagno e come paraschizzi della cucina
Dettagli	<ul style="list-style-type: none"> - Pezzi quadrati 50x50 mm di spessore variabile - Ordine minimo 9 piastrelle - Per rivestire 1 m² sono necessarie 9 piastrelle
Imballaggio	<ul style="list-style-type: none"> - Scatola di cartone TIPO E - Max 9 pezzi per scatola
Installazione	<ul style="list-style-type: none"> - Piastrella di mosaico a giunto unito preassemblata su rete in fibra di vetro - Può essere installato utilizzando adesivi e stucchi epossidici - Può essere lavorato in cantiere con attrezzi idonei, fare riferimento al Manuale di Installazione per procedure e dettagli

REGULATIONS

	Standard	Requisites	Results
Coeff. di dilatazione termica lineare	ISO 10545-8	from 25°C to 100°C (10-6 °C-1)	17,1 (Copper)
Resistance to chemical products for housekeeping	ISO 10545-13	A - B - C	A
Stain resistance	ISO 10545-14	1 - 5	Test method certificate available on request
Accelerated aging with UV lamp	ASTM G 145-16	Exposure time 500 hours	Gray scale evaluation: 4/5 slight variation in surface gloss and slight variation in color

NORMATIVE

	Standard	Requisites	Results
Coeff. di dilatazione termica lineare	ISO 10545-8	from 25°C to 100°C (10-6 °C-1)	17,1 (Rame)
Resistenza ai prodotti chimici di uso domestico	ISO 10545-13	A - B - C	A
Resistenza alle macchie	ISO 10545-14	1 - 5	Certificato metodo di prova disponibile su richiesta
Invecchiamento accelerato con lampada UV	ASTM G 145-16	Tempo di esposizione 500 ore	Valutazione scala di grigi: 4/5 lieve variazione di lucentezza superficiale e lieve variazione di colore

DIAMOND 30

 35,2 cm
  35,2 cm
  2 mm
  9 pz/m²
  Wall, Floor
  Indoor

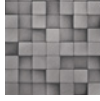

C6

STAINLESS STEEL
ACCIAIO INOX

CODE / CODICE	IN	OUT	METAL FINISHES	MINIMUM ORDER/ORDINE MINIMO	EURO
DS709-C6	•		Stainless steel Acciaio inox	9 pieces/pezzi	150,00 Per piece Al pezzo

 1,5 kg/pz
  12 Kg/m²
 1 box = 9 pieces
  15 kg
  W. 41 D. 41 H. 9 cm

Excluding VAT
IVA esclusa



C4

BRASS
OTTONE

CODE / CODICE	IN	OUT	METAL FINISHES	MINIMUM ORDER/ORDINE MINIMO	EURO
DS709-C4	•		Brass Ottone	9 pieces/pezzi	200,00 Per piece Al pezzo

 1,6 kg/pz
  12,8 Kg/m²
 1 box = 9 pieces
  15,7 kg
  W. 41 D. 41 H. 9 cm

Excluding VAT
IVA esclusa

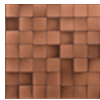

C5

COPPER
RAME

CODE / CODICE	IN	OUT	METAL FINISHES	MINIMUM ORDER/ORDINE MINIMO	EURO
DS709-C5	•		Copper Rame	9 pieces/pezzi	250,00 Per piece Al pezzo

 1,65 kg/pz
  13,5 Kg/m²
 1 box = 9 pieces
  16,4 kg
  W. 41 D. 41 H. 9 cm

Excluding VAT
IVA esclusa

METAL MIX

On request Su richiesta	Mixed materials, subject to confirmation of feasibility by De Castelli Mix di materiali, previa conferma fattibilità da parte di De Castelli	DS709-C5 +15%
--	---	----------------------

Excluding VAT
IVA esclusa

Decorative
Decorativi

3D Wall

DESIGN BY R&D DE CASTELLI

Decorative wall cladding module with trapezoidal-section and magnetic fixing system to iron panel to be defined on project basis. The composition can be freely configured.

Modulo decorativo di rivestimento a parete a sezione trapezoidale con sistema di fissaggio magnetico a un pannello in ferro da definire in base al progetto. La composizione è liberamente configurabile.

DS704

Module/Modulo

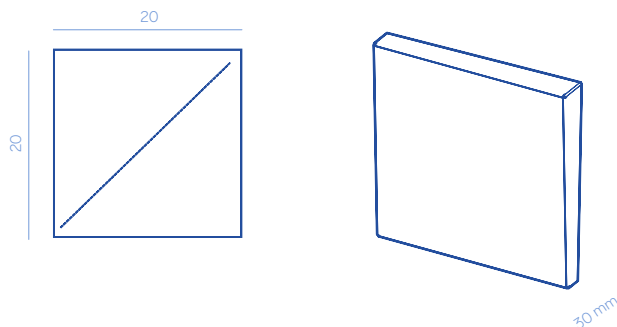

PRODUCT SPECIFICATION

Limits	<ul style="list-style-type: none"> – Shower cabin and areas in direct contact with water excluded – Bathroom and kitchen backsplash are not recommended
Details	<ul style="list-style-type: none"> – Trapezoidal-section module – Panel, to be defined on project basis, included – Minimum order 25 modules – 25 modules are required to clad 1 m² – Wall specifications are mandatory in order to check the feasibility of the cladding system
Packaging	– To be quoted at order confirmation
Installation	<ul style="list-style-type: none"> – Magnetic fixing system on iron panel to be mechanically fixed on wall – Magnets included, fixing screws excluded

SPECIFICHE PRODOTTO

Limits	<ul style="list-style-type: none"> – Escluso box doccia e zone a diretto contatto con l'acqua – Si sconsiglia l'utilizzo in bagno e come paraschizzi della cucina
Dettagli	<ul style="list-style-type: none"> – Modulo a sezione trapezoidale – Pannello, da definire in base al progetto, incluso – Ordine minimo 25 moduli – Per rivestire 1 m² sono necessari 25 moduli – Le specifiche delle pareti sono obbligatorie per verificare la fattibilità del sistema di rivestimento
Imballaggio	– Da quotare alla conferma d'ordine
Installazione	<ul style="list-style-type: none"> – Sistema di fissaggio magnetico su pannello in ferro da fissare meccanicamente a parete – Magneti inclusi, viti di fissaggio escluse

REGULATIONS

	Standard	Requisites	Results
Linear thermal expansion coeff.	ISO 10545-8	from 25°C to 100°C (10-6 °C-1)	17,1 (Copper)
Resistance to chemical products for housekeeping	ISO 10545-13	A - B - C	A
Stain resistance	ISO 10545-14	1 - 5	Test method certificate available on request
Accelerated aging with UV lamp	ASTM G 145-16	Exposure time 500 hours	Gray scale evaluation: 4/5 slight variation in surface gloss and slight variation in color

NORMATIVE

	Standard	Requisites	Results
Coeff. di dilatazione termica lineare	ISO 10545-8	from 25°C to 100°C (10-6 °C-1)	17,1 (Rame)
Resistenza ai prodotti chimici di uso domestico	ISO 10545-13	A - B - C	A
Resistenza alle macchie	ISO 10545-14	1 - 5	Certificato metodo di prova disponibile su richiesta
Invecchiamento accelerato con lampada UV	ASTM G 145-16	Tempo di esposizione 500 ore	Valutazione scala di grigi: 4/5 lieve variazione di lucentezza superficiale e lieve variazione di colore

COMPOSITION

Type of composition, application and installation to be defined based on specific project requirements.

The information you need to provide for the development of the projects are:

- Reference and contact details of the project manager
- Intended use of the project space (residential / public)
- Type of environment and particular weather conditions (indoor, outdoor, sea front, etc.)
- Description of the current state of the project space and wall composition (concrete, wood, plasterboard)
- Drawings with dimensions (DWG, PDF or 3D)
- De Castelli materials and finishes choices accompanied by the corresponding code
- Estimated date of project completion

COMPOSIZIONE

Tipologia di composizione, applicazione ed installazione da definire a progetto.

Ai fini della definizione del progetto sono richieste le seguenti informazioni:

- Riferimenti e recapiti del responsabile di progetto
- Destinazione d'uso dello spazio di progetto (residenziale/pubblico)
- Tipologia di ambiente e condizioni metereologiche particolari (interno, esterno, fronte mare, ecc)
- Descrizione dello stato di fatto e composizione muraria (cemento, legno, cartongesso)
- Disegni quotati (DWG, PDF o 3D)
- Indicazione di materiali e finiture De Castelli corredate da codice corrispondente
- Data prevista per il completamento del progetto

Composition example
Composizione tipo

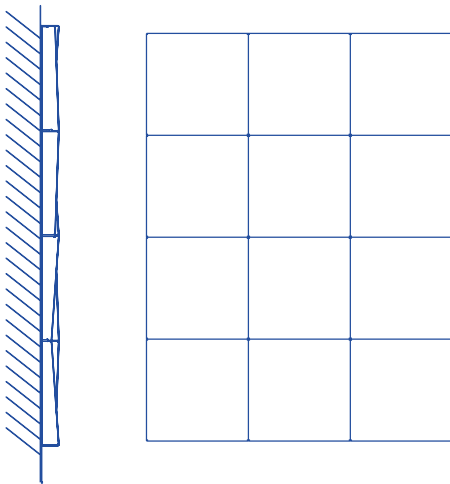

Fixing system
Sistema di fissaggio

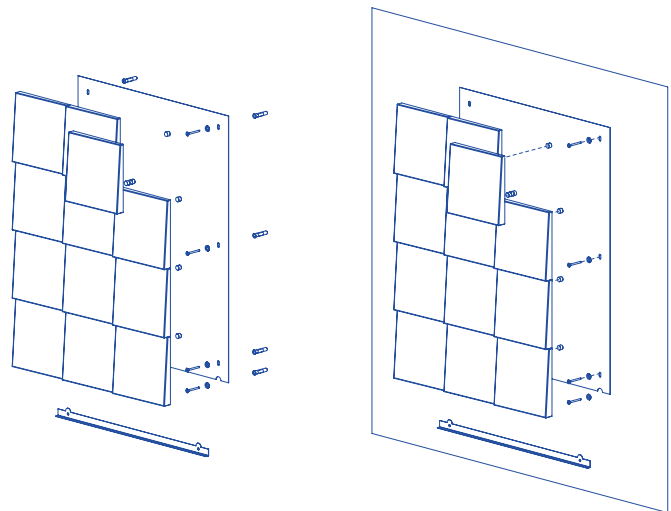

3D WALL



As per project
Da progetto



30 mm



25 pz/m²



Wall
Parete



Indoor

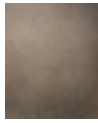

G12



E5

STAINLESS STEEL ACCIAIO INOX

CODE / CODICE	IN	OUT	METAL FINISHES	MINIMUM ORDER/ORDINE MINIMO	EURO
DS704-E5	•		Stainless steel Acciaio inox DeLabré B DeLabré B	E5 25 pieces/pezzi	98,00 Per piece Al pezzo
DS704-G12	•		Stainless steel Acciaio inox DeDeep DeDeep	G12 25 pieces/pezzi	110,00 Per piece Al pezzo

[On request](#)
[Su richiesta](#)

Other finishes on stainless steel, subject to confirmation of feasibility by De Castelli
Altre finiture su acciaio inox, previa conferma fattibilità da parte di De Castelli

DS704-G12 **+15%**

21,7 Kg/m²

Excluding VAT
IVA esclusa

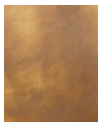

F2

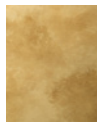

M7

BRASS OTTONE

CODE / CODICE	IN	OUT	METAL FINISHES	MINIMUM ORDER/ORDINE MINIMO	EURO
DS704-F2	•		Brass Ottone DeLabré DeLabré	F2 25 pieces/pezzi	120,00 Per piece Al pezzo
DS704-M7	•		Brass Ottone DeSalt DeSalt	M7 25 pieces/pezzi	130,00 Per piece Al pezzo

[On request](#)
[Su richiesta](#)

Other finishes on brass, subject to confirmation of feasibility by De Castelli
Altre finiture su ottone, previa conferma fattibilità da parte di De Castelli

DS704-M7 **+15%**

21,7 Kg/m²

Excluding VAT
IVA esclusa



G5

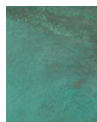

F7

COPPER RAME

CODE / CODICE	IN	OUT	METAL FINISHES	MINIMUM ORDER/ORDINE MINIMO	EURO
DS704-G5	•		Copper Rame DeLabré DeLabré	G5 25 pieces/pezzi	140,00 Per piece Al pezzo
DS704-F7	•		Copper Rame Verdigris Verderame	F7 25 pieces/pezzi	160,00 Per piece Al pezzo

[On request](#)
[Su richiesta](#)

Other finishes on copper, subject to confirmation of feasibility by De Castelli
Altre finiture su rame, previa conferma fattibilità da parte di De Castelli

DS704-F7 **+15%**

21,7 Kg/m²

Excluding VAT
IVA esclusa

Circle Wall

DESIGN BY R&D DE CASTELLI

Decorative wall cladding module with circular shape. The modules are pre-assembled on wall-mounting brackets on project basis.

Modulo decorativo di rivestimento a parete di forma circolare. I moduli sono preassemblati su staffe per il fissaggio a parete secondo progetto.

DS701

Module/Modulo

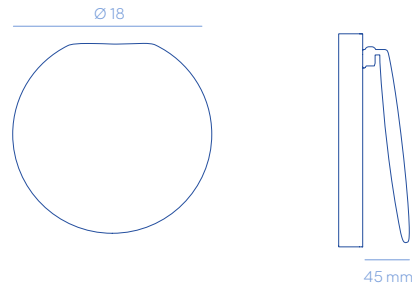

Specify in the order if for indoor or outdoor.

Specificare nell'ordine se per uso interno o esterno.

PRODUCT SPECIFICATION

Limits	<ul style="list-style-type: none"> – Shower cabin and areas in direct contact with water excluded – Bathroom and kitchen backsplash are not recommended
Details	<ul style="list-style-type: none"> – Rounded module pre-assembled on brackets as per project ordered – Minimum order 44 modules – 44 modules are required to clad 1 m² – Four bracket options – RAL 9010 or 9005 lacquered brackets to be specified at order confirmation – Wall specifications are mandatory in order to check the feasibility of the cladding system
Packaging	<ul style="list-style-type: none"> – To be quoted at order confirmation
Installation	<ul style="list-style-type: none"> – Wall-mounting brackets system – Brackets included, fixing screws excluded – A template for the correct assembly is provided

SPECIFICHE PRODOTTO

Limiti	<ul style="list-style-type: none"> – Escluso box doccia e zone a diretto contatto con l'acqua – Si sconsiglia l'utilizzo in bagno e come paraschizzi della cucina
Dettagli	<ul style="list-style-type: none"> – Modulo tondo pre-montato su staffe come da progetto ordinato – Ordine minimo 44 moduli – Per rivestire 1 m² sono necessari 44 moduli – Quattro opzioni di staffe – Staffe laccate RAL 9010 o 9005 da specificare alla conferma dell'ordine – Le specifiche delle pareti sono obbligatorie per verificare la fattibilità del sistema di rivestimento
Imballaggio	<ul style="list-style-type: none"> – Da quotare alla conferma d'ordine
Installazione	<ul style="list-style-type: none"> – Sistema di staffe per fissaggio a parete – Staffe incluse, viti di fissaggio escluse – Viene fornita una dima per il corretto montaggio

REGULATIONS

	Standard	Requisites	Results
Linear thermal expansion coeff.	ISO 10545-8	from 25°C to 100°C (10-6 °C-1)	17,1 (Copper)
Resistance to chemical products for housekeeping	ISO 10545-13	A - B - C	A
Stain resistance	ISO 10545-14	1 - 5	Test method certificate available on request
Accelerated aging with UV lamp	ASTM G 145-16	Exposure time 500 hours	Gray scale evaluation: 4/5 slight variation in surface gloss and slight variation in color

NORMATIVE

	Standard	Requisites	Results
Coeff. di dilatazione termica lineare	ISO 10545-8	from 25°C to 100°C (10-6 °C-1)	17,1 (Rame)
Resistenza ai prodotti chimici di uso domestico	ISO 10545-13	A - B - C	A
Resistenza alle macchie	ISO 10545-14	1 - 5	Certificato metodo di prova disponibile su richiesta
Invecchiamento accelerato con lampada UV	ASTM G 145-16	Tempo di esposizione 500 ore	Valutazione scala di grigi: 4/5 lieve variazione di lucentezza superficiale e lieve variazione di colore

COMPOSITION

Type of composition, application and installation to be defined based on specific project requirements.

The information you need to provide for the development of the projects are:

- Reference and contact details of the project manager
- Intended use of the project space (residential / public)
- Type of environment and particular weather conditions (indoor, outdoor, sea front, etc.)
- Description of the current state of the project space and wall composition (concrete, wood, plasterboard)
- Drawings with dimensions (DWG, PDF or 3D)
- De Castelli materials and finishes choices accompanied by the corresponding code (see the abacus finishes at the end of the catalog or on the website at the link <https://www.decastelli.com/en/materials/>)
- Estimated date of project completion
- Bracket color indication to be chosen between RAL 9010 or RAL 9005

Brackets modules
Moduli di staffe

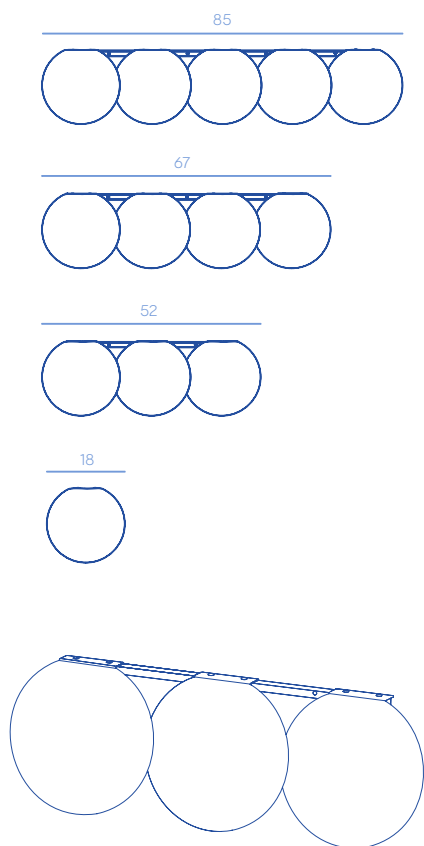

COMPOSIZIONE

Tipologia di composizione, applicazione ed installazione da definire a progetto.

Ai fini della definizione del progetto sono richieste le seguenti informazioni:

- Riferimenti e recapiti del responsabile di progetto
- Destinazione d'uso dello spazio di progetto (residenziale/pubblico)
- Tipologia di ambiente e condizioni metereologiche particolari (interno, esterno, fronte mare, ecc)
- Descrizione dello stato di fatto e composizione muraria (cemento, legno, cartongesso)
- Disegni quotati (DWG, PDF o 3D)
- Indicazione di materiali e finiture De Castelli corrispondente (si veda abaco finiture a fine catalogo o sul sito al link <https://www.decastelli.com/materiali/>)
- Data prevista per il completamento del progetto
- Indicazione colore staffe a scelta fra RAL 9010 o RAL 9005



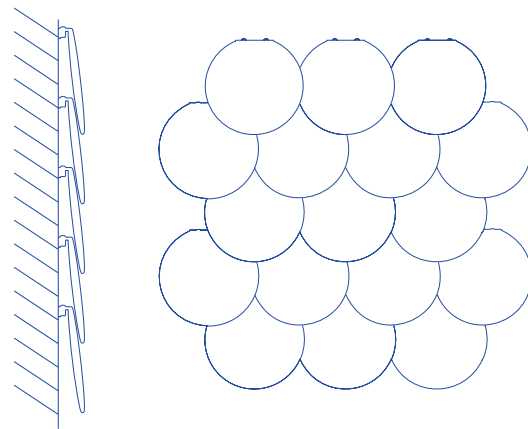

Composition example
Composizione tipo

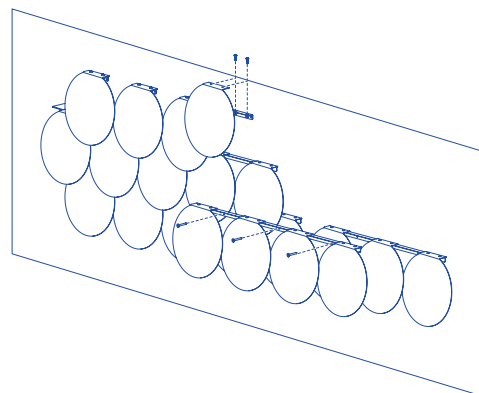

Fixing system
Sistema di fissaggio



CIRCLE WALL

 As per project
  Min 45 mm
  44 pz/m²
  Wall
  Indoor, Outdoor

 RAL 9010 or 9005 lacquered brackets to be specified at order confirmation.
 Staffe laccate RAL 9010 o 9005 da specificare alla conferma dell'ordine.

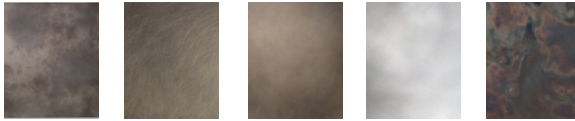

E11 G2 E5 M11 M0

**STAINLESS STEEL
ACCIAIO INOX**

CODE / CODICE	IN	OUT	METAL FINISHES				MINIMUM ORDER/ORDINE MINIMO	EURO	
DS701-E11	•		x44	Stainless steel Acciaio inox	DeLabré DeLabré	E11	1 m ²	1.850,00	Per m ² Al m ²
DS701-G2	•		x44	Stainless steel Acciaio inox	Orbitale DeLabré DeLabré orbitale	G2	1 m ²	1.850,00	Per m ² Al m ²
DS701-E5	•		x44	Stainless steel Acciaio inox	DeLabré B DeLabré B	E5	1 m ²	1.850,00	Per m ² Al m ²
DS701-M11	•		x44	Stainless steel Acciaio inox	Brushed Spazzolato	M11	1 m ²	1.850,00	Per m ² Al m ²
DS701-M0	•		x44	Stainless steel Acciaio inox	DeOpale DeOpale	M0	1 m ²	1.850,00	Per m ² Al m ²
DS701-MIX-IX	•		x10	Stainless steel Acciaio inox	DeLabré DeLabré	E11	1 m ²	2.300,00	Per m ² Al m ²
			x10	Stainless steel Acciaio inox	Orbitale DeLabré DeLabré orbitale	G2			
			x10	Stainless steel Acciaio inox	DeLabré B DeLabré B	E5			
			x7	Stainless steel Acciaio inox	Brushed Spazzolato	M11			
			x7	Stainless steel Acciaio inox	DeOpale DeOpale	M0			

 11,8 Kg/m²

Excluding VAT
IVA esclusa

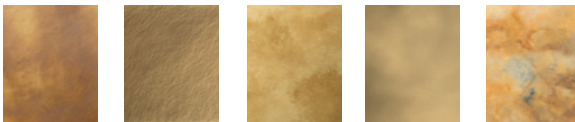

F2 G3 M7 M9 M3

**BRASS
OTTONE**

CODE / CODICE	IN	OUT	METAL FINISHES				MINIMUM ORDER/ORDINE MINIMO	EURO	
DS701-F2	•		x44	Brass Ottone	DeLabré DeLabré	F2	1 m ²	2.550,00	Per m ² Al m ²
DS701-G3	•		x44	Brass Ottone	Orbitale DeLabré DeLabré orbitale	G3	1 m ²	2.550,00	Per m ² Al m ²
DS701-M7	•		x44	Brass Ottone	DeSalt DeSalt	M7	1 m ²	2.550,00	Per m ² Al m ²
DS701-M9	•		x44	Brass Ottone	Brushed Spazzolato	M9	1 m ²	2.550,00	Per m ² Al m ²
DS701-M3	•		x44	Brass Ottone	DeOpale DeOpale	M3	1 m ²	2.550,00	Per m ² Al m ²
DS701-MIX-OT	•		x10	Brass Ottone	DeLabré DeLabré	F2	1 m ²	3.100,00	Per m ² Al m ²
			x10	Brass Ottone	Orbitale DeLabré DeLabré orbitale	G3			
			x10	Brass Ottone	DeSalt DeSalt	M7			
			x7	Brass Ottone	Brushed Spazzolato	M9			
			x7	Brass Ottone	DeOpale DeOpale	M3			

 11,8 Kg/m²

Excluding VAT
IVA esclusa

CIRCLE WALL



On design



Min 45 mm



44 pz/m²



Wall



Indoor, Outdoor



RAL 9010 or 9005 lacquered brackets to be specified at order confirmation.
Staffe laccate RAL 9010 o 9005 da specificare alla conferma dell'ordine.

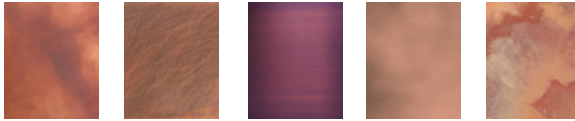

G5

G4

G11

M10

M2

COPPER RAME

CODE / CODICE	IN	OUT	METAL FINISHES				MINIMUM ORDER/ORDINE MINIMO	EURO	
DS701-G5	•		x44	Copper Rame	DeLabré DeLabré	G5	1 m ²	2.750,00	Per m ² Al m ²
DS701-G4	•		x44	Copper Rame	Orbitale DeLabré DeLabré orbitale	G4	1 m ²	2.750,00	Per m ² Al m ²
DS701-G11	•		x44	Copper Rame	Rubin Rubino	G11	1 m ²	2.750,00	Per m ² Al m ²
DS701-M10	•		x44	Copper Rame	Brushed Spazzolato	M10	1 m ²	2.750,00	Per m ² Al m ²
DS701-M2	•		x44	Copper Rame	DeOpale DeOpale	M2	1 m ²	2.750,00	Per m ² Al m ²
DS701-MIX-RA	•		x10	Copper Rame	DeLabré DeLabré	G5	1 m ²	3.400,00	Per m ² Al m ²
			x10	Copper Rame	Orbitale DeLabré DeLabré orbitale	G4			
			x10	Copper Rame	Rubin Rubino	G11			
			x7	Copper Rame	Brushed Spazzolato	M10			
			x7	Copper Rame	DeOpale DeOpale	M2			

11,8 Kg/m²

Excluding VAT
IVA esclusa

DecoDe

DESIGN BY PINO SCAGLIONE

Decorative wall cladding module with hexagonal shape with sound-absorbing properties.

Modulo decorativo di rivestimento murale di forma esagonale con proprietà fonoassorbenti.

DS705-A
Module/Modulo

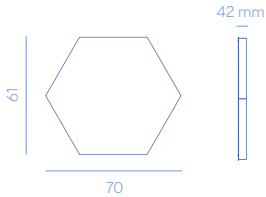

DS705-B
Module/Modulo

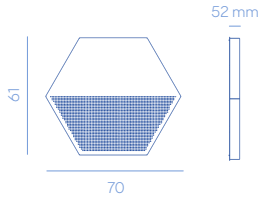

DS705-C
Module/Modulo

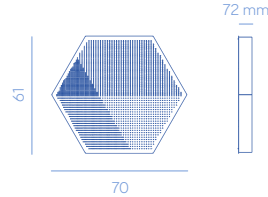

DS705-D
Module/Modulo

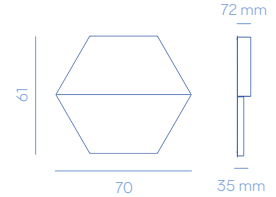

PRODUCT SPECIFICATION

Limits	<ul style="list-style-type: none"> – Shower cabin and areas in direct contact with water excluded – Bathroom and kitchen backsplash are not recommended
Details	<ul style="list-style-type: none"> – Four hexagonal modules, smooth or punched as per drawings, with sound-absorbing properties compliant with Class D of the EN ISO 11654 standards on Sound Absorption – Absorption coefficient equal to Alfa=0,30 LM with acoustic absorption curve that varies between Alfa 0,30 LM and Alfa 0,60 LM – Certificate available upon request – 4 modules are required to clad 1 m² – Wall specifications are mandatory in order to check the feasibility of the cladding system
Packaging	– To be quoted at order confirmation
Installation	<ul style="list-style-type: none"> – Wall-mounting brackets system – Brackets included, fixing screws excluded

SPECIFICHE PRODOTTO

Limits	<ul style="list-style-type: none"> – Escluso box doccia e zone a diretto contatto con l'acqua – Si sconsiglia l'utilizzo in bagno e come paraschizzi della cucina
Dettagli	<ul style="list-style-type: none"> – Quattro moduli esagonali, lisci o fustellati a disegno, con proprietà fonoassorbenti conformi alla Classe D della norma EN ISO 11654 sul Fonoassorbimento – Coefficiente di assorbimento pari ad Alfa=0,30 LM con curva di assorbimento acustico che varia tra Alfa 0,30 LM e Alfa 0,60 LM – Certificato disponibile su richiesta – Per rivestire 1 m² sono necessari 4 moduli – Le specifiche delle pareti sono obbligatorie per verificare la fattibilità del sistema di rivestimento
Imballaggio	– Da quotare alla conferma d'ordine
Installazione	<ul style="list-style-type: none"> – Sistema di staffe per fissaggio a parete – Staffe incluse, viti di fissaggio escluse

REGULATIONS

	Standard	Requisites	Results
Linear thermal expansion coeff.	ISO 10545-8	from 25°C to 100°C (10-6 °C-1)	17,1 (Copper)
Resistance to chemical products for housekeeping	ISO 10545-13	A - B - C	A
Stain resistance	ISO 10545-14	1 - 5	Test method certificate available on request
Accelerated aging with UV lamp	ASTM G 145-16	Exposure time 500 hours	Gray scale evaluation: 4/5 slight variation in surface gloss and slight variation in color

NORMATIVE

	Standard	Requisites	Results
Coeff. di dilatazione termica lineare	ISO 10545-8	from 25°C to 100°C (10-6 °C-1)	17,1 (Rame)
Resistenza ai prodotti chimici di uso domestico	ISO 10545-13	A - B - C	A
Resistenza alle macchie	ISO 10545-14	1 - 5	Certificato metodo di prova disponibile su richiesta
Invecchiamento accelerato con lampada UV	ASTM G 145-16	Tempo di esposizione 500 ore	Valutazione scala di grigi: 4/5 lieve variazione di lucentezza superficiale e lieve variazione di colore

COMPOSITION

Type of composition, application and installation to be defined based on specific project requirements.

The information you need to provide for the development of the projects are:

- Reference and contact details of the project manager
- Intended use of the project space (residential / public)
- Type of environment and particular weather conditions (indoor, outdoor, sea front, etc.)
- Description of the current state of the project space and wall composition (concrete, wood, plasterboard)
- Drawings with dimensions (DWG, PDF or 3D)
- De Castelli materials and finishes choices accompanied by the corresponding code (see the abacus finishes at the end of the catalog or on the website at the link <https://www.decastelli.com/en/materials/>)
- Estimated date of project completion

Composition example
Composizione tipo

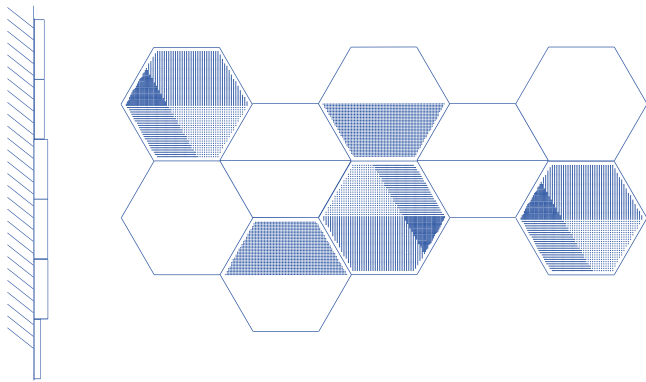

COMPOSIZIONE

Tipologia di composizione, applicazione ed installazione da definire a progetto.

Ai fini della definizione del progetto sono richieste le seguenti informazioni:

- Riferimenti e recapiti del responsabile di progetto
- Destinazione d'uso dello spazio di progetto (residenziale/pubblico)
- Tipologia di ambiente e condizioni metereologiche particolari (interno, esterno, fronte mare, ecc)
- Descrizione dello stato di fatto e composizione muraria (cemento, legno, cartongesso)
- Disegni quotati (DWG, PDF o 3D)
- Indicazione di materiali e finiture De Castelli corredate da codice corrispondente (si veda abaco finiture a fine catalogo o sul sito al link <https://www.decastelli.com/materiali/>)
- Data prevista per il completamento del progetto

Fixing system
Sistema di fissaggio

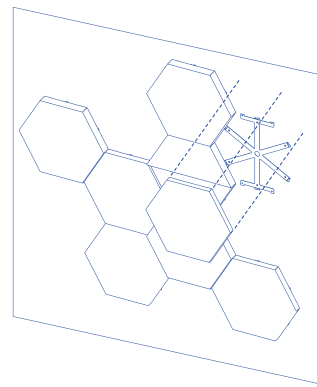

DECODE A

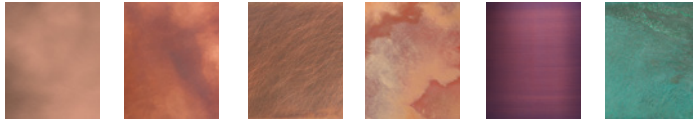
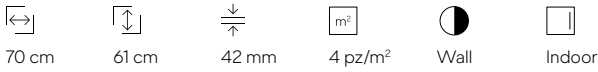

M10 G5 G4 M2 G11 F7

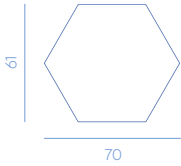

CODE / CODICE	IN	OUT	METAL FINISHES			MINIMUM ORDER/ORDINE MINIMO	EURO	
DS705-A-M10	•		Copper Rame	Brushed Spazzolato	M10	1 piece/pezzo	990,00	Per piece Al pezzo
DS705-A-G5	•		Copper Rame	DeLabré DeLabré	G5	1 piece/pezzo	1.000,00	Per piece Al pezzo
DS705-A-G4	•		Copper Rame	Orbitale DeLabré DeLabré orbitale	G4	1 piece/pezzo	1.100,00	Per piece Al pezzo
DS705-A-M2	•		Copper Rame	DeOpale DeOpale	M2	1 piece/pezzo	1.00,00	Per piece Al pezzo
DS705-A-G11	•		Copper Rame	Rubin Rubino	G11	1 piece/pezzo	1.100,00	Per piece Al pezzo
DS705-A-F7	•		Copper Rame	Verdigris Verderame	F7	1 piece/pezzo	1.200,00	Per piece Al pezzo

5,5 kg/pz

Excluding VAT
IVA esclusa

DECODE B

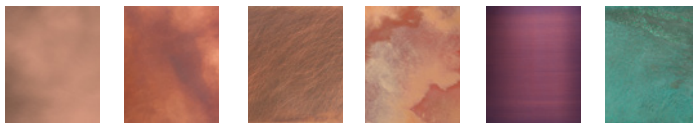
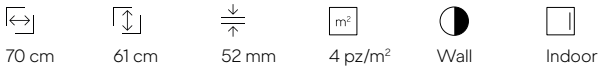

M10 G5 G4 M2 G11 F7

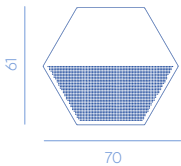

CODE / CODICE	IN	OUT	METAL FINISHES			MINIMUM ORDER/ORDINE MINIMO	EURO	
DS705-B-M10	•		Copper Rame	Brushed Spazzolato	M10	1 piece/pezzo	1.050,00	Per piece Al pezzo
DS705-B-G5	•		Copper Rame	DeLabré DeLabré	G5	1 piece/pezzo	1.100,00	Per piece Al pezzo
DS705-B-G4	•		Copper Rame	Orbitale DeLabré DeLabré orbitale	G4	1 piece/pezzo	1.150,00	Per piece Al pezzo
DS705-B-M2	•		Copper Rame	DeOpale DeOpale	M2	1 piece/pezzo	1.150,00	Per piece Al pezzo
DS705-B-G11	•		Copper Rame	Rubin Rubino	G11	1 piece/pezzo	1.150,00	Per piece Al pezzo
DS705-B-F7	•		Copper Rame	Verdigris Verderame	F7	1 piece/pezzo	1.300,00	Per piece Al pezzo

6,1 kg/pz

Excluding VAT
IVA esclusa

DECODE C

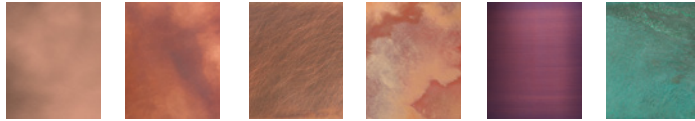
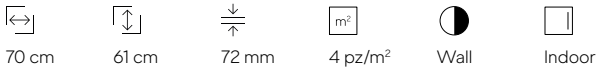

M10 G5 G4 M2 G11 F7

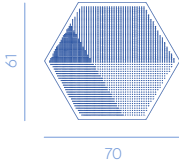

CODE / CODICE	IN	OUT	METAL FINISHES			MINIMUM ORDER/ORDINE MINIMO	EURO	
DS705-C-M10	•		Copper Rame	Brushed Spazzolato	M10	1 piece/pezzo	1.100,00	Per piece Al pezzo
DS705-C-G5	•		Copper Rame	DeLabré DeLabré	G5	1 piece/pezzo	1.180,00	Per piece Al pezzo
DS705-C-G4	•		Copper Rame	Orbitale DeLabré DeLabré orbitale	G4	1 piece/pezzo	1.250,00	Per piece Al pezzo
DS705-C-M2	•		Copper Rame	DeOpale DeOpale	M2	1 piece/pezzo	1.250,00	Per piece Al pezzo
DS705-C-G11	•		Copper Rame	Rubin Rubino	G11	1 piece/pezzo	1.250,00	Per piece Al pezzo
DS705-C-F7	•		Copper Rame	Verdigris Verderame	F7	1 piece/pezzo	1.350,00	Per piece Al pezzo

kg 6,8 kg/pz

Excluding VAT IVA esclusa

DECODE D

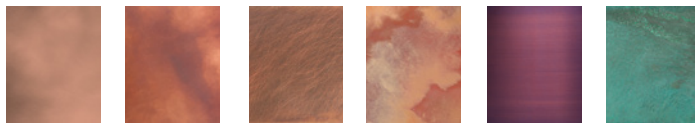
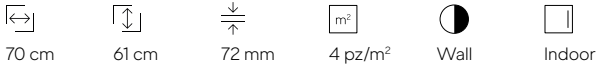

M10 G5 G4 M2 G11 F7

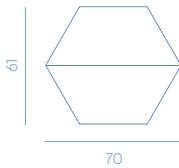

CODE / CODICE	IN	OUT	METAL FINISHES			MINIMUM ORDER/ORDINE MINIMO	EURO	
DS705-D-M10	•		Copper Rame	Brushed Spazzolato	M10	1 piece/pezzo	1.050,00	Per piece Al pezzo
DS705-D-G5	•		Copper Rame	DeLabré DeLabré	G5	1 piece/pezzo	1.150,00	Per piece Al pezzo
DS705-D-G4	•		Copper Rame	Orbitale DeLabré DeLabré orbitale	G4	1 piece/pezzo	1.200,00	Per piece Al pezzo
DS705-D-M2	•		Copper Rame	DeOpale DeOpale	M2	1 piece/pezzo	1.200,00	Per piece Al pezzo
DS705-D-G11	•		Copper Rame	Rubin Rubino	G11	1 piece/pezzo	1.200,00	Per piece Al pezzo
DS705-D-F7	•		Copper Rame	Verdigris Verderame	F7	1 piece/pezzo	1.300,00	Per piece Al pezzo

kg 6,4 kg/pz

Excluding VAT IVA esclusa

Vertical Green

DESIGN BY PINO SCAGLIONE

The DecoDe system comprises 4 copper modules. The hexagonal modules can be smooth or punched. Inside each module there is a mat of sound-absorbing material.

Il sistema DecoDe è composto da 4 moduli in rame. I moduli esagonali possono essere lisci o punzonati. All'interno di ogni modulo è inserito un materassino in materiale fonoassorbente.

DS700

Module/Modulo

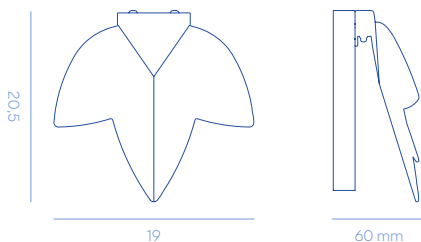

Specify in the order if for indoor or outdoor.

Specificare nell'ordine se per uso interno o esterno.

PRODUCT SPECIFICATION

Limits	<ul style="list-style-type: none"> - Shower cabin and areas in direct contact with water excluded - Bathroom and kitchen backsplash are not recommended
Details	<ul style="list-style-type: none"> - Leaf shape module pre-assembled on brackets as per project ordered - Minimum order 40 modules - 40 modules are required to clad 1 m² - Four bracket options - RAL 9010 or 9005 lacquered brackets to be specified at order confirmation - Wall specifications are mandatory in order to check the feasibility of the cladding system
Packaging	<ul style="list-style-type: none"> - To be quoted at order confirmation
Installation	<ul style="list-style-type: none"> - Wall-mounting brackets system - Brackets included, fixing screws excluded - A template for the correct assembly is provided

SPECIFICHE PRODOTTO

Limits	<ul style="list-style-type: none"> - Escluso box doccia e zone a diretto contatto con l'acqua - Si sconsiglia l'utilizzo in bagno e come paraschizzi della cucina
Dettagli	<ul style="list-style-type: none"> - Modulo a foglia pre-montato su staffe come da progetto ordinato - Ordine minimo 40 moduli - Per rivestire 1 m² sono necessari 40 moduli - Quattro opzioni di staffe - Staffe laccate RAL 9010 o 9005 da specificare alla conferma dell'ordine - Le specifiche delle pareti sono obbligatorie per verificare la fattibilità del sistema di rivestimento
Imballaggio	<ul style="list-style-type: none"> - Da quotare alla conferma d'ordine
Installazione	<ul style="list-style-type: none"> - Sistema di staffe per fissaggio a parete - Staffe incluse, viti di fissaggio escluse - Viene fornita una dima per il corretto montaggio

REGULATIONS

	Standard	Requisites	Results
Linear thermal expansion coeff.	ISO 10545-8	from 25°C to 100°C (10-6 °C-1)	17,1 (Copper)
Resistance to chemical products for housekeeping	ISO 10545-13	A - B - C	A
Stain resistance	ISO 10545-14	1 - 5	Test method certificate available on request
Accelerated aging with UV lamp	ASTM G 145-16	Exposure time 500 hours	Gray scale evaluation: 4/5 slight variation in surface gloss and slight variation in color

NORMATIVE

	Standard	Requisites	Results
Coeff. di dilatazione termica lineare	ISO 10545-8	from 25°C to 100°C (10-6 °C-1)	17,1 (Rame)
Resistenza ai prodotti chimici di uso domestico	ISO 10545-13	A - B - C	A
Resistenza alle macchie	ISO 10545-14	1 - 5	Certificato metodo di prova disponibile su richiesta
Invecchiamento accelerato con lampada UV	ASTM G 145-16	Tempo di esposizione 500 ore	Valutazione scala di grigi: 4/5 lieve variazione di lucentezza superficiale e lieve variazione di colore

COMPOSITION

Type of composition, application and installation to be defined based on specific project requirements.

The information you need to provide for the development of the projects are:

- Reference and contact details of the project manager
- Intended use of the project space (residential / public)
- Type of environment and particular weather conditions (indoor, outdoor, sea front, etc.)
- Description of the current state of the project space and wall composition (concrete, wood, plasterboard)
- Drawings with dimensions (DWG, PDF or 3D)
- De Castelli materials and finishes choices accompanied by the corresponding code (see the abacus finishes at the end of the catalog or on the website at the link <https://www.decastelli.com/en/materials/>)
- Estimated date of project completion
- Bracket color indication to be chosen between RAL 9010 or RAL 9005

Brackets modules
Moduli di staffe

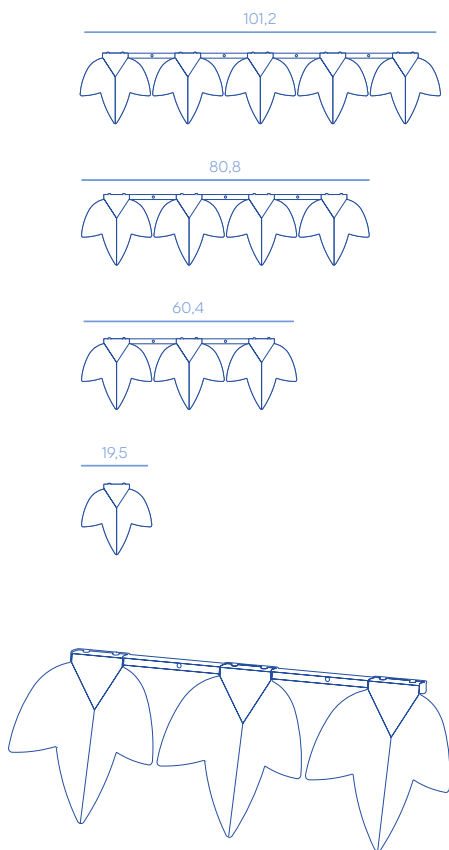

COMPOSIZIONE

Tipologia di composizione, applicazione ed installazione da definire a progetto.

Ai fini della definizione del progetto sono richieste le seguenti informazioni:

- Riferimenti e recapiti del responsabile di progetto
- Destinazione d'uso dello spazio di progetto (residenziale/pubblico)
- Tipologia di ambiente e condizioni metereologiche particolari (interno, esterno, fronte mare, ecc)
- Descrizione dello stato di fatto e composizione muraria (cemento, legno, cartongesso)
- Disegni quotati (DWG, PDF o 3D)
- Indicazione di materiali e finiture De Castelli corredate da codice corrispondente (si veda abaco finiture a fine catalogo o sul sito al link <https://www.decastelli.com/materiali/>)
- Data prevista per il completamento del progetto
- Indicazione colore staffe a scelta fra RAL 9010 o RAL 9005



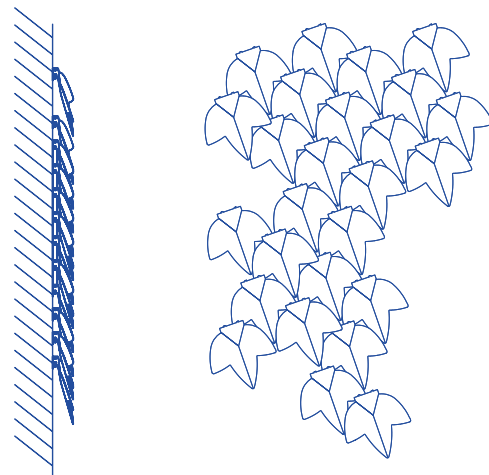

Composition example
Composizione tipo

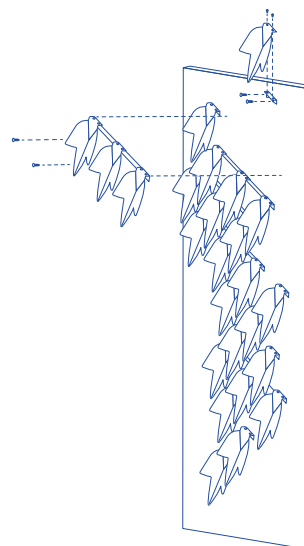

Fixing system
Sistema di fissaggio



VERTICAL GREEN

-  As per project
-  Min 60 mm
-  40 pz/m²
-  Wall
-  Indoor, Outdoor

 RAL 9010 or 9005 lacquered brackets to be specified at order confirmation.
Staffe laccate RAL 9010 o 9005 da specificare alla conferma dell'ordine.



F2

**BRASS
OTTONE**

CODE / CODICE	IN	OUT	METAL FINISHES			MINIMUM ORDER/ORDINE MINIMO	EURO	
DS700-F2	•		x40	Brass Ottone	DeLabré DeLabré	F2	1 m ²	2.300,00 Per m ² Al m ²

 10 Kg/m²

Excluding VAT
IVA esclusa

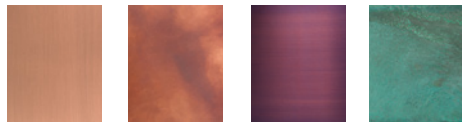

F5

G5

G11

F7

**COPPER
RAME**

CODE / CODICE	IN	OUT	METAL FINISHES			MINIMUM ORDER/ORDINE MINIMO	EURO	
DS700-F5	•		x40	Copper Rame	Satin Satinato	F5	1 m ²	2.300,00 Per m ² Al m ²
DS700-G5	•		x40	Copper Rame	DeLabré DeLabré	G5	1 m ²	2.300,00 Per m ² Al m ²
DS700-G11	•		x40	Copper Rame	Rubin Rubino	G11	1 m ²	2.300,00 Per m ² Al m ²
DS700-F7	•		x40	Copper Rame	Verdigris Verderame	F7	1 m ²	2.300,00 Per m ² Al m ²

 10 Kg/m²

Excluding VAT
IVA esclusa

VERTICAL GREEN

 On design

 Min 60 mm

 40 pz/m²

 Wall

 Indoor, Outdoor

 RAL 9010 or 9005 lacquered brackets to be specified at order confirmation.
Staffe laccate RAL 9010 o 9005 da specificare alla conferma dell'ordine.

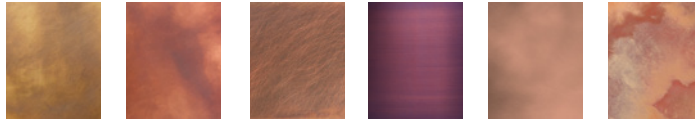

F2 G5 G4 G11 M10 M2

COPPER RAME

CODE / CODICE	IN	OUT	METAL FINISHES				MINIMUM ORDER/ORDINE MINIMO	EURO
DS700-MIX	•		x10	Brass Ottone	DeLabré DeLabré	F2	1 m ²	2.850,00 Per m ² Al m ²
			x5	Copper Rame	Satin Satinato	F5		
			x10	Copper Rame	DeLabré DeLabré	G5		
			x5	Copper Rame	Rubin Rubino	G11		
			x10	Copper Rame	Verdigris Verderame	F7		

 10 Kg/m²

Excluding VAT
IVA esclusa

Materioteca

Brass Ottone

- F1 Satin brass
Ottone satinato
- M9 Brushed brass
Ottone spazzolato
- E13 Polished brass
Ottone lucido
- F2 DeLabré brass
Ottone DeLabré
- G3 Orbitale DeLabré brass
Ottone DeLabré orbitale
- G7 Striped DeLabré brass
Ottone DeLabré striato
- M7 DeSalt brass
Ottone DeSalt
- M3 DeOpale brass
Ottone DeOpale
- M6 DeMarea brass
Ottone DeMarea
- M16 DeSatén brass
Ottone DeSatén
- G8 Hammered polished brass
Ottone martellato lucido
- F3 Bronzed DeMastral brass
Ottone DeMastral brunito
- H- DeErosion on brass
DeErosion su ottone
- L- DeGlyphé brass
Ottone DeGlyphé



F1 M9 E13 F2 G3

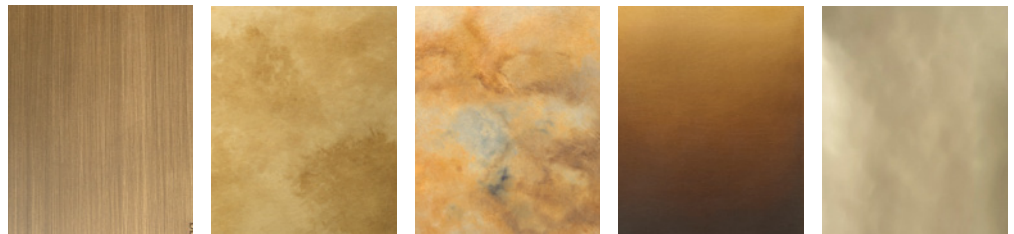

G7 M7 M3 M6 M16

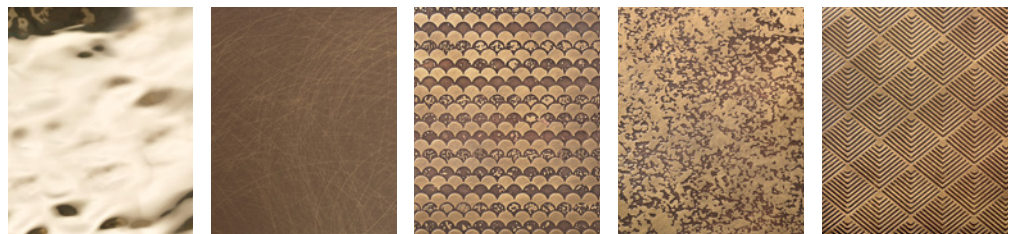

G8 F3 H2 H3 H4
H4M

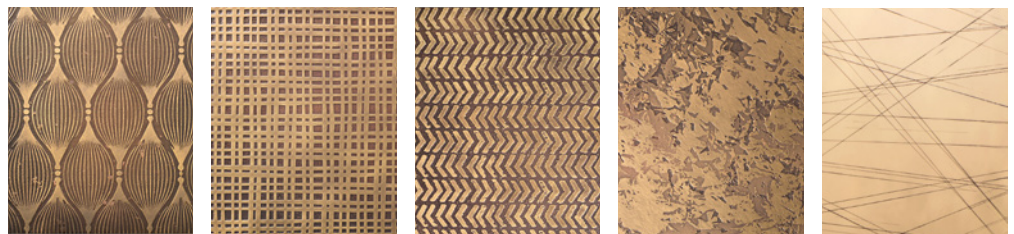

H5 H6
H6M H7
H7M H8 H10

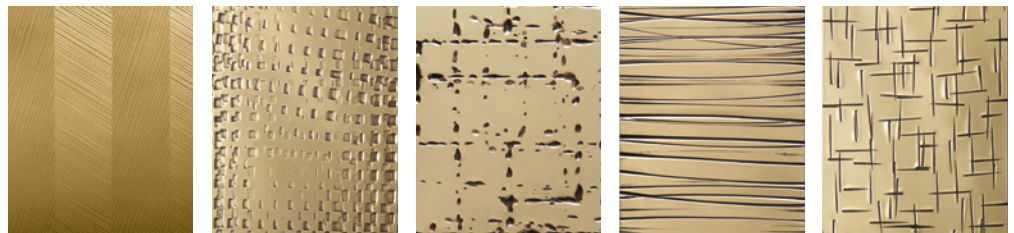



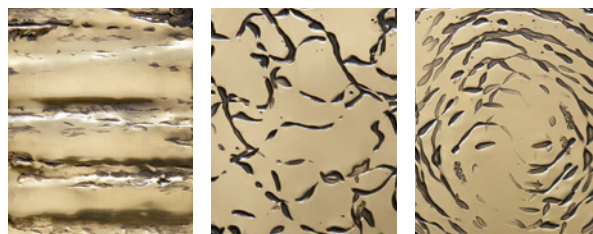





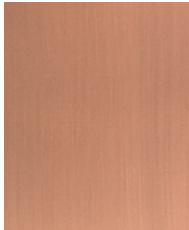
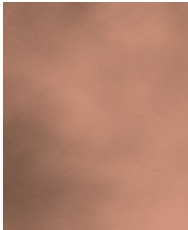
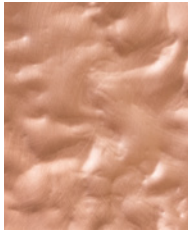



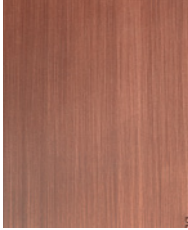

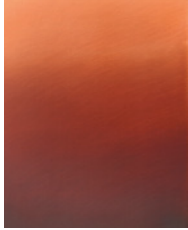
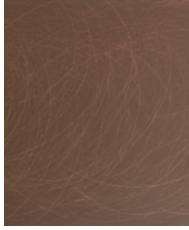
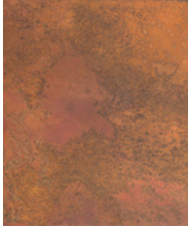
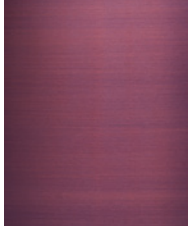
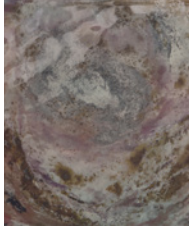
H12 L1 L2 L3 L4

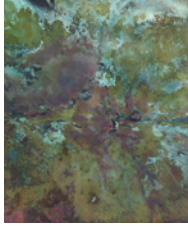
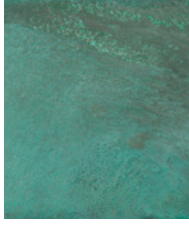
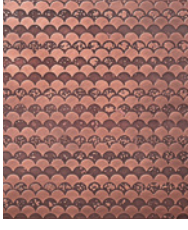
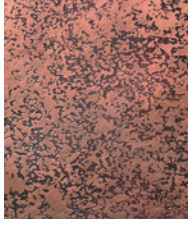
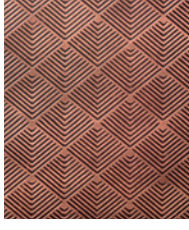
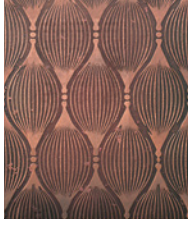
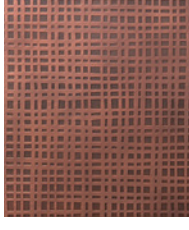
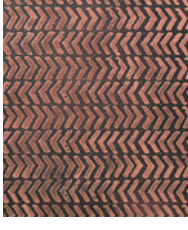
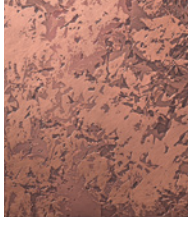

L5 L6 L7

Copper Rame

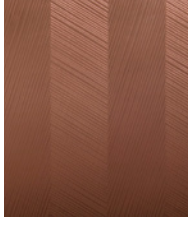
F5	Satin copper Rame satinato					
F5		F5	M10	G10	E14	G5
M10	Brushed copper Rame spazzolato					
G10	Brushed hammered copper Rame martellato spazzolato					
E14	Polished copper Rame lucido					
G5	DeLabré copper Rame DeLabré					
G4	Orbitale DeLabré copper Rame DeLabré orbitale	G4	G6	M2	M17	M5
G6	Striped DeLabré copper Rame DeLabré striato					
M2	DeOpale copper Rame DeOpale					
M17	DeSatén copper Rame DeSatén					
M5	DeMarea copper Rame DeMarea					
F8	Bronzed DeMaistral copper Rame DeMaistral brunito	F8	F6	G11	N1	N10
F6	Mottled copper Rame fiammato					
G11	Ruby copper Rame rubino					
N1	Forest DeNuance copper DeNuance foresta rame					
N10	Forest matt DeNuance copper DeNuance foresta opaco rame					
N2	Ocean DeNuance copper DeNuance oceano rame	N2	N20	N30	N4	N40
N20	Ocean matt DeNuance copper DeNuance oceano opaco rame					
N30	Verdigris DeNuance copper DeNuance verderame rame					
N4	Lagoon DeNuance copper DeNuance laguna rame					
N40	Lagoon matt DeNuance copper DeNuance laguna opaco rame					
F7	Verdigris copper Verderame rame	F7	H2	H3	H4 H4M	H5
H -	DeErosion on copper DeErosion su rame					
H6						
H6M			H7 H7M	H8	H10	H12

Stainless steel

Acciaio inox

- D1 Satin stainless steel
Acciaio inox satinato
- M11 Brushed stainless steel
Acciaio inox spazzolato
- D2 Polished stainless steel
Acciaio inox lucido
- G12 DeDeep stainless steel
Acciaio inox DeDeep
- M0 DeOpale stainless steel
Acciaio inox DeOpale
- E11 DeLabré stainless steel
Acciaio inox DeLabré
- G2 Orbitale DeLabré stainless steel
Acciaio inox DeLabré orbitale
- E6 Striped DeLabré stainless steel
Acciaio inox DeLabré striato
- M4 DeMarea stainless steel
Acciaio inox DeMarea
- E5 DeLabré B stainless steel
Acciaio inox DeLabré B
- E7 DeDarié stainless steel
Acciaio inox DeDarié
- E8 Noir Sablé
- E9 Maron Sablé
- D3 Bronzed DeMastral stainless steel
Acciaio inox DeMastral brunito
- D6/
D7 Corten
- M14 Polished brass finishing
Finitura ottone lucido
- M13 Polished copper finishing
Finitura rame lucido
- D8 Ral 9010
- H - DeErosion on stainless steel
DeErosion su acciaio inox



D1 M11 D2 G12

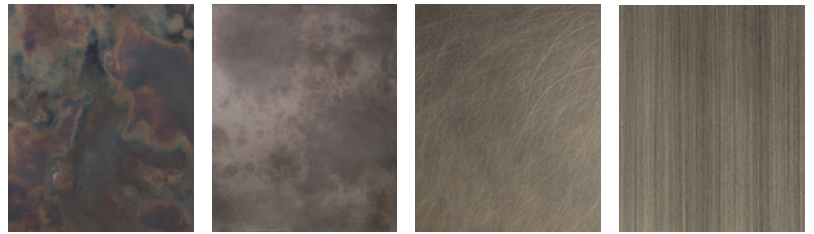

M0 E11 G2 E6



M4 E5 E7 E8



E9 D3 D6 / D7 M14

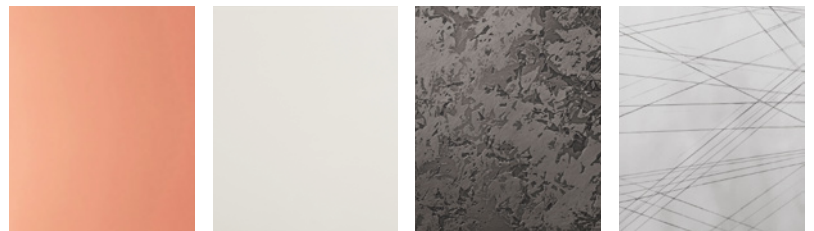

M13 D8 H8 H10

Sales conditions

Termini e condizioni di vendita

01. ORDER

Following receipt of the Order, De Castelli S.r.l. (hereinafter "**De Castelli**") will send its offer (hereinafter "**Offer**") in writing to the buyer (hereinafter "**Buyer**"), of which these general terms and conditions of sale (hereinafter "**General Terms**") are an integral part. It is understood that the Order shall be deemed confirmed with consequent completion of the contract (hereinafter "**Contract**"), only upon receipt by De Castelli of the Offer signed for acknowledgement and acceptance by the Buyer and, at the same time, the payment by the Buyer of the deposit indicated in the Offer. It is also understood that De Castelli has the right not to process a confirmed Order, without incurring any liability, should the Buyer become insolvent and/or suspend all or part of its business activities. It is further understood that:

(i) any cancellation or modification of the Order communicated in writing from the Buyer to De Castelli after the completion of the Contract, but prior to the production of the Order, as well as any modification of the Order communicated in writing by the Buyer to De Castelli after the completion of the Contract and the production of the Order shall not take effect unless prior authorisation or subsequent acceptance in writing has been given by De Castelli, which reserves the right to modify the amount indicated in the Offer. If the Buyer communicates in writing, following De Castelli's non-acceptance or authorisation, that it has no interest in receiving the Order whose cancellation or unmodified Order it has requested, the Contract shall be considered terminated and De Castelli reserves the right to withhold any amounts already paid by the Buyer and, if the Order has already been put into production, to request the balance of the Order, without prejudice, in both cases, to compensation for further damages. The same provision applies should the Buyer communicate in writing not to accept any modification of the amount by De Castelli.

(ii) in case of cancellation of the Order communicated in writing by the Buyer after the completion of the Contract and the production of the Order, the Contract shall be considered terminated and De Castelli reserves the right to withhold any amounts received from the Buyer as a deposit, as well as to request the balance of the Order, without prejudice to compensation for further damages.

02. PRICES

This price list cancels and replaces all previous price lists, unless otherwise provided for in the Offer. The prices are VAT excluded by law to the public and are expressed in Euros.

03. PAYMENTS

The amounts due from the Buyer to De Castelli, as well as the terms and conditions of payment are indicated in the Offer. In case of delay in paying any amount due to De Castelli, interest and commissions will be charged as provided for by current legislation, without prejudice to compensation for further damages. It is also understood that: (i) unless otherwise provided for in the Offer, the payment of the full amount due from the Buyer in relation to the Order is an essential condition for the ordered products to be delivered; (ii) in the event of termination of the Contract due to non-fulfilment of contract by the Buyer, De Castelli reserves the right to withhold any amounts already paid by the Buyer, without prejudice to compensation for further damages.

04. PRODUCTS

Since it is not possible to guarantee a printed reproduction that is completely faithful to the original, images of the finishes and materials where present are to be considered purely indicative and do not replace the samples in vision. All De Castelli finishes are made by manual and artisan processes. Any differences compared to the sample in vision do not constitute a defect, but a characteristic of manual processing that is susceptible to variations in tonality and homogeneity.

05. DELIVERY TERMS

The delivery terms will be indicated in the Offer. These terms are not binding and are subject to the possibility of production and shipping by De Castelli, it being understood that, in case of delay in delivery, no liability can be attributed to De Castelli and, consequently, the Buyer cannot make any claim and/or request for damages to De Castelli, nor terminate the Contract.

01. ORDINI

A seguito del ricevimento dell'Ordine, De Castelli S.r.l. (di seguito "**De Castelli**") invierà per iscritto all'acquirente (di seguito "**Acquirente**") la propria offerta ("**Offerta**"), di cui le presenti condizioni generali di vendita (di seguito "**Condizioni Generali**") sono parte integrante. Resta inteso che l'Ordine si intende confermato, con conseguente perfezionamento del contratto (di seguito "**Contratto**"), soltanto con il ricevimento da parte di De Castelli dell'Offerta sottoscritta per conoscenza e accettazione dall'Acquirente e, contestualmente, del pagamento da parte dell'Acquirente dell'acconto indicato in Offerta. Resta, inoltre, inteso che De Castelli ha la facoltà di non dar corso ad un Ordine confermato, senza incorrere in alcuna responsabilità, qualora l'Acquirente diventi insolvente e/o sospenda in tutto o in parte le proprie attività commerciali. Resta, altresì, inteso che:

(i) l'eventuale annullamento o le eventuali modifiche dell'Ordine comunicati per iscritto dall'Acquirente a De Castelli successivamente al perfezionamento del Contratto, ma prima della messa in produzione dell'Ordine, nonché le eventuali modifiche dell'Ordine comunicate per iscritto dall'Acquirente a De Castelli successivamente al perfezionamento del Contratto e alla messa in produzione dell'Ordine non avranno effetto salvo previa autorizzazione o successiva accettazione, per iscritto, di De Castelli, la quale si riserva il diritto di modificare l'importo indicato in Offerta. Qualora a seguito della mancata accettazione o autorizzazione di De Castelli, l'Acquirente comunichi per iscritto di non aver interesse a ricevere l'Ordine di cui ha chiesto l'annullamento o l'Ordine non modificato, il Contratto si intenderà risolto e De Castelli si riserva il diritto di trattenere le eventuali somme già versate dall'Acquirente e, nel caso sia già stato messo in produzione l'Ordine, di richiedere anche il saldo dell'Ordine, fatto salvo, in entrambi i casi, il risarcimento del maggior danno. La medesima previsione si applica qualora l'Acquirente dovesse comunicare per iscritto di non accettare l'eventuale modifica dell'importo da parte di De Castelli;

(ii) in caso di annullamento dell'Ordine comunicato per iscritto dall'Acquirente successivamente al perfezionamento del Contratto e alla messa in produzione dell'Ordine, il Contratto si intenderà risolto e De Castelli si riserva il diritto di trattenere eventuali somme ricevute dall'Acquirente a titolo di acconto, nonché di richiedere il saldo dell'Ordine, fatto salvo il risarcimento del maggior danno.

02. PREZZI

Il presente listino annulla e sostituisce tutti i listini precedenti, salvo che non sia diversamente previsto in Offerta. I prezzi sono al pubblico, IVA a termini di legge esclusa e sono espressi in Euro.

03. PAGAMENTI

Gli importi dovuti dall'Acquirente a De Castelli, nonché i relativi termini e modalità di pagamento sono indicati in Offerta. In caso di ritardo nel pagamento di qualsiasi somma dovuta a De Castelli, saranno conteggiati interessi e commissioni come previsto dalla normativa vigente, fatto salvo il risarcimento del maggior danno. Resta, inoltre, inteso che: (i) salvo che non sia diversamente previsto in Offerta, il pagamento dell'intero importo dovuto dall'Acquirente in relazione all'Ordine è condizione essenziale per l'effettuazione della consegna dei prodotti ordinati; (ii) in caso di risoluzione del Contratto per inadempimento dell'Acquirente, De Castelli si riserva il diritto di trattenere le eventuali somme già versate dall'Acquirente, fatto salvo il risarcimento del maggior danno.

04. PRODOTTI

Le immagini delle finiture e dei materiali laddove presenti sono da considerarsi puramente indicative, non essendo possibile garantire una riproduzione stampata che sia del tutto fedele all'originale e non sostituiscono i campioni in visione. Tutte le finiture De Castelli sono realizzate attraverso processi manuali ed artigianali. Differenze rispetto al campione in visione non costituiscono un difetto, bensì una caratteristica della lavorazione manuale che è suscettibile a variazioni di tonalità e omogeneità.

05. TERMINI DI CONSEGNA

I termini di consegna saranno indicati in Offerta. Tali termini non sono vincolanti e sono subordinati alle possibilità di produzione e di spedizione da parte di De Castelli, restando, quindi, inteso che, in caso di ritardo nella consegna, nessuna responsabilità potrà essere imputata a De Castelli e, conseguentemente, l'Acquirente non potrà avanzare alcuna pretesa e/o richiesta di risarcimento del danno nei confronti di De Castelli né risolvere il Contratto.

06. PROPERTY RIGHTS

All texts, photos, images, graphic design, colours, motifs, designs, models, products, and layout are protected by copyright and/or industrial property rights belonging to De Castelli and their reproduction is forbidden without De Castelli's prior written consent. De Castelli is also the owner of the trademark "De Castelli" and "C" (struck through) and of any other distinctive sign used and/or registered by the latter. The Buyer acknowledges that copyright and industrial property rights relating to texts, photos, images, graphic design, colours, motifs, designs, models, products, the layout and trademarks and any other distinctive sign used and/or registered remains with De Castelli and acknowledges that their reproduction, in whole or in part, is forbidden without De Castelli's prior written consent.

07. TRANSPORT COSTS

Delivery is Ex-works at De Castelli's premises, unless otherwise specified in the Offer.

08. COMPLAINTS

Any complaint related to the products must be made in writing by the Buyer, under penalty of forfeiture, within 8 (eight) days of receiving the products. Furthermore, it is understood that De Castelli shall be liable exclusively for product defects, which De Castelli, after appropriate checks, should ascertain to be actually attributable to De Castelli. Any return and/or replacement of the products must be previously authorised in writing by De Castelli and, in case of authorisation, the products must be returned in their original cageaging and in perfect condition. Unauthorised returns will be sent back to the Buyer and the relative transport costs will be charged to the Buyer. Without prejudice to the foregoing, if the return does not take place Ex-works, the Buyer must check the weight, the quantity of the products, as well as the number of cageages and the state of the cageaging prior to collection, and make the necessary reservations to the carrier in writing on the waybill, it being understood that if this is not the case, the relative complaints will not be accepted by De Castelli and any damages will be fully borne by the Buyer. It is also understood that any complaint, sent by the Buyer pursuant to this article, will not be accepted if made after the installation of the products.

09. MODIFICATIONS

De Castelli reserves the right to make any changes or modifications that are deemed necessary to improve the technical characteristics or commercial needs of its products without prior notice.

10. LEGAL NOTES

All rights to the contents of this price list are reserved to De Castelli pursuant to current legislation. Any reproduction, disclosure and/or distribution, in whole or in part, of the contents of this price list is strictly forbidden without the prior written authorisation of De Castelli.

11. APPLICABLE LAW AND JURISDICTION

Italian law is applied to the General Terms and to the Contract. Any dispute related to the General Terms and/or to the Contract shall be subject to the exclusive jurisdiction of the Court of Milan.

06. DIRITTI DI PROPRIETÀ

Sono protetti dal diritto d'autore e/o dal diritto di proprietà industriale in capo a De Castelli tutti i testi, le foto, le immagini, la grafica, i colori, i motivi, i disegni, i modelli, i prodotti e il layout e ne è vietata la riproduzione, senza il preventivo consenso scritto di De Castelli. De Castelli è altresì titolare del marchio "De Castelli" e "C" (barrato) e di ogni altro segno distintivo utilizzato e/o registrato dallo stesso. L'Acquirente riconosce che il diritto d'autore e la proprietà industriale relativa ai testi, le foto, le immagini, la grafica, i colori, i motivi, i disegni, i modelli, i prodotti, il layout e i marchi e di ogni altro segno distintivo utilizzato e/o registrato resta in capo a De Castelli e riconosce che ne è vietata la riproduzione, totale o parziale, senza il preventivo consenso scritto di De Castelli.

07. SPESE DI TRASPORTO

La resa avviene Ex-works presso la sede di De Castelli, salvo diversamente specificato in Offerta.

08. RECLAMI

Qualsiasi reclamo relativo ai prodotti dovrà essere effettuato per iscritto dall'Acquirente, a pena di decadenza, entro 8 (otto) giorni dal ricevimento dei prodotti. Resta, inoltre, inteso che De Castelli risponderà esclusivamente per difetti dei prodotti, che De Castelli, a seguito delle opportune verifiche, dovesse accertare essere alla stessa effettivamente imputabili. Eventuali resi e/o sostituzioni dei prodotti dovranno essere preventivamente autorizzati in forma scritta da De Castelli e, in caso di autorizzazione, i prodotti dovranno essere resi in perfette condizioni e negli imballaggi originali, che dovranno anch'essi essere in perfette condizioni. I resi non autorizzati saranno rispediti all'Acquirente e le relative spese di trasporto saranno addebitate allo stesso. Fermo restando quanto precede, nel caso in cui la resa non avvenga Ex-works, l'Acquirente dovrà verificare il peso, le quantità dei prodotti, nonché il numero di colli e lo stato dell'imballaggio prima del ritiro e fare le dovute riserve al vettore in forma scritta sulla lettera di vettura, restando inteso che, in caso contrario, i relativi reclami non saranno accettati da De Castelli e gli eventuali danni saranno completamente a carico dell'Acquirente. Resta, inoltre, inteso che qualsiasi reclamo, inviato dall'Acquirente ai sensi del presente articolo, non sarà accettato se effettuato dopo la posa in opera dei prodotti.

09. MODIFICHE

De Castelli si riserva di apportare ai propri prodotti, senza alcun preavviso, eventuali cambiamenti o modifiche ritenute necessarie per il miglioramento delle caratteristiche tecniche o per esigenze commerciali.

10. NOTE LEGALI

Ogni diritto sui contenuti presenti in questo listino è riservato a De Castelli ai sensi della normativa vigente. È espressamente vietata qualsiasi riproduzione, divulgazione e/o distribuzione, totale o parziale, del contenuto di questo listino, in assenza della previa autorizzazione scritta di De Castelli.

11. LEGGE APPLICABILE E FORO COMPETENTE

Alle Condizioni Generali e al Contratto si applica la legge italiana. Per qualunque controversia relativa alle Condizioni Generali e/o al Contratto sarà competente, in via esclusiva, il Foro di Milano.

De Castelli Srl – Headquarters
Via delle Industrie, 10
31035 Crocetta del Montello TV, Italy
+39 0423 638218

De Castelli Gallery – Milan
Via Uberto Visconti di Modrone, 20
20122 Milan MI, Italy
+39 02 76006999

info@decastelli.com
decastelli.com

