

Metal Affinities

A poetic fusion between space and matter, a fluid manifestation of metal. An encounter that generates visual and tactile affinities, a sensory harmony. An ode to the expressive balance between form and design.

Fusione poetica tra spazio e materia, manifestazione fluida del metallo. Un incontro che genera affinità visive e tattili, un'armonia sensoriale. Un'ode all'equilibrio espressivo tra forma e progetto.

Metal Affinities is an invitation to explore the world of design through the distinctive lens of De Castelli. The catalogue narrates stories of innovation and creativity, where deep dialogues between objects, surfaces, and architecture are heard. Metal expresses itself in a fluid manifestation of its essence: a universal material that shapes space, integrating seamlessly in perfect harmony. These affinities, surpassing the very surface of perception, fade into the unsaid: a whispered invitation to discover the most intimate connections of beauty.

Metal Affinities è un invito a esplorare il mondo del design attraverso la lente distintiva di De Castelli. Il catalogo narra storie di innovazione e creatività, in cui si ascoltano dialoghi profondi tra oggetti, superfici e architettura. Il metallo si esprime in una manifestazione fluida della sua essenza: una materia universale che plasma lo spazio integrandosi in perfetta armonia. Queste affinità, che superano la superficie stessa della percezione, sfumano nel non detto: un invito sussurrato a scoprire le connessioni più intime della bellezza.

Cabinets & Sideboards

- 6 Canneto
- 12 Celato
- 22 Elizabeth
- 28 Graffio
- 32 Longing Cabinet
- 34 Marea
- 42 Mida
- 44 Pandora
- 50 Polifemo
- 52 Ripple
- 56 Sculpt
- 60 Tako
- 66 Xilo
- 70 Yoroi

Bookcases

- 76 Airframe
- 80 Babele
- 84 Existence
- 88 Nami
- 92 Nippon
- 94 Talea

Consoles

- 98 Convivium
- 100 Existence
- 102 Folio
- 104 Sinestesia

Tables

- 108 Baia
- 112 Burraco
- 114 Convivium
- 118 Coste
- 122 Folio
- 128 Plateaux of Mirror
- 132 Roma
- 136 Vela

Seatings

- 140 Caravan
- 142 Loom
- 144 Ori
- 146 Efesto
- 148 Pensando ad Acapulco
- 152 Via Veneto
- 154 Wave

Coffee tables

- 156 Alchemy
- 160 Alpha
- 164 Band
- 166 Between Nature
- 168 Botero
- 172 Drops

- 176 Flocks
- 180 Nicola
- 182 Parsec
- 184 Placas
- 188 Scribble
- 192 Sunrise & Sunset
- 196 Syro
- 198 Syro XL
- 200 Xilo

Dividers

- 202 Monolite
- 204 Painting

Lightings

- 206 Aare
- 212 Foliage
- 214 Light&Shade
- 220 Luce Solida
- 224 Ribot
- 226 Twist

Mirrors

- 230 Brame
- 232 Frame
- 236 Riflesso
- 238 Syro

Frames

- 240 Arazzi
- 242 Erosion
- 243 Hexagon
- 244 Poyagi
- 245 Solar
- 246 Wild Geometries
- 247 Yoko

Pots

- 250 A-Modulo
- 251 Cohiba
- 252 Conique
- 253 Cube
- 254 Dafne & Demetra
- 256 Delta & Omega
- 257 Narnya
- 258 Phil
- 259 Riviera Pots
- 260 Rocco & Lolita
- 261 Screen-Pot
- 262 Shimla & Jaipur
- 263 Tristan & Isotte

Landscape

- 264 Cottage N.1
- 265 Dog House N.1
- 265 Nest House N.1

Furniture



DATA SHEET P.355

DESIGN BY ADRIANO DESIGN

The Canneto Collection consists of sculptural volumes defined by a fluting composed of vertical rods of different diameters in brushed metal, creating irregular undulations and a fascinating interplay of reflections. The metal top is set slightly lower than the perimeter of the pieces, thereby highlighting the frame in black walnut, a precious wood that has also been used to create haute sophistication. The collection that started with the Barista mobile bar, internally clad in polished stainless steel, expands with a cabinet and a console, in a floor version and a suspended one.

La collezione Canneto è caratterizzata da oggetti dai volumi scultorei definiti da un canneté di tondini in metallo spazzolato, di diversi diametri, che creano una texture irregolare e danno vita a un intrigante gioco di luci. Il top superiore in metallo è in posizione leggermente ribassata rispetto al perimetro dei mobili ed evidenzia così la cornice in noce canaletto, prezioso materiale che, utilizzato per tutti gli interni, crea una proposta di grande eleganza e raffinatezza. La famiglia nata con il mobile bar Barista, internamente rivestito in acciaio inox a specchio, si amplia di cabinet e consolle, in versione sospesa e da terra.

← ↑
Canneto Barista DC668
Brushed copper M10

CABINETS & SIDEBOARDS



Canneto 234 wall-mounted Console dc673
Brushed copper M10



Canneto Cabinet dc674
Brushed brass M9



Canneté Wall cladding P.336
DS715-G2

Caravan Armchair P.140
DC657-M11-AQ

Erosion Frame P.242
DA105

Xilo Coffee table P.200
DC697-L2

Canneto Cabinet
DC674-M9





Celato



DATA SHEET P.356

←
Celato 160 Chest of drawers DC343
Orbitale DeLabré brass G3

↑
Celato 130 Chest of drawers DC346
DeLabré brass F2

Celato 80 Chest of drawers DC345
DeLabré brass F2

CABINETS & SIDEBOARDS

DESIGN BY R&D DE CASTELLI

Celato is a reference to what is concealed to keep a memory intact; it's an archetype in which beauty is revealed in stages. A monolithic appearance makes Celato a contemporary menhir; like a legend that tells of magnificent treasures safeguarded below sacred stones, Celato reveals its dual soul, with many internal, hidden, almost secret spaces. It combines several tesserae to form a whole: aesthetics, function and an incredible ability to make each piece unique, never identical to the others, revealed without impudence, walking an avant-garde line between tradition and modernity.

Celato è un richiamo a ciò che viene nascosto per mantenere integra la memoria, è un archetipo in cui la bellezza viene svelata per gradi. L'apparenza monolitica rende il Celato un contemporaneo menhir; come la leggenda che racconta di favolosi tesori custoditi sotto queste pietre sacre, il Celato rivela una doppia anima, con molti spazi interni, nascosti, quasi segreti. In esso si uniscono vari tasselli per comporre un insieme: estetica, funzionalità e grande abilità nel realizzare un oggetto unico, mai uguale a nessun altro, che si rivela senza sfrontatezza, all'avanguardia tra tradizione e modernità.

Celato 160 Chest of drawers DC343
Orbitale DeLabrè brass G3
DeLabrè B stainless steel E5
Striped DeLabrè copper G6

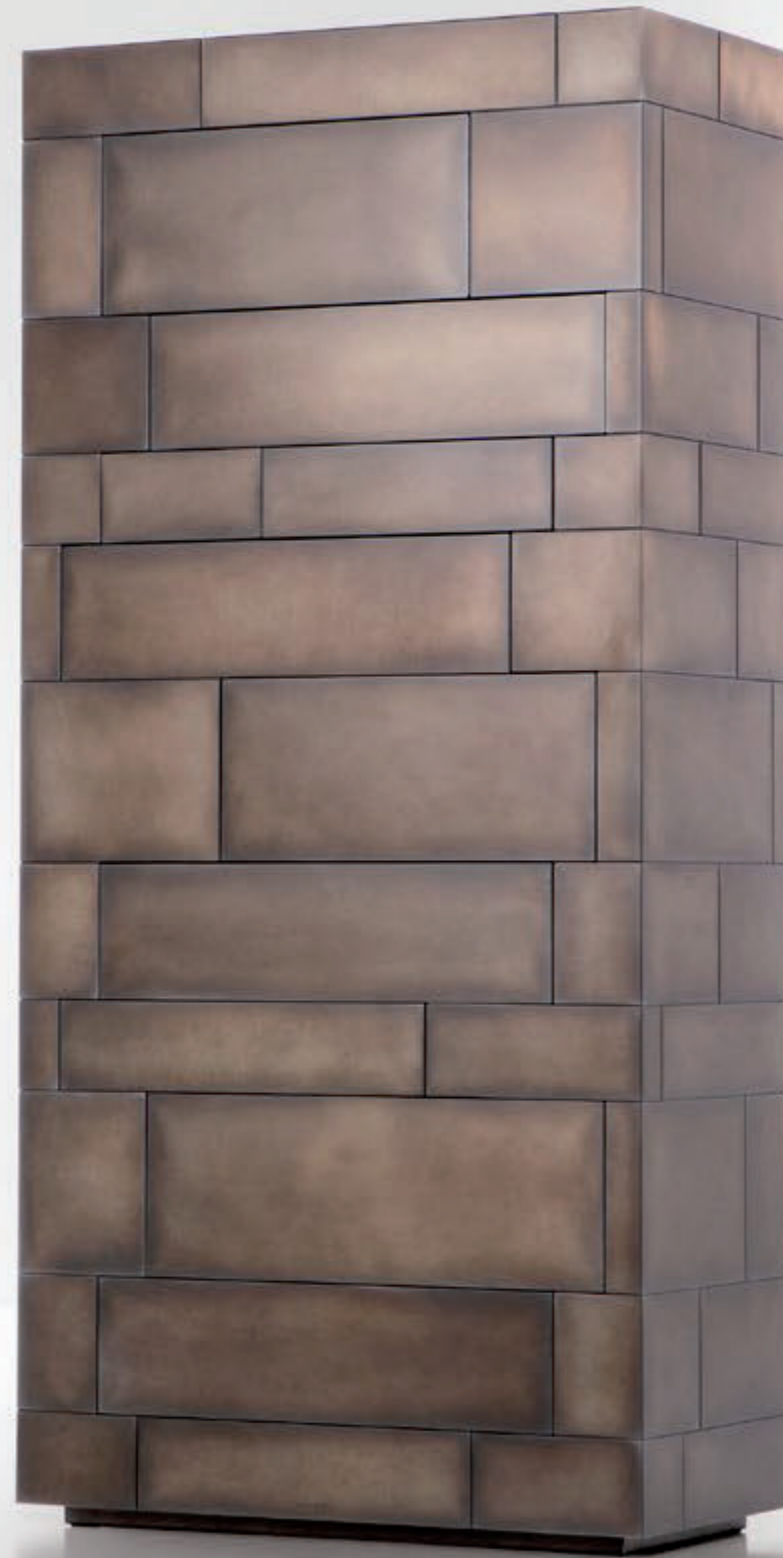

Celato 160 Cabinet
DC343-G6

Boiserie Cladding solution P.326
DeOpale stainless steel MO



↗
Celato 130 Sideboard
DC346-E6

Scribble Bracket Coffee table P. 188
DC549-G7



Celato 220 wall-mounted Console DC348
Orbitale DeLabré brass G3



Celato 45 Bedside table DC347
DeLabré B stainless steel E5
Orbitale DeLabré brass G3

Yoko O2 Frame P.248
DA101

Celato 220 floor Console
DC349-G4

Square 30 Mosaic P.302
DS707-C14





Elizabeth

DATA SHEET P.357

← ↗
Elizabeth Console DC541
Polished copper M13

CABINETS & SIDEBOARDS



DESIGN BY NATHALIE DEWEZ

Poised like a ballerina on her toes, Elizabeth gracefully unfurls her luminous dress as if it was a pleated fabric. Characteristic folds bring movement to the metal sheet that forms the surface of the cabinet, transforming every reflection into light. Juxtaposing lightness and tension, elasticity and rigidity, the metal vibrates to the rhythm of its folds. In stainless steel, brass and copper, and in console and cabinet versions, Elizabeth embodies a new vision of metal furnishing which is undeniably feminine.

Quasi fosse una ballerina sulle punte, Elizabeth dispiega con grazia il suo abito luminoso come un tessuto plissettato. La caratteristica piegatura del metallo conferisce movimento alla lastra che forma la superficie della madia, trasformando ogni riflesso in luce. In un gioco fra leggerezza e tensione, fra elasticità e rigore, il metallo vibra al ritmo delle sue pieghe. Declinata in acciaio, ottone e rame, Elizabeth - disponibile in versione console e madia - dà corpo a una nuova visione dell'arredo in metallo - di segno dichiaratamente femminile.



Elizabeth 180 Sideboard DC718
Polished brass M14



Elizabeth Console DC541
Polished stainless steel D2
Polished brass M14





Elizabeth Console
DC541-M13

Boiserie Wall Cladding p.326
Verdigris copper F7

Syro Mirrors p.238
DC620-G2 / DC619-G2 / DC618-G2

Elizabeth 180 Sideboard
DC718-M13





DATA SHEET P.357

DESIGN BY PAOLO BENEVELLI

Lines, engravings, wiry signs mark metal surfaces to tell about old stories. Scratching not only defines the use of an object, but it becomes a way of materially fixing the metaphors of life. Imperfections become memories, enhancing the pure essence of materials. The marks impressed on the cabinet doors are the preview of a story that has not been revealed yet.

Tracce, solchi, segni filiformi rigano la superficie del metallo raccontandone il passato attraverso il disegno di intrecci casuali: dalla suggestione del graffio, abituale indicatore di utilizzo intensivo di un oggetto, nasce l'idea di incidere nuove trame come metafora di vita vissuta. Le imperfezioni diventano memoria, esaltando l'essenza della materia. I segni depositati sulle ante della madia sono l'anticipazione di una storia ancora da condividere.

Graffio Cabinet DC639
 ← DeErosion on copper RA-H10
 ↗ DeErosion on brass OT-H10

Decorative panel
DeGlyphé beta L2

Folio Console P.102
DC699-M6

Syro Coffee tables P.196
DC512-G2 / DC511-G3

Graffio Cabinet
DC639-RA-H10



Longing Cabinet

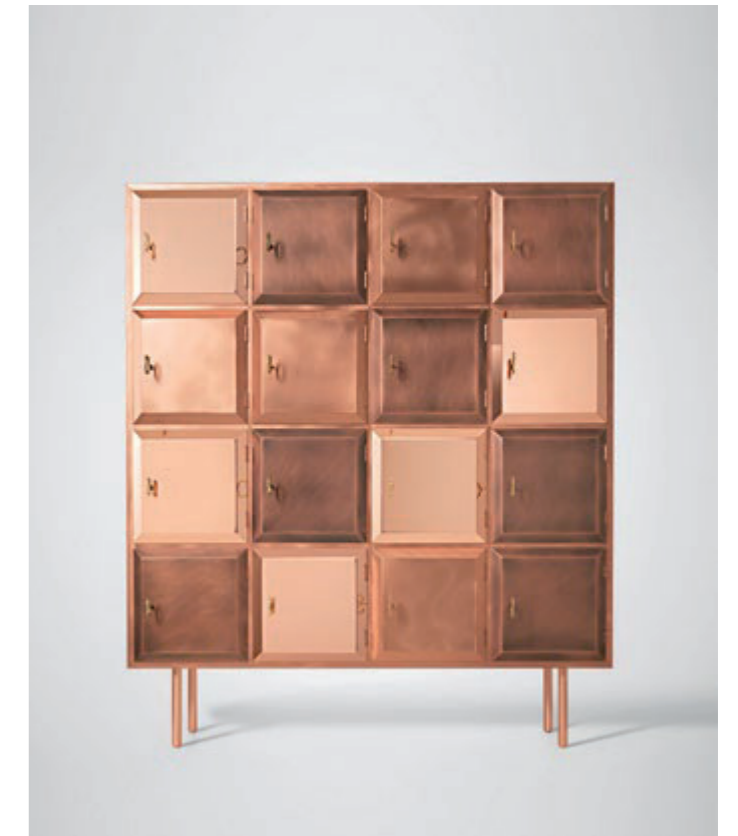

DATA SHEET P.358

DESIGN BY NIKA ZUPANK

Composed by small squared compartments, this cabinet of wishes makes a clear and current reference to old sideboards where biscuits and candies were usually kept away from children and locked up. A key for each compartment. An iconic piece of furniture. The cabinet expresses the peculiarities of wishes through the selection of De Castelli copper and brass finishes: for each compartment a unique finishing enhances the company know-how and its dedication to this precious material.

Il cabinet dei desideri. Un mobile dalla forma iconica e potente caratterizzata da piccoli scompartimenti, ognuno con la propria chiave, che tengono nascosti desideri e segreti. Il progetto è anche un riferimento contemporaneo alla credenza, un mobile largamente dimenticato e caratterizzato proprio da un lucchetto e una chiave che serviva a tenere biscotti e dolci fuori dalla portata dei bambini. La diversità di ogni desiderio che il cabinet esprime viene resa elegantemente dalle diverse finiture su rame e ottone che rappresentano l'essenza di De Castelli e la sua dedizione al materiale.

Longing Cabinet DC51
← Brass OT
↗ Copper RA

CABINETS & SIDEBOARDS

33

Marea



DATA SHEET P.358

Marea Cabinet dc605
← DeMarea stainless steel M4
← DeMarea brass M6
↗ DeMarea copper M5

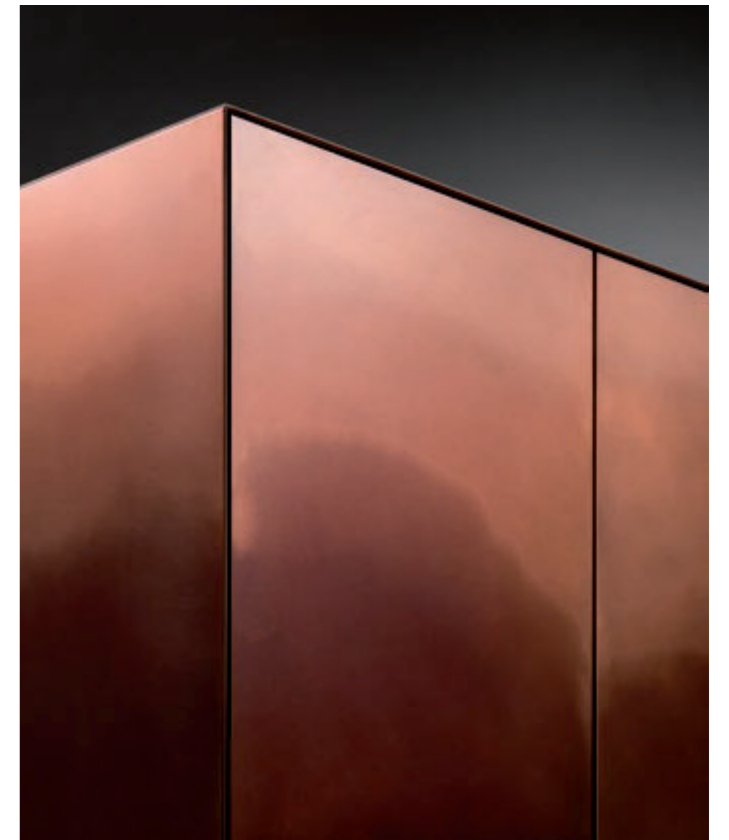

DESIGN BY ZANELLATO/BORTOTTO

Traces of time are drawn one on top of another, infused into the changing skin of the rigorous metal forms that define these cabinets and chests. Like the tide (marea in Italian) leaves its mark, wave after wave, even here the hand of the craftsman has left its sign, oxidation after oxidation, creating a painterly effect that resembles water erosion of the material. Somewhere between design object and work of art, each piece in the collection is unique thanks to an entirely hand-crafted finish that transforms the metal surface into a delicate watercolour.

Sulla pelle mutevole del metallo con cui sono composte le forme rigorose di questi mobili contenitori, si disegnano una sull'altra le tracce del tempo. Come la marea lascia il segno, onda dopo onda, anche qui la mano dell'artigiano ha lasciato la sua traccia, ossidazione dopo ossidazione, fino ad ottenere un effetto pittorico che somiglia all'erosione dell'acqua sul materiale. A metà tra oggetto di design e opera d'arte, ogni pezzo della collezione rappresenta un unicum grazie ad una finitura ottenuta completamente a mano che sembra trasformare la superficie metallica in delicato acquerello.

Marea 190 Sideboard DC606
DeMarea brass M6

Marea 113 Chest of Drawers DC607
DeMarea brass M6

Marea Cabinet DC605
DeMarea brass M6



Riflesso Mirrors P.236
DC608-450-G2 / DC608-700-G3

Marea 190 Sideboard
DC606-M6

Copycat Mosaic P.288
DS706-C1

Painting Divider P.204
DC540





Marea 50 Bedside table DC614
DeMarea stainless steel M4
DeMarea brass M6

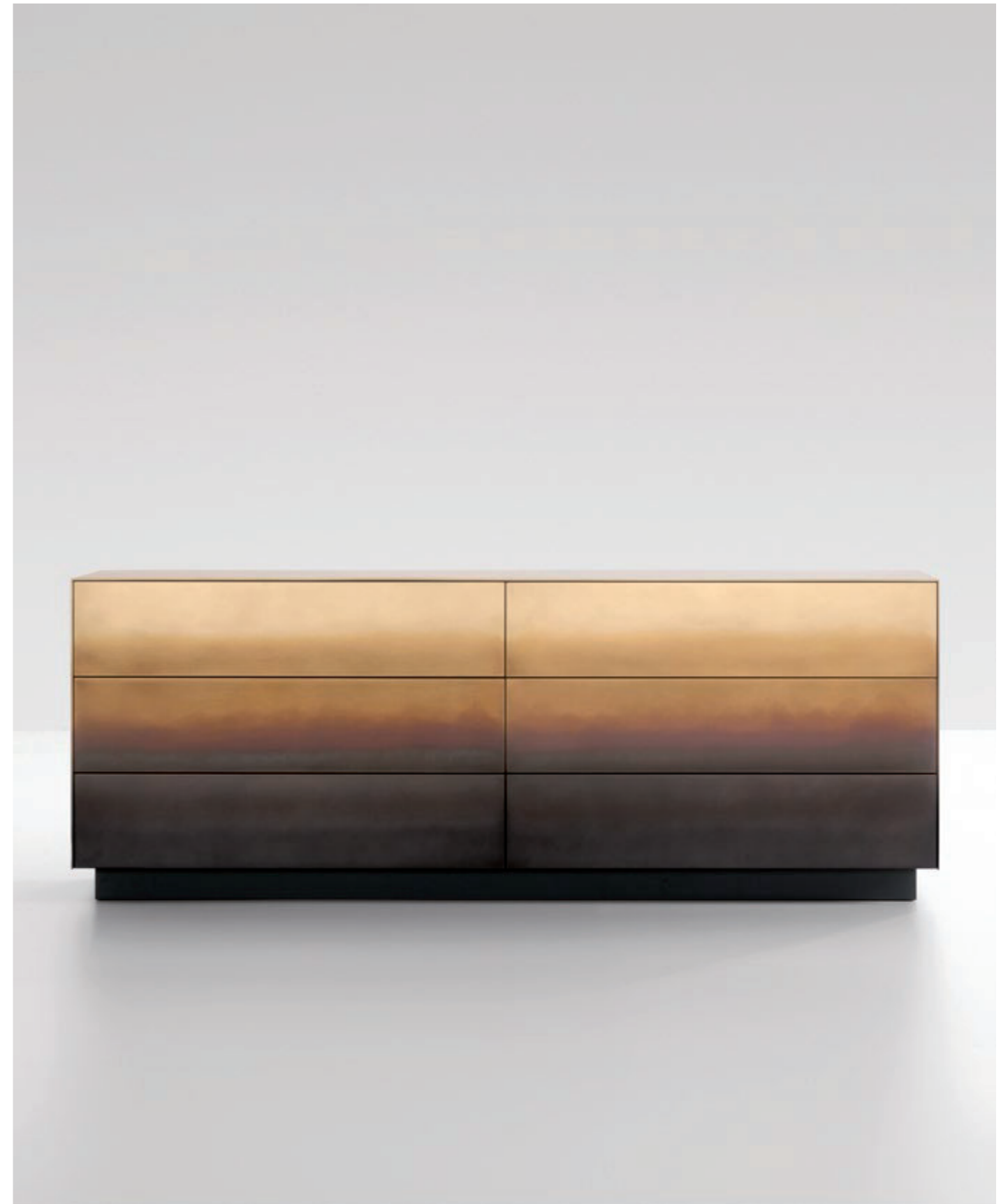

Marea 190 Dresser DC644
DeMarea brass M6



Mida



DATA SHEET P.359

DESIGN BY MARTINELLI VENEZIA

Defined by materials such as stainless steel, copper and brass, ennobled by De Castelli finishes, Mida is a perfect circle that conceals a cabinet, to collect, to contain, to organize and to hide objects at will. Wall-mounted like an abstract painting, it opens thanks to telescopic arms that slide the single door either right or left, becoming a celestial body that silently orbits in an imaginary eclipse.

Definito da materiali come acciaio, rame e ottone, nobilitato nelle finiture De Castelli, Mida è un cerchio perfetto che nasconde un cabinet dove raccogliere, contenere, ordinare, nascondere. Fissato a parete alla maniera di un quadro astratto, si apre grazie a guide telescopiche che permettono di far scivolare l'anta frontale a destra o a sinistra, quasi come un corpo celeste che scorre silenzioso secondo la propria orbita in un'immaginaria eclisse.

← ↑
Mida Cabinet DX dc602
DeOpale brass M3

Mida Cabinet SX dc601
DeOpale copper M2

Pandora



DATA SHEET P.359

DESIGN BY MARTINELLI VENEZIA

This drawer unit alludes to the archetypal shape of a vase. Like a modern treasure chest, Pandora was crafted to store - and thus 'hide' - all kinds of objects. In its different versions, from one to six drawers, this piece is versatile enough to be transformed, as you like, into a storage table, a bedside table or a full chest of drawers, used in varied spaces, from the bathroom to the bedroom or the living room. A mysterious, impressive object, Pandora surprises when the drawers, invisible when closed, are revealed.

È un mobile contenitore a cassetti che allude chiaramente alla forma archetipica del vaso. Come un moderno forziere, si presta a contenere e dunque a 'nascondere' qualunque cosa. Nelle diverse versioni da uno a sei cassetti, dimostra la sua versatilità trasformandosi di volta in volta in tavolino contenitore, comodino o cassetiera, giocando le proprie carte negli ambienti più vari, dal bagno alla camera, al living. Oggetto misterioso e stupefacente, sa sorprendere quando svela i cassetti che scompaiono totalmente alla vista quando chiusi.

←
Pandora 102 Chest of Drawers DC634-4M
Orbitale DeLabré brass G3

↗
Pandora Chest of Drawers DC634-2M/4M/6M
Orbitale DeLabré brass G3



Pandora 27 Bedside table DC634-1M
Orbitale DeLabré copper G4

Pandora 52 Bedside table DC634-2M
Orbitale DeLabré stainless steel G2

Pandora 52 Bedside Table
DC634-2M-G4

Canneté Cladding solution P.336
DS715-G2



Pandora Chest of Drawers
DC634-5M-G3 / DC634-2M-G3

Mida wall-mounted Cabinet P.42
DC602-M3

Copycat Mosaic P.288
DS706-C1



Polifemo



DATA SHEET P.360

Polifemo Cabinet dc550
← Brushed copper M10
↗ Brushed brass M9

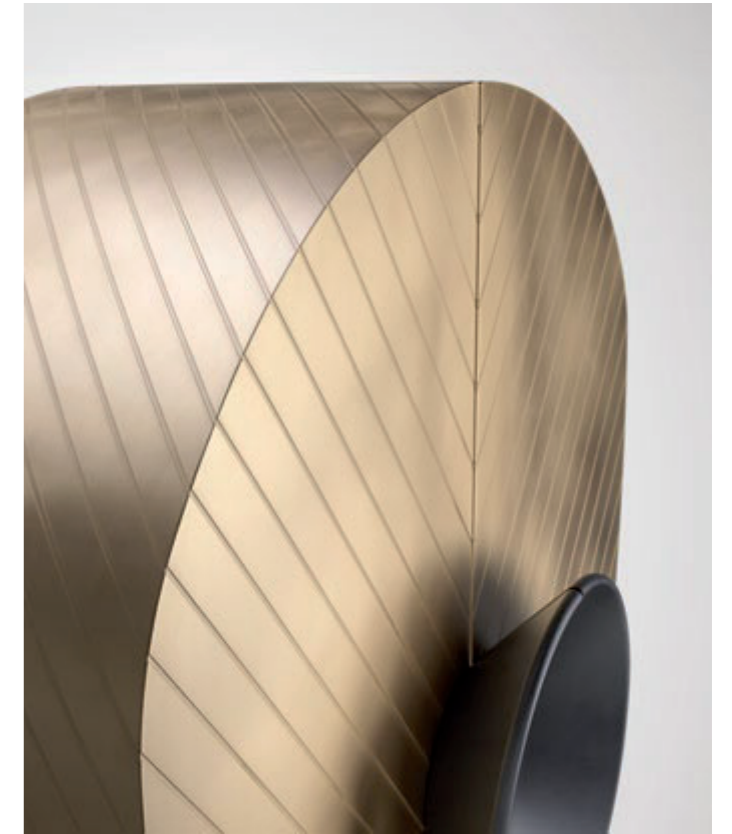

DESIGN BY ELENA SALMISTRARO

Balanced on slender legs, the legendary cyclops invades domestic spaces to reinvent home cabinetry. Its large eye becomes a handle and the robust body contrasts with the lightness of the legs in an eccentric visual imbalance. Without a doubt, it is a scenic container sure to get noticed: the solid wood structure is richly covered in a copper dress featuring ornamental incisions, which rhythmically mark its surface.

Il mitico ciclope, in equilibrio su esili gambe, invade lo spazio domestico e reinventa la madia di casa. Il suo grande occhio diviene maniglia e il corpo robusto si contrappone alla leggerezza delle gambe in un eccentrico sbilanciamento visivo. Di certo è un contenitore scenico che non passa inosservato: composto da una solida struttura lignea è riccamente vestito con abito di rame caratterizzato da incisioni ornamentali che ne ritmano la superficie.

Ripple



DATA SHEET P.360

← ↗
Ripple Cabinet DC696
Brushed brass M9



DESIGN BY MARCO PISATI

The Ripple cabinet is inspired by the fluidity of water and the texture of metal. The result is a sinuous volume in which soft lines generate reflections upon a metal surface shaped by the artisan processes of De Castelli. Like an object sculpted and polished by the slow, continuous undulating movement of water, Ripple is a sculpture to admire from all angles, walking around it. Though it appears impenetrable, the cabinet reveals two storage spaces within, like a treasure chest, hidden from sight thanks to the concave fronts which have been designed to open 180°.

Il cabinet Ripple è ispirato alla fluidità dell'acqua e alla matericità del metallo. Il risultato è un volume sinuoso e polimorfo, le cui linee morbide generano riflessi sulla superficie in metallo plasmato dalle lavorazioni artigianali di De Castelli. Come un oggetto scolpito e levigato dal lento e incessante movimento ondulatorio dell'acqua, Ripple è una scultura da ammirare nello spazio girandole attorno. Apparentemente impenetrabile, il cabinet è uno scrigno che svela al suo interno due spazi contenitivi, nascosti alla vista grazie alle ante concave, progettate per un'apertura a 180°.

Ripple Cabinet
DC696-M9

3D Wall Decorative P.310
DS704-F7/G12

Between Nature Coffee tables P.166
DC682-OT-ZEBR / DC683-OT-IMP

Light&Shade Lighting P.214
DC713-G12/M7





DATA SHEET P.360

DESIGN BY FRANCESCO FORCELLINI

Just as stone can be sculpted by an able stonecutter, hammering and rounding techniques can mould metal into supple, organic shapes. Sculpt is a cabinet characterised by understated aesthetics and three-dimensionality, which complete and enhance each other to highlight the processes and finishes applied to the metal. Bordered by crisp edges, the soft yet well-sculpted concavities of the doors mark the rhythmic pace of light and shadow as they play upon the surface, underscored by a surprising finish that gives the cabinet the elegance and sheen of silk.

Come la pietra si lascia smussare da un abile scalpello, così le tecniche di martellatura e bombatura plasmano il metallo per raggiungere deformazioni plastiche ed organiche. Sculpt è una media caratterizzata da un linguaggio formale essenziale e una matericità tridimensionale che si completano e valorizzano a vicenda per esaltare le lavorazioni e le finiture del metallo di cui è vestita. Circonscritte da profili rigorosi, le concavità morbide ma ben scolpite delle ante segnano il passo ritmato di un gioco di luci ed ombre sottolineato da un'inedita finitura che dona al mobile l'eleganza e la lucentezza della seta.

Sculpt 165 Sideboard DC690
 ← DeSatén copper M17
 ↑ DeSatén brass M16

Brave Mirror P.230
DC671L-G12

Sculpt 205 Sideboard
DC692-M17

Hexagon Frame P.242
DA108

Aare suspended Lighting P.206
DC720-OT-H8 / DC721-OT-H8

Convivium 280 Table P.114
DC530-H3

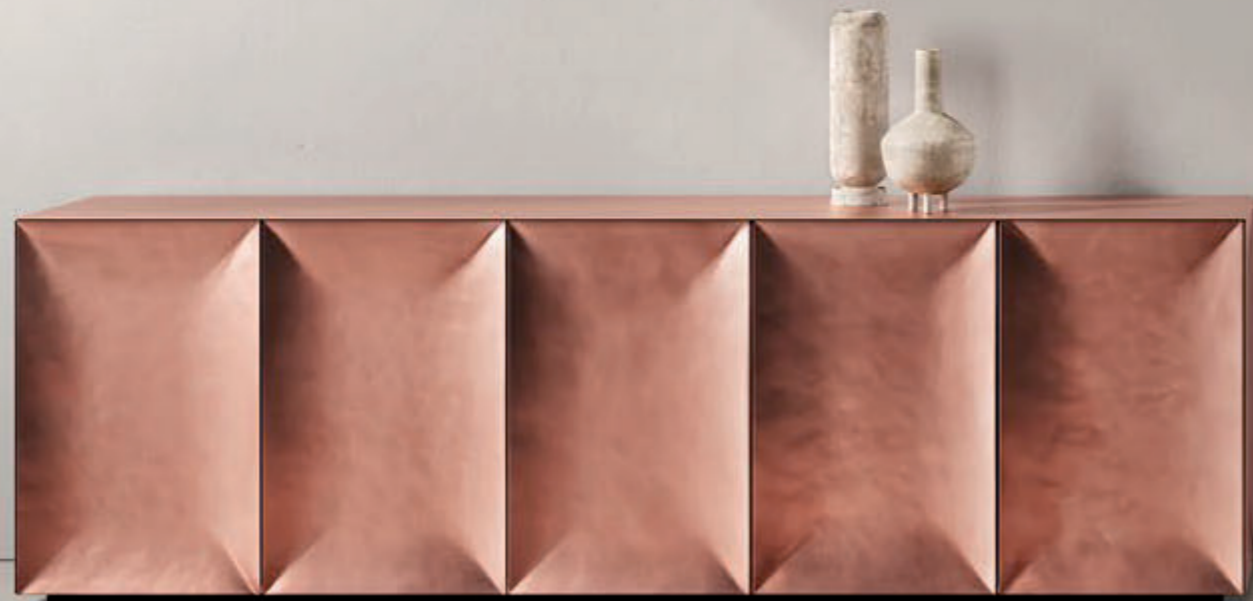
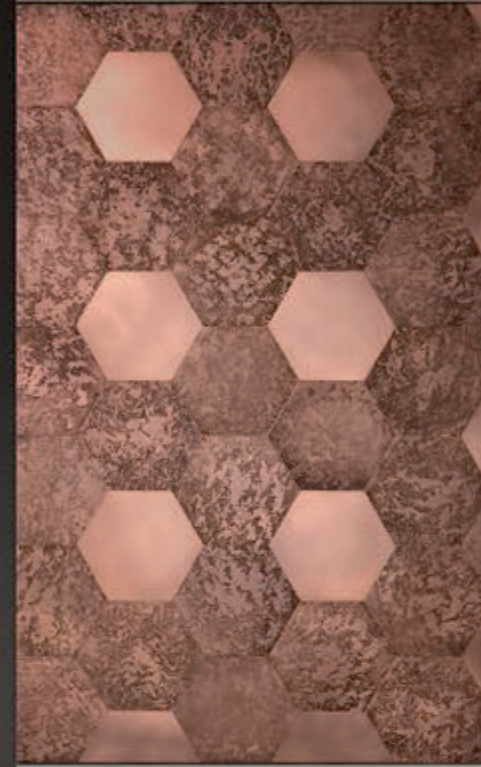



Tako



DATA SHEET P.361

DESIGN BY FILIPPO PISAN

Clean volumes for a console with quite simple lines, emphasising the nobility of the metals that clad the large faces of the drawers. Available both in a hanging and in a free-standing version, Tako evokes the delicate decoration anointed by the DeErosion finish, for a vaguely-Japanese inspired pattern that filters light, modulating its reflections.

Volumi puliti per una consolle dalla linea molto semplice, che enfatizza la nobiltà dei metalli con cui sono rivestiti i grandi frontali dei cassetti. Disponibile sia nella versione sospesa che in quella a terra, Tako rievoca nel grafismo leggero provocato dalla finitura DeErosion l'ispirazione vagamente giapponese di un pattern che filtra la luce modulandone i riflessi.

←
Tako 220 wall-mounted Console DC637
DeErosion on brass OT-H7

↑
Tako 220 floor Console DC637T
DeLabré brass F2

Aare 120 Lighting p.206
DC600-OT-H8

Tako 220 wall-mounted Console
DC637-OT-H4

Parsec 98 Bowl Coffee table p.182
DC621V-F2

Boiserie Wall cladding p.326
DeMarea stainless steel M4





Tako 220 wall-mounted Console DC637
DeErosion on copper RA-H4

→
Tako 110 floor Console DC638T
DeLabré B stainless steel E5



Tako 220 floor Console DC637T
DeLabré B stainless steel E5

Xilo Console



DATA SHEET P.361

DESIGN BY DELINEO DESIGN STUDIO

The Xilo console is a sculptural volume punctuated by different bands of thick metal sheet folded over the top so that they cover the front and create a sort of metaphorical waterfall. Irregularly paired and set on slightly recessed and protruding planes, they are accented by different De Castelli metal finishes. The doors of the suspended console open 90° and provide access to a storage space and a small drawer.

Xilo consolle è un volume scultoreo ritmato dalle diverse fasce metalliche in spessore piegato che rivestono le ante frontali e danno vita a una metaforica cascata. Accostate con irregolarità e leggermente disallineate, sono enfatizzate da diverse finiture sul metallo sviluppate da De Castelli. Le ante della consolle sospesa si aprono a 90° e danno accesso a uno spazio contenitore e a un piccolo cassetto.

← ↑
Xilo 150 wall-mounted Console DC706
Brass OT

CABINETS & SIDEBOARDS

67



Xilo 150 wall-mounted Console DC706
Brass OT



Yoroi



DATA SHEET P.362

DESIGN BY ALESSANDRO MASTURZO

Like the hard metal sheets that identify the armour of a samurai, the scales on the skin of this piece define its appearance. A dynamic shape, taking on the evocative strength of Art Deco furnishings, plays with the essentialism of an ellipse and modular repetition, balanced between minimalism and marvel. With a natural oak frame covered in De Castelli metal, this secretaire opens unexpectedly: it conceals a roomy drawer, two more, while the sides contain curved doors.

Come le lamine in duro metallo identificano le corazze dei samurai, così le scaglie sulla pelle di questo mobile contenitore ne connotano fortemente l'aspetto. Una forma dinamica, che riprende la forza evocativa di un arredo Déco, gioca tra l'essentialità dell'ellisse e la ripetizione del modulo, in equilibrio tra minimalismo e meraviglia. Con struttura in rovere naturale e rivestimento nei metalli De Castelli, il secretaire si apre in modo inatteso: nasconde un ampio cassetto, ne cela altri due con apertura inclinata e sui lati due ante dalla forma ricurva.

Yoroi Sideboard DC510
 ← Orbitale DeLabré stainless steel G2
 ↑ Orbitale DeLabré brass G3



Riflesso Mirrors P.236
DC608-450-G3 / DC608-700-G3 / DC608-900-G3

Yoroi Sideboard
DC510-G4

Boiserie Wall cladding P.326
DeLabré brass F2

Luce solida 30 Lighting P.220
DC469-E5

Marea 55 Bedside table P.34
DC614-M4



Airframe



DATA SHEET P.362

← ↗
Airframe Bookcase DC695
Brushed brass M9

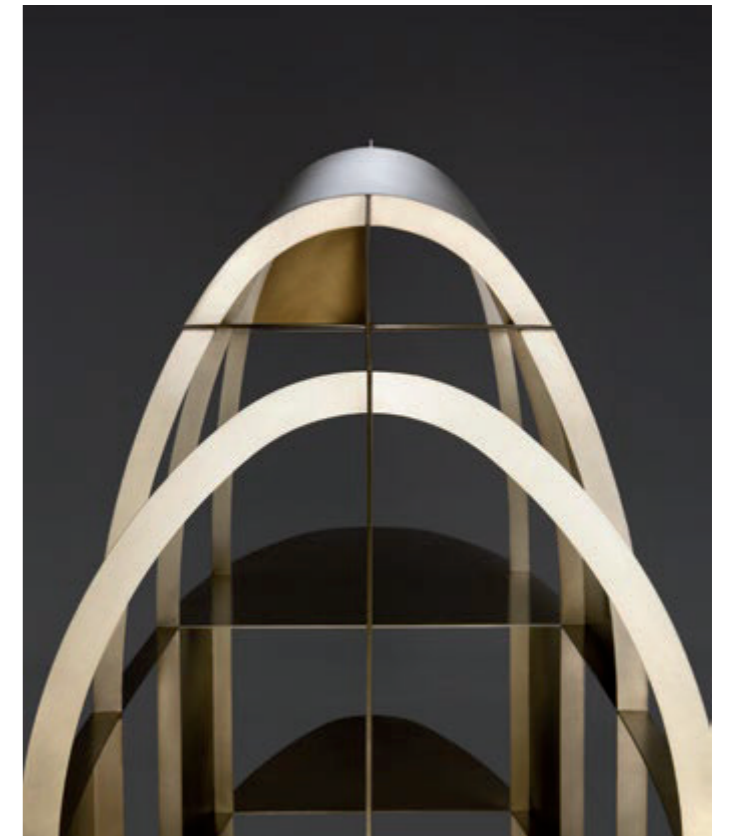

DESIGN BY PIO&TITOSO

The Airframe bookcase celebrates the art of hammered metal, highlighting the savoir-faire and artisan virtuosity that define De Castelli. Its aerodynamic shape outlines a fine metal structure made of asymmetrical elliptical loops, supporting four discontinuous horizontal shelves. The outer shell is composed of a partial covering that has been expertly shaped to the structure. Micro architecture that makes any space more refined, adding a dramatic element to interiors.

La libreria Airframe celebra l'arte della battitura del metallo, esaltando la cultura del saper fare e l'artigianalità. Il design aerodinamico della libreria delinea una sottile struttura metallica di anelli ellittici asimmetrici sulla quale si innestano quattro piani orizzontali non continui, mentre l'involucro è definito da un parziale rivestimento sapientemente modellato sulla struttura. Una micro-architettura che rende prezioso lo spazio, creando una forte presenza scenica nell'interior.



Yoko 01 Frame P.247
DA100

Placas Coffee tables P.184
DC491-G5 / DC490-E11

Airframe Bookcase
DC695-M9

Canneto Barista P.6
DC668-M9

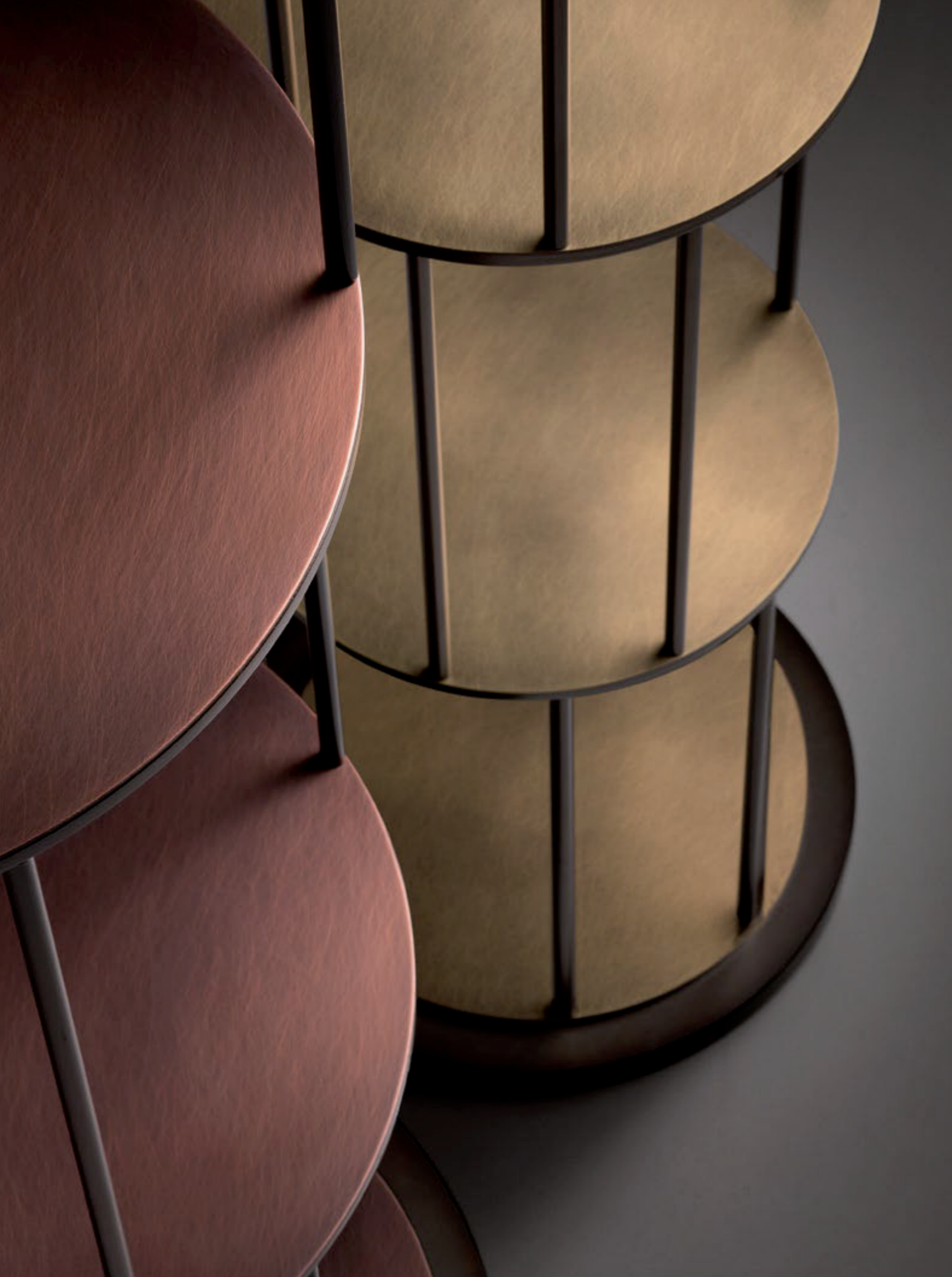

Babele

DATA SHEET P.362

← ↗
Babele 28-8M Bookcase DC635
Orbitale DeLabré brass G3

Babele 36-6M Bookcase DC636
Orbitale DeLabré copper G4

BOOKCASES



DESIGN BY MARTINELLI VENEZIA

Aspirations of higher knowledge find a three-dimensional representation in the striking verticality of this tower bookcase, stripped of all non-essential elements. The svelte modular structure, available in two diameters and in free-standing or wall-mounted versions, was inspired by Athanasius Kircher's legendary depiction of the Tower of Babel, also conceptually linked to the giant "Library" of the same name described in the story by J.L. Borges.

L'aspirazione ad un sapere superiore trova la sua rappresentazione plastica nella verticalità spiccata di questa libreria spogliata di ogni elemento non essenziale. L'asciutta struttura modulare, disponibile in due diverse dimensioni e nelle varianti da centro stanza o a parete, è visivamente ispirata alla leggendaria rappresentazione di Athanasius Kircher della Torre di Babele, e concettualmente legata all'omonima gigantesca "Biblioteca" descritta nel racconto di J.L. Borges.



Babele 28-8M Bookcase DC635
Orbitale DeLabré brass G3

Babele 36-6M Bookcase DC636
Orbitale DeLabré copper G4



7
Babele Bookcases
DC635-4M-G3 / DC636-6M-G4

Boiserie Cladding solution P.326
DeMarea brass M6



Existence Bookcase



DATA SHEET P.363

DESIGN BY MICHELE DE LUCCHI

"Why should bookcases always be straight, long, vertical, right-angle, planes to keep nothing but books perfectly straight and composed? And don't we like to keep a few small objects, keepsakes, some useless artefacts from fundamental phases of our existence, among the books?" Available in free-standing and wall-mounted versions, Existence arose as an overlapping of small, varied boxes, like the experiences and keys to one's life: a totem-bookshelf designed to contain books and objects in a single space, built around similar and repeated modules, though the same form never appears twice.

"Perché mai le librerie devono essere sempre dritte, lunghe, verticali, piane, ortogonali per mettere sempre tutti i libri belli dritti e composti? ...E non è vero che tra i libri ci piace tenere qualche piccolo oggetto, qualche ricordo, qualche inutile reperto di fondamentali fasi della nostra esistenza?" Declinata sia nella versione totem che a parete, Existence nasce come sovrapposizione di piccole scatole tutte diverse, come le esperienze e le letture di una vita: una libreria totem concepita per contenere libri e oggetti in un unico spazio costruito intorno a moduli simili che si ripetono mai uguali a sé stessi.

Existence 5M wall Bookcase DC332
← DeLabré B stainless steel E5
↗ Orbitale DeLabré brass G3



Existence 5M Bookcase DC325
DeLabré B stainless steel E5

Existence 2M Bookcase DC322
DeLabré B stainless steel E5



Existence 5M wall Bookcase
DC332-G3

Syro Coffee tables P.196
DC513-G2 / DC512-G3

Nami



DATA SHEET P.363

DESIGN BY ANDREA PARISIO

Modular bookcase characterized by a sinuous course that also makes it a separate self-standing, if positioned in the center of the room to configure the space. In the "C" composition, Nami embraces like a hug, while in the "S" composition it draws a rhythmic and balanced profile of solids and voids. Striped DeLabré stainless steel structure is enriched by the decorative band, available in precious De Castelli finishes on steel, brass and copper, to furnish the room with personality.

Libreria modulare caratterizzata da un andamento sinuoso che la rende anche un separè self-standing, posizionabile a centro stanza per configurare gli spazi. Nella composizione a "C" Nami avvolge come un abbraccio, mentre in quella ad "S" disegna un profilo ritmato ed equilibrato di pieni e vuoti. La struttura in acciaio inox DeLabré striato è arricchita dalla fascia decorativa, disponibile nelle preziose finiture De Castelli (su acciaio, ottone e rame) per arredare l'ambiente con personalità e carattere.

← ↑
Nami Bookcase DC489
Striped DeLabré brass G7

BOOKCASES



↑
Nami Bookcase
DC489-G6

Caravan 240 Sofa P.140
DC661-M10-AQ

→
Nami Bookcase DC489
Striped DeLabré brass G7



Nippon



DATA SHEET P.363

DESIGN BY ALBERTO NASON

Nippon is a "display case", a piece of furniture designed to hold books, objects and accessories. According to the needs of the space where it will be used, it can become a bookcase, a display cabinet, a notice board, a display module or a container. Its varied depths invite you to discover the most suitable place for each item. The invisible joining system makes it possible to impeccably and seamlessly furnish even large surfaces.

Nippon è un' "oggetteria", complemento d'arredo pensato per ospitare libri, oggetti, accessori. A seconda delle necessità dello spazio nel quale viene utilizzata, diviene vetrina, bacheca, cristalliera, modulo espositivo, contenitore, libreria. Le molteplici possibilità di configurazione e le diverse profondità invitano a scoprire il posto più adatto per ogni cosa. L'invisibile sistema di incastri permette di arredare in modo impeccabile grandi superfici senza alcuna soluzione di continuità.

← ↗
Nippon Bookcase DC488
Waxed natural black iron E3



Talea

DATA SHEET P.364

Talea 115 Bookcase DC650
 ← Orbitale DeLabré stainless steel G2
 ↗ Orbitale DeLabré brass G3

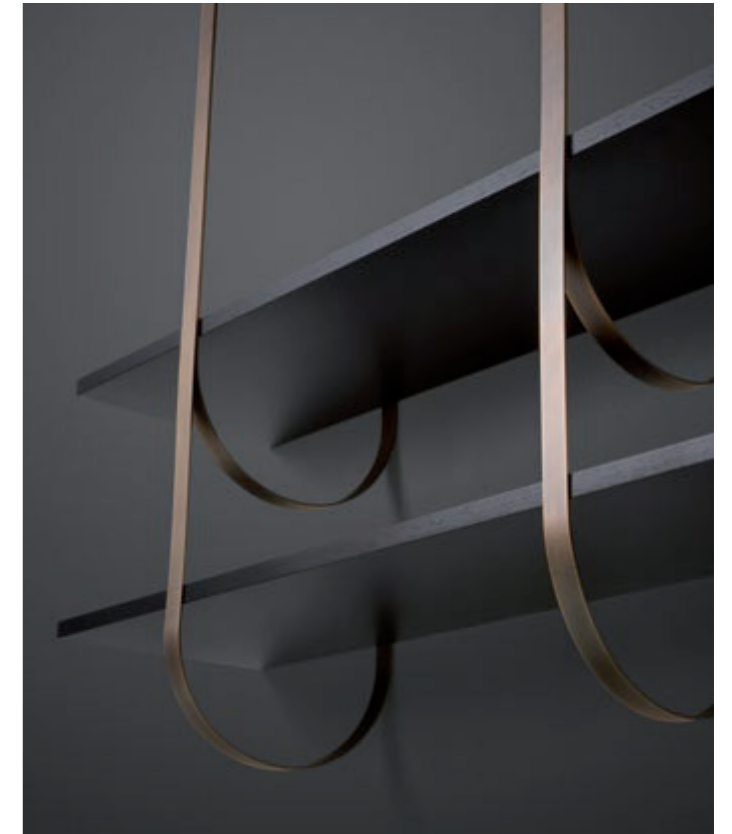

DESIGN BY LUCIDIPEVERE

Thin perpendicular supports fall from the ceiling to be anchored to the wall in delicate curves. Like climbing vines, they create a new kind of suspended architecture. Each branch becomes a support for one or more shelves in a modular composition with clear botanical inspiration. The gaze bounces between the dark hues of the Gabon Ebony shelves and the luminous supports in brass, copper and stainless steel, ennobled by De Castelli finishes.

Sottili supporti perpendicolari si sviluppano a caduta dal soffitto e si ancorano alla parete in curve delicate. Come liane rampicanti, creano nuove architetture pensili. Ogni ramo diventa il supporto per uno o più ripiani in una composizione completamente modulare di chiara ispirazione botanica. Lo sguardo rimbalza fra le scure cromie dell'Ebano Gabon delle mensole e la luminosità dei supporti in ottone, rame o acciaio nobilitati dalle finiture De Castelli.

Elizabeth Console P.22
DC541-M13

Band Coffee tables P.164
DC640-G5 / DC641-F2

Talea 115 Bookcase
DC650-100/200/400/500/600-G4

Talea 185 Bookcase
DC651-100/200/300/400/600-G4





Convivium Console



DATA SHEET P.364

DESIGN BY NIKITA BETTONI

Inspired by the table sharing the same name, Convivium Console leans against the wall with curvy and graceful attitude. Entirely made in brass, this piece stands out for the DeErosion finishing of the top and the flowing movement of its curved legs.

Ispirata all'omonimo tavolo, Convivium Console si appoggia alla parete con movenze sinuose ed eleganti. Completamente realizzata in ottone si caratterizza per la finitura DeErosion del top e dal movimento fluido della curvatura delicata delle gambe.

← ↑
Convivium Console pc529
DeErosion on brass H3

CONSOLES



Existence Console



DATA SHEET P.364

DESIGN BY MICHELE DE LUCCHI

Available in a wall-mounted version, Existence console arose as an overlapping of small, varied boxes, like the experiences to one's life: a console that - as for the totem-bookshelf - is designed to contain books and objects in repeated modules, though the same form never appears twice.

Declinata nella versione a parete, Existence consolle nasce come sovrapposizione di piccole scatole tutte diverse, come le esperienze di una vita: una consolle che - come la libreria - è concepita per contenere libri e oggetti all'interno di moduli simili che si ripetono mai uguali a sé stessi.

← ↑
Existence Console DC675
Orbitale DeLabré brass G3

CONSOLES



Folio Console



DATA SHEET P.364

DESIGN BY DRAW STUDIO

A dramatic, bold yet essential presence defines the Folio console, made of thick brass sheets placed on parallel planes. Exclusive design and style define the base and the top. A linear and three-dimensional 'T' emerges from the lower sheet, creating a dense, precise volume, where positive and negative spaces elegantly interact. Ideal for decorating and creating a surface upon which to put objects, even in narrow spaces such as entries and hallways, it is a natural fit in retail, hospitality and contract settings too.

Una presenza scenica tanto semplice quanto audace definisce la consolle Folio, realizzata con lastre di metallo in spessore poste su piani paralleli, esclusivo linguaggio progettuale per definire sia il basamento che il top. Un segno grafico e tridimensionale a "T" si delinea sulla lastra di fondo creando un volume compatto e preciso, dove i pieni e i vuoti giocano con massima eleganza. Ideale per arredare e creare un piano d'appoggio anche in luoghi stretti come ingressi e corridoi, trova sua naturale applicazione anche in contesti retail, hospitality e contract.

← ↗
Folio Console DC699
DeMarea brass M4

Sinestesia



DATA SHEET P.365

DESIGN BY TIPSTUDIO

A series of curved brass sheets form the base of Sinestesia, the console table encapsulating the solidity and expressiveness of metal. With rounded edges, the leaf-like top of the console rests on the curvature of the metal sheets below, playing with positive and negative spaces to define the essential structure of this piece. The brushed finishing on the inner surface of the vertical elements underscores the essential geometric contours of the piece highlighting the contrast with the outer surface characterised by the DeErosion finishing.

Una successione di lastre curvate caratterizza il design della base di Sinestesia, una console che mette in relazione la solidità e l'espressività del metallo. Il top dagli estremi arrotondati, come una foglia, si appoggia sulla curvatura delle lastre che, in un'alternanza di pieni e vuoti, definiscono la struttura essenziale della console. La finitura della superficie interna delle lastre verticali, evidenzia la geometria essenziale dell'oggetto mettendo in luce il contrasto con la superficie esterna caratterizzata dalla finitura DeErosion.

← ↑
Sinestesia Console DC693
DeErosion on brass OT-H11

Ori Pouf P.144
DC685-G3-126 / DC685-G3-130

Circle wall Decorative P.314
DS701-MIX-OT

Riflesso 120 Mirror P.236
DC608-1200-G3

Sinestesia Console
DC693-OT-H11



Baia



DATA SHEET P.365

← ↗
Baia Table DC667
Top: DeNuance lagoon copper N4
Legs: brushed copper M10

TABLES



DESIGN BY ZANELLATO/BORTOTTO

Large table characterized by an organic shape, inspired by the landscapes of the Venetian lagoon sea: the infinite variations given by the waves and the currents come to life in the evocative declinations of the DeNuance lagoon finish, with its many shades of light blue and green. The base, formed by two cylindrical copper elements, supports the large top with the sinuous line. The result is a sculptural table, an iconic object that becomes the protagonist of the environment: Baia is almost a piece of art, the power and beauty of nature.

Baia è un grande tavolo caratterizzato dalla forma organica, ispirata al paesaggio della laguna veneta: le infinite variazioni date dalle onde e dalle correnti prendono vita nelle suggestive declinazioni della finitura DeNuance laguna, con le sue molteplici sfumature di azzurro e verde. La base, formata da due elementi cilindrici in rame, sostiene il grande piano dalla linea sinuosa. Ne risulta un tavolo scultoreo, un oggetto iconico che diventa protagonista dell'ambiente: Baia è quasi un'opera d'arte, che sprigiona la forza e la bellezza della natura.



Solar Frame P.245
DA106

Baia Table
DC667-NI-E5

Decorative Chandelier
Mix copper finishes

Boiserie Cladding solution P.326
DeDeep stainless steel G12

Monolite Divider P.202
DC694-OT-H11

Burraco



DATA SHEET P.365

← ↗
Burraco Table DC646
Brushed copper M10

←
Burraco Pouf DC647
Brushed copper M10



DESIGN BY ZANELLATO/BORTOTTO

This game table is a throwback to yesteryear with a refined allure, which takes on a whole new value as we find ourselves with increased leisure time at home. The round table top in natural copper is characterised by the distinctive DeErosion finish, made even more special by the playful inclusion of the suits of the different playing cards. Four small serving trays can be extracted from beneath the table top when needed, for placing playing cards or a glass. The table is rounded off with four organically-shaped stools, featuring a copper base and a seat with velvet upholstery.

Il tavolo da gioco, oggetto d'antan dall'allure ricercata, assume un nuovo valore nel ritrovato tempo domestico. Il piano tondo in rame naturale è caratterizzato dalla finitura DeErosion, resa speciale includendo in maniera giocosa i diversi semi delle carte. Quattro piccoli vassoi di servizio possono essere estratti all'occorrenza dal sottopiano per appoggiare il proprio mazzo di carte o un bicchiere. Il tavolo è completato da quattro sgabelli dalla forma organica, con base in rame e seduta rivestita in velluto.

Convivium Table



DATA SHEET P.366

DESIGN BY NIKITA BETTONI

Precious as a jewel, Convivium is a sculptural table that steals centre stage by studding itself with light. Made entirely of brass, it is shaped to ensure stability and resilience, thanks to the discreetly Art Nouveau creases. Like a leaf, it gracefully folds at the edges to offer an ample table top marked by erosions that form dense veining, artfully imitating a material that has been etched and corroded over time. Its flowing, continuous shape lets the eye wander over the dense landscape of markings covering the top, without pause or hesitation.

Prezioso come un gioiello, Convivium è un tavolo scultura che si impone sulla scena ammantandosi di luce. L'ottone è l'unico materiale che lo compone, modellato per assicurare stabilità e robustezza, grazie alle cordonature di vaga ispirazione Art Nouveau. Come una foglia, si piega ai bordi con grazia, per offrire un ampio piano scavato dalle erosioni che formano un disegno di fitte nervature, imitando con arte la materia scalfita e corrosa dal tempo. La sua linea fluida e continua lascia scorrere lo sguardo al denso paesaggio di segni del piano, senza pause o esitazioni.

← ↑
Convivium 220 Table DC534
DeErosion on brass H3

TABLES

115

Babele Bookcases p.80
DC635-4M-G3 / DC636-6M-G4

Convivium 220 Table
DC534-H3

Boiserie Cladding solution p.326
DeMarea brass M6





Coste



DATA SHEET P.366

DESIGN BY LUCA PEVERE

Inspired by the art of origami, the Coste table is an ode to the technique of folding metal. The conical trunk at the centre is composed of the juxtaposition inherent to a folded module, whose 'ribbing' generates a series of isosceles triangles. The different oxidation tones attributed to its faces create the light-dark contrast of chiaroscuro, which accentuates the varied shapes and verticality of the base. The result is the sensation that the circular top is resting on the pointed tips of a crown.

Ispirata all'arte degli origami, il tavolo Coste è un'esaltazione della tecnica di piegatura dei metalli. Il basamento centrale di forma tronco-conica è composto dalla giustapposizione di un modulo piegato la cui costa definisce una successione di triangoli isosceli. I diversi toni di ossidazione attribuiti alle diverse facce creano un effetto chiaroscuro che accentua i volumi ed enfatizza la verticalità della base dando la percezione che il top circolare poggia sulle sole punte di una corona.

↑
 Coste 180 DC676
 Top: DeDeep stainless steel G12
 Base: brushed copper M10

←
 Coste 180 DC676
 Top: DeDeep stainless steel G12
 Base: brushed brass M9

Mida Left Cabinet P.42
DC601-M0

Coste 160 Table
DC677-M9

Vela Cladding solution P.344
DS716-M9

Celato 220 floor Console P.12
DC349-G3





DATA SHEET P.366

DESIGN BY DRAW STUDIO

The pure, precise lines of the Folio table collection are composed of perpendicular planes of metal sheet. Equidistant sheets of metal punctuate the shape of Folio, giving rise to an interesting interplay of shadows, in contrast to the light reflected upon the horizontal plane. The tables are available with a round or a rectangular top and the base is carefully designed to ensure enough leg room while seated.

I volumi puri e precisi della collezione di tavoli Folio sono caratterizzati da una composizione di piani ortogonali realizzati in lastre di metallo. Le lastre equidistanti scandiscono la forma di Folio e generano un interessante gioco di ombre in contrasto con la luce riflettente del piano orizzontale. I tavoli sono disponibili con top tondo e rettangolare e la base di appoggio è attentamente studiata per garantire il giusto confort delle gambe, quando seduti.

← ↑
Folio Table DC698
DeMarea brass M6

Canneté Decorative panel
Orbitale DeLabré aluminum

Folio Table P.122
DC698-M6

Foliage Lighting P.212
DC710-F2

Efesto Stool P.146
DC684-E13

Existence wall Bookcase P.84
CUSTOM 9M-E5





Folio Table bc700
DeDeep stainless steel G12

Plateaux of Mirror



DATA SHEET P.367

DESIGN BY ELISA OSSINO

A sculptural presence and an essential minimalism are the identifying characteristics of this table, made of just three elements: a thick rectangular top which rests on two large concave semi-cylinders, creating a pedestal. The pure, monolithic lines are initially determined by functionality and technique, then by aesthetics, to create a shape that is the maximum expression of the rigour and understatement of proportional harmony.

Presenza scultorea e minimalismo essenziale sono le caratteristiche identificative di un tavolo composto da soli tre elementi: il top rettangolare di alto spessore poggia su due grandi semi-cilindri concavi che ne costituiscono il basamento. Le linee pure e monolitiche sono dettate prima dalla funzionalità e dalla tecnica e poi dall'estetica, per un esito formale che è la massima espressione del rigore e dell'essenzialità associati all'armonia dei volumi.

← ↑
Plateaux of Mirror Table dc670
DeLabré B stainless steel E5

TABLES

Circle wall Decorative P.314
DS701-MIX-RA

Plateaux of Mirror 300 Table
DC670-E5





Roma



DATA SHEET P.367

DESIGN BY MINELLI FOSSATI

← Roma 160 Table DC610
Top: DeOpale stainless steel M0
Feet: brushed copper M10

↑
Roma 137 Table
DC609-OT

Via Veneto Chair P.152
DC654-G3

A table that interprets the round, spacious form of a brazier, which echoes in its size and volume. A symbol of sharing and communion that references the ritual of conviviality and spending time together. The top, in generous proportions, and the lower 'lens' fuse into a single piece, into which three legs are inserted. The personality of this sculpture-table arrives via the iridescent finish of the top, the memory of always-glowing embers, and the luminosity of the copper feet upon which the legs rest, lightening our perception of the whole.

Il tavolo interpreta la forma tonda e capiente del braciere, di cui richiama con evidenza i volumi. Un simbolo di condivisione e di comunione, che rimanda alla ritualità del convivio e dello stare insieme. Il top dalle dimensioni generose e la lente inferiore si fondono in un unico pezzo, nel quale si innestano tre gambe. La personalità di questo tavolo scultura è data dalla finitura cangiante del piano, memoria di braci sempre accese, e dalla luminosità dei piedini in rame su cui poggiano le gambe, che ne alleggeriscono la percezione.



Yoko 02 Frame P.248
DA101

Roma 137 Table
DC609-RA

Riflesso Mirrors P.236
DC608-450-G2 / DC608-700-G3





Vela



DATA SHEET P.367

DESIGN BY R&D DE CASTELLI

Vela is a table-sculpture that explores and enhances the different facets and uses of metal. The stately oval top in Venetian terrazzo made of white marble has been crafted in collaboration with Laboratorio Morsetto to embrace precious inserts of brass in an ethereal composition, a burst of petals floating upon the wind. The table top is juxtaposed with the sculptural three-dimensionality of the base. Soft, sinuous folds unfurl and alternate to create coves that rise into an intricate conical trunk, delicate and solid at the same time.

Vela è un tavolo scultura che esplora e valorizza le diverse sfaccettature e possibili applicazioni del metallo. L'imponente top ovale in seminato veneziano di marmo bianco, realizzato in collaborazione con Laboratorio Morsetto, accoglie e custodisce preziosi inserti di ottone in un'eterea composizione di petali al vento. Il top si contrappone alla tridimensionalità scultorea della base: morbide pieghe sinuose si srotolano in un'alternanza di insenature che plasmano un volume tronco-conico complesso, delicato e solido allo stesso tempo.

← ↑

Vela Table DC669

Top: Venetian-style terrazzo in white marble with brass inserts

Base: orbitale DeLabré brass G3

TABLES

137

Nami Bookcase P.88
DC489-G7

Twist suspended Lighting P.226
DC687-G3

Vela Table
DC669-G3

Celato 160 Chest of drawers P.12
DC343-G3



Caravan



DATA SHEET P.367

←
Caravan 160 Sofa DC660
Brushed brass M9
Acquario Leather

↑
Caravan Armchair
DC657-M10-AQ

Caravan 240 Sofa
DC661-M10-AQ

Drop Coffee table P.172
DC663-N3-M15
DC664-N2-M10

SEATINGS

DESIGN BY EMILIO NANNI

Modular sofa that expresses a harmonious synthesis between the rigor of metal and the softness of the upholstery, which interact in an original formal composure. The profile of the padding is outlined by the precious "horse stitch" stitching, while the base is defined by a metal geometry. The precious metal finish and the sartorial quality of the upholstery create a refined volume, inspired by modernism, which furnish domestic and contract interiors with an important and sculptural presence. Available in two, three or four seat sofa and in the armchair version.

Divano modulare che esprime una sintesi armoniosa tra il rigore del metallo e la morbidezza dell'imbottitura, in un dialogo dall'originale compostezza formale. Il profilo dell'imbottitura è tratteggiato dalla preziosa cucitura a "punto cavallo", mentre la base è definita da una geometria in metallo. Le preziose finiture De Castelli e la qualità sartoriale della tappezzeria disegnano un volume ricercato, di ispirazione modernista, che arreda gli interior domestici e contract con una presenza importante e scultorea. Disponibile nelle varianti divano da due, tre o quattro posti e poltrona.



Loom



DATA SHEET P.368

DESIGN BY FILIPPO PISAN

The Loom collection challenges the apparent contradiction between the hardness of metal and the soft comfort of upholstery. Loom turns an oxymoron into inspiration, positioning a welcoming, familiar form atop a brass clip that embraces as it holds the cushions in place, defining its very shape. Loom embodies the De Castelli approach to the world of upholstery: while respecting the comfort of the ample seat, metal remains the star, truly shining in its role as supporting arms that gently rise up at the sides.

La collezione Loom sfida l'apparente contraddizione tra la durezza risaputa del metallo e la morbidezza confortevole dell'imbottito. Loom fa dell'ossimoro la propria ispirazione, appoggiando le sue forme accoglienti ad una graffa in ottone che nello stringerle le abbraccia, definendone la forma stessa. Loom rappresenta l'approccio di De Castelli al mondo dell'imbottito: il metallo resta protagonista, pur rispettando tutta la comodità della seduta generosa, mettendosi in luce nei supporti che si affacciano gentilmente sui lati.

← ↑
Loom Sofa DC652
Brushed brass M9

↑
Loom Pouf DC653
Brushed brass M9

Ori



DATA SHEET P.368

DESIGN BY STORMO STUDIO

Ori is a pouf-gem in which established elements swap their aesthetic guises and take on new roles. Set like a fine jewel, the detachable cushion with a removable fabric cover becomes the means and the vehicle with which to exalt the brass structure, the true new star of this precious gem. The amplification of the concave form and the artisanal refinement of the finish make it possible for the four 'wedge' legs to go beyond the confines of functionality and, like a diamond, become the catalysts of attention.

Ori è un pouf gioiello i cui elementi fondati invertono la propria veste estetica acquisendo nuovi ruoli. Il cuscino removibile in tessuto sfoderabile, incastonato come una gemma preziosa, diventa il mezzo e l'espedito per esaltare la struttura in ottone, nuova e vera protagonista del prezioso monile. L'amplificazione della forma concava e la raffinatezza artigianale della finitura permettono ai quattro spicchi di appoggio di superare i confini della funzionalità per farsi catalizzatori di attenzione come un diamante.

← ↑
Ori Pouf dc685
Orbitale DeLabré brass G3
St. Moritz L1261 Illiac

↑
Ori Pouf dc685
Orbitale DeLabré brass G3
St. Moritz L1261 light blue

SEATINGS

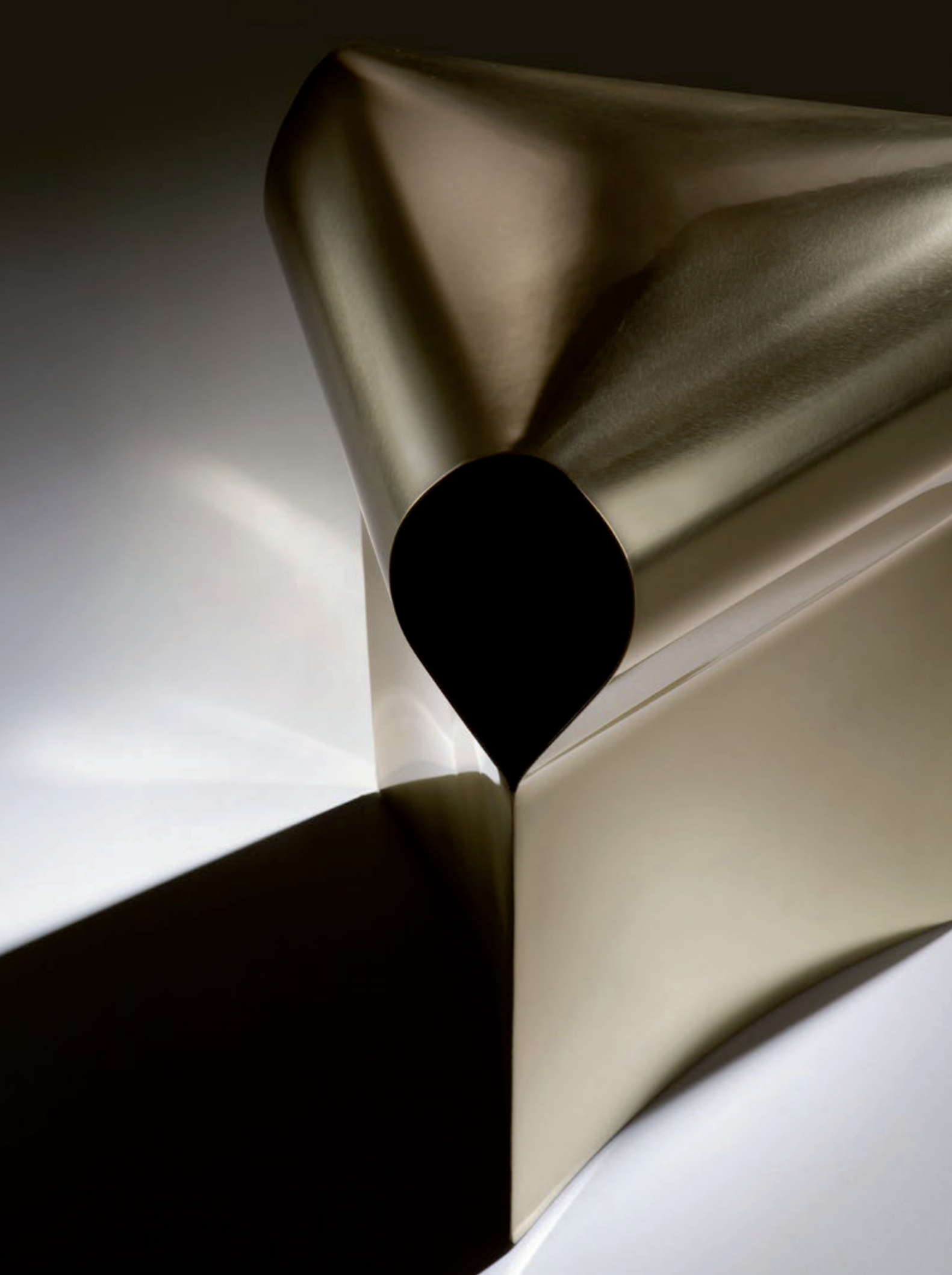

Efesto

DATA SHEET P.368

Efesto Stool DC684
← Polished brass E13
↗ Polished stainless steel D2
Polished brass E13

SEATINGS



DESIGN BY MARTINELLI VENEZIA

More than mere furniture, the Efesto stool is a sculpture for home which exalts the brand manufacturing capabilities: by curving and bending metal sheet, brass is manually shaped and hammered to create its unique triangular cross section. The polished finishing further highlights its sinuous shape. Entirely without mechanical joints, Efesto's ability to support heavy weights is created through its meticulously designed structure. The technical savoir-fair and the intrinsic qualities of brass elevate it beyond a functional object to a unique, sophisticated design piece.

Lo sgabello è una vera e propria scultura domestica che esalta le capacità produttive dell'azienda: ottenuto dalla curvatura, formatura e martellatura manuale della lastra di ottone, è caratterizzato dall'insolita sezione triangolare e da una finitura lucida specchiante che ne esalta la forma sinuosa. Efesto è privo di giunti meccanici e la sua resistenza al peso è data dalla struttura progettuale. L'insieme delle lavorazioni e delle caratteristiche intrinseche dell'ottone lo rendono un oggetto non solo funzionale, ma anche insolito e raffinato.

Pensando ad Acapulco



DATA SHEET P.369

Pensando ad Acapulco DC514
← Polished copper M13
↗ Polished brass M14



DESIGN BY IVDESIGN

Pensando ad Acapulco (Thinking of Acapulco) is a tribute to the iconic Acapulco Chair of the Fifties. It gives shape to a new understanding of what a chair is, starting from metal sheet shaped entirely by hand, fold after fold. Three iron legs support the seat, formed by three sections in shiny copper, steel or brass, enlivened by the refraction of light on each facet sculpted on its surface. The product of De Castelli craftsmanship, expertise and virtuosity, this chair challenges durable metal to become welcoming, even transforming iron into the most flexible of materials.

"Pensando ad Acapulco", rappresenta un omaggio alla mitica Acapulco Chair degli anni '50 ed elabora un nuovo concetto di seduta a partire da lastre metalliche completamente modellate a mano, piega dopo piega. Le tre gambe in ferro sorreggono la seduta formata da altrettanti spicchi in rame, acciaio o ottone lucido, ravvivati dalla rifrazione della luce su ogni faccetta scolpita sulla superficie. Nata dal virtuosismo del sapere artigiano di De Castelli, la seduta sfida la resistenza del metallo e si offre accogliente, trasformando anche il ferro nel più flessibile dei materiali.

Yoroi Sideboard P.70
DC510-G3

Pensando ad Acapulco Chair
DC514-M14

Scomposta Cladding solution P.326
DeDeep stainless steel G12



Via Veneto



DATA SHEET P.369

← ↗
Via Veneto Chair DC654
Orbitale DeLabré brass G3
Orione Doge leather



DESIGN BY MINELLI FOSSATI

The Via Veneto seat is inspired by the 1960s and recalls the atmosphere of the Roman dolce vita. The double symmetrical tubular structure in painted stainless steel designs the feet and the armrests, which support the soft leather upholstered seat and the small shaped metal backrest. The result is an enveloping armchair with carefully studied proportions, which conveys an elegant and sophisticated image.

Si ispira agli anni Sessanta la sedia/seduta Via Veneto, che richiama le atmosfere della dolce vita romana. La doppia struttura tubolare simmetrica in acciaio inox verniciato disegna i piedini e i braccioli, che sostengono il morbido sedile imbottito in pelle e il piccolo poggia schiena in metallo sagomato. Ne risulta una poltroncina avvolgente dalle proporzioni attentamente studiate, che trasmette un'immagine elegante e sofisticata.

Wave



DATA SHEET P.369

Wave Bench dc648
← Brushed copper M10
↗ Brushed brass M9



DESIGN BY LANZAVECCHIA + WAI

With its essential shapes and gentle, sinuous sense of movement, Wave suggests a more conscious focus on the ritual of arriving home reinterpreting a quintessential piece Asian furniture: the shoe bench. The micro architecture plays with curves, solids and voids. The vertical perforated wave-shaped wall lends lightness to the volume and adds a touch of refinement to the sculptural form, accompanying those who enter. The wave form serves to underline the presence of the "pocket emptier" plate, inviting us to empty our pockets as we come home. The upper surface provides ample space to sit down while removing clothing, while the base provides storage space for bags and shoes.

Con le sue forme essenziali e il movimento lento e sinuoso, Wave suggerisce una più attenta consapevolezza nel rito d'ingresso reinterpreting un archetipo asiatico: la shoebench. La micro architettura gioca con le curve, i pieni e i vuoti. La parete verticale a onda traforata alleggerisce il volume e ingentilisce la forma scultorea, accompagnando il moto di entrata. Il movimento sottolinea la presenza del piatto "svuotatasche", invitando a depositare gli oggetti che portiamo da fuori. Un ampio piano permette di sedersi per la svestizione, la base accoglie e custodisce borse e scarpe.



DATA SHEET P.369

DESIGN BY STORMO STUDIO

Alchemy is an ancient art whose main goal was to convert humble metals to precious ones, using an esoteric language to give materials a metaphysical quality. The Alchemy collection was inspired by this magic science, resulting in changeable compositions of tables that come together in immediate formal chemistry. Chromatic variations emphasise the expressivity of the materials and the concave shape of the bases refracts the luminosity of stainless steel, contrasting with the textural geometries of the DeLabré copper, brass and stainless steel tops.

L'alchimia è un sapere antico il cui fine primo era quello di trasmutare i metalli vili in metalli preziosi, avvalendosi di un linguaggio esoterico che conferiva al materiale una dimensione metafisica. La collezione Alchemy trae ispirazione da questa scienza magica per creare composizioni mutevoli di tavolini che, combinandosi insieme per immediata intesa formale, danno luogo a variazioni cromatiche ed enfatizzano l'espressività del materiale. La forma concava delle basi rifrange la luminosità dell'acciaio inox a cui si contrappone la geometria tattile dei top in rame, ottone e acciaio DeLabré.

← ↑
Alchemy 50 Coffee table bc628
DeLabré copper G5

↑
Alchemy 35 Coffee table bc626
DeLabré stainless steel E11

Alchemy 70 Coffee table bc629
DeLabré stainless steel E11

Alchemy Bench bc627
DeLabré brass F2

COFFEE TABLES

Celato 130 Chest of drawers p.12
DC346-E6

Yoko 01 Frame p.247
DA100

Luce Solida 42 Lighting p.220
DC470-F2

Alchemy Coffee tables
DC626-E11 / DC628-G5 / DC627-F2



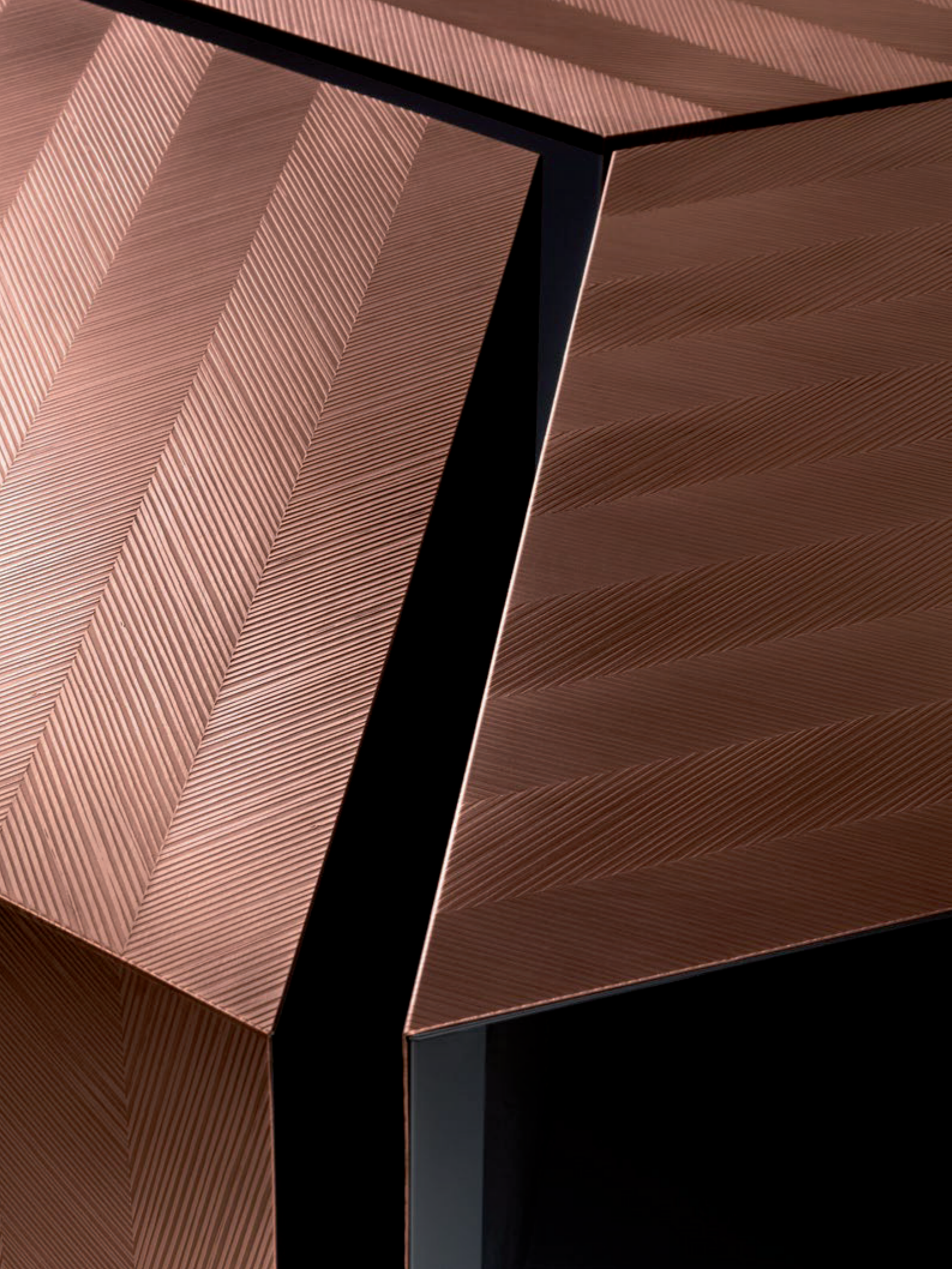

Alpha

DATA SHEET P.370

Alpha Coffee table DC649
← DeErosion on copper H12
↗ DeErosion on brass H12

COFFEE TABLES



DESIGN BY MARTINELLI VENEZIA

A small rhomboid-shaped table with storage space. Its simple shape renders it modular: by combining it with other identical elements, either moved around or rotated, numerous configurations can be obtained. Thanks to the measured proportions and the compositional possibilities, Alpha can fit into any environment and can be used in many different ways. The DeErosion technique on copper or brass creates a diagonal striped pattern that enhances the geometric shape and emphasises the graphic effect.

Un piccolo tavolo contenitore a base romboidale. La forma semplice lo rende modulare: abbinandolo con altri elementi uguali, traslati o ruotati, è possibile infatti ottenere numerose configurazioni. Grazie alle proporzioni misurate e alle possibilità compositive, Alpha può inserirsi in tutti gli ambienti con diverse funzionalità. La tecnica DeErosion su rame o ottone crea un pattern a righe diagonali che valorizza le geometrie ed enfatizza l'effetto grafico.



Alpha Coffee table DC649
DeErosion on copper H12



Alpha Coffee table
DC649-H12

DeErosion Tile P.272
DS107-H4M-RA



Band

DATA SHEET P.370

← ↗
Band 55 Coffee table DC640
DeLabré copper G5

Band 60 Coffee table DC641
DeLabré brass F2

Band 65 Coffee table DC642
DeLabré stainless steel E11

COFFEE TABLES



DESIGN BY BALDESSARI E BALDESSARI

The Band table set creates 'micro architecture' whose most distinctive trait is lightness. Long, slender legs support thin circular table tops, where metal nuances vibrate. In stainless steel, brass and copper, these multifaceted objects gracefully and discreetly wear the sophisticated shades of De Castelli metals. In different heights, they form a group of complementary, harmonious pieces destined to last over time.

Il set di tavoli Band compone un insieme di micro architetture il cui tratto più evidente è la leggerezza. Gambe lunghe e affilate sostengono dei piani sottili di forma circolare dove vibrano le sfumature del metallo. In acciaio, ottone, rame, sono oggetti poliedrici, in grado di portare con grazia e discrezione le sofisticate sfumature dei metalli De Castelli. Proposti ad altezze diverse, formano un gruppo di arredi complementari ed armonici destinati a durare nel tempo.



Between Nature



DATA SHEET P.370

DESIGN BY STORMO STUDIO

↑
Between Nature 20 DC682
 Brushed brass,
 "Zebrato" marble IPOGEO® collection
 by Margraf Innovation Lab

← ↑
Between Nature 40 DC683
 Hammered polished brass, Brushed brass,
 "Breccia imperiale" marble IPOGEO®
 collection by Margraf Innovation Lab

The romantic idea of an organicistic, vitalistic and dialectical nature is the concept of Between Nature. We look at an organized nature in which the parts live in function of the whole; nature as a structured and dynamic reality that manifests itself in the artifact. Characterized by a monolithic base in marble by IPOGEO® by Margraf Innovation Lab, the tables welcome metal trays in different shapes, that seem to float on the marble surfaces. Between Nature celebrates the collaboration between De Castelli and Margraf.

L'idea romantica di natura organicistica, vitalista e dialettica è il concept di Between Nature. Guardiamo a una natura organizzata nella quale le parti vivono in funzione del tutto; natura come realtà strutturata e dinamica che si manifesta nell'artefatto. Caratterizzati da una base monolitica in marmo della collezione IPOGEO® by Margraf Innovation Lab, i tavolini accolgono vassoi in metallo di varie forme, che sembrano galleggiare sulle superfici marmoree. Between Nature celebra la collaborazione tra De Castelli e Margraf.

Botero

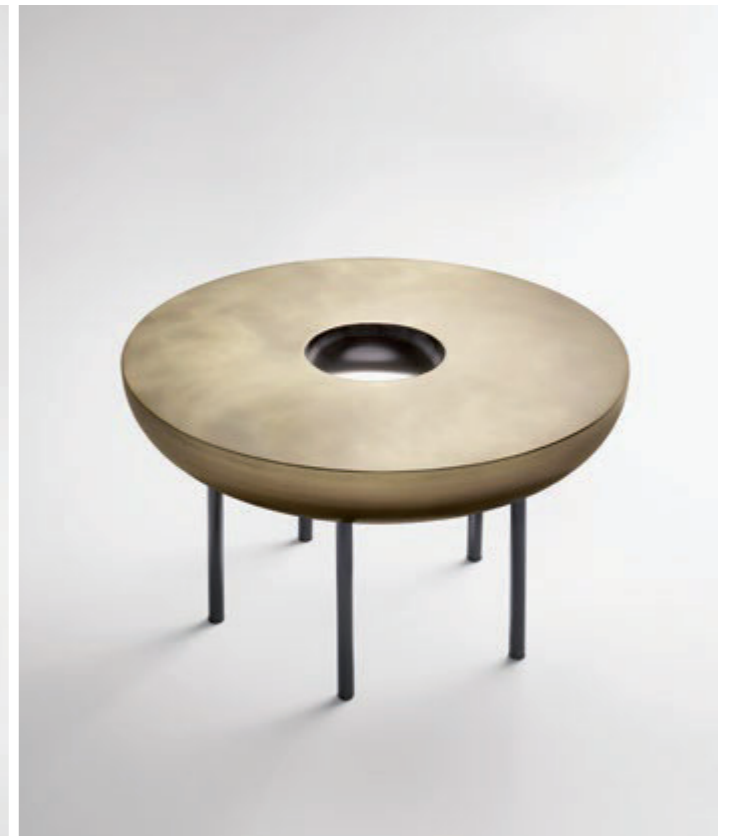

DATA SHEET P.370

DESIGN BY R&D DE CASTELLI

Botero, a large side table, embodies refined technical expertise in its details and aesthetics. The artisanal technique used to create its rounded surface has been recovered and re-interpreted by De Castelli, transforming this sculptural object into the quintessence of complexity and formal sophistication. The central opening offers glimpses of a curved, soft shape rendered solid by the masterful work executed to weld the top and the legs to the central element.

L'estetica di Botero, generoso tavolino, cela in dettaglio una raffinata expertise tecnica. La bombatura, tecnica artigianale recuperata e re-interpretata da De Castelli, trova in questo oggetto scultoreo l'apice della complessità e il suo esito formale più sofisticato. Il foro centrale permette di leggere le curvature di un volume morbido e reso solido dalla magistrale saldatura che lega il top e le gambe al corpo centrale.

↑
Botero 15 Coffee table dc689
DeErosion H13 on brass OT-H13

← ↗
Botero 50 Coffee table dc681
Brushed brass M9

COFFEE TABLES



Scomposta Cladding solution P.326
DeLabré stainless steel E11

Botero Coffee tables
DC681-M9 / DC689-OT-H13

Aare 80 Lighting P.206
DC599-F2

Marea 190 Dresser P.34
DC644-M4

Drops



DATA SHEET P.371

- ← ➤
Drop 38 Coffee table DC664
 Top: DeNuance ocean copper N2
 Base: brushed copper M10
- ←
Drop 30 Coffee table DC663
 Top: DeNuance verdigris copper N3
 Base: matt black lacquered stainless steel M15
- ←
Drop 52 Coffee table DC665
 Top: DeNuance forest copper N1
 Base: brushed copper M10



DESIGN BY ZANELLATO/BORTOTTO

Drops is a family of coffee tables inspired by the unexpected, irregular shapes of water droplets on a surface. Their soft, familiar lines embody the skilled craftsmanship and artisan know-how of De Castelli, which has revived the traditional technique of manually hammering. The tables are thus a nod to a tradition that, given a contemporary interpretation, is manifested in products that harmoniously integrate with everyday settings. The DeNuance finishing, inspired by water and the way it moves, further enhances the tops, giving each piece an organic, natural look thanks to the combination of fire, oxidation and pigments.

Drops è una famiglia di tavolini che richiama le forme inaspettate e irregolari delle gocce d'acqua su una superficie. Dietro alle linee morbide e familiari dei tavolini si cela il sapiente lavoro e know how artigianale di De Castelli che recupera la tecnica tradizionale della battitura a mano. Uno sguardo quindi alla tradizione che, reinterpretata in chiave contemporanea, plasma prodotti capaci di integrarsi armoniosamente in un contesto quotidiano. La finitura DeNuance, ispirata all'acqua e ai suoi movimenti, valorizza i top conferendo all'oggetto un aspetto organico e naturale grazie all'azione combinata di fuoco, ossidazione e pigmenti.



Drop 30 Coffee table DC663
Top: DeNuance verdigris copper N3
Base: matt black stainless steel M15

Drop 38 Coffee table DC664
Top: DeNuance ocean copper N2
Base: brushed copper M10

Drop 52 Coffee table DC665
Top: DeNuance forest copper N1
Base: brushed copper M10



Flocks

DATA SHEET P.371

← →
Flock 32 Coffee table DC731
DeErosion on brass OT

Flock 38 Coffee table DC732
DeErosion on brass OT

Flock 45 Coffee table DC730
DeErosion on brass OT

COFFEE TABLES



DESIGN BY MATTEO ZORZENONI

The Flocks table collection was inspired by the sinuous and hypnotic movement of flocks of birds in the autumn sky. The tops of these side tables are made of sheets of brass or copper, in simple circles or intersecting circular shapes, resting on one or two cylinders of different diameters. Chromatic contrast is accentuated by the graphic pattern of the DeErosion finishing: the table tops gain a three-dimensional, tactile aspect that emerges on the surface with natural refinement.

La collezione di tavolini Flocks si ispira al movimento sinuoso e ipnotico degli stormi nel cielo autunnale. I top dei tavolini sono realizzati in lastra di ottone o rame, dalle forme circolari semplici o intersecate, che poggiano su uno o due cilindri di diversi diametri. Il contrasto cromatico è accentuato dal pattern grafico ottenuto con la finiture DeErosion che caratterizza il top regalando una sensazione tattile tridimensionale che affiora sulla lastra con naturale raffinatezza.



Flock 32 Coffee table DC731
DeErosion on brass OT

Flock 38 Coffee table DC732
DeErosion on brass OT

Flock 45 Coffee table DC730
DeErosion on brass OT



Nicola



DATA SHEET P.371

- ←
Nicola 45 Coffee table DC625
DeOpale copper M2

Nicola 50 Coffee table DC624
DeOpale stainless steel M0

Nicola 55 Coffee table DC623
DeOpale brass M3

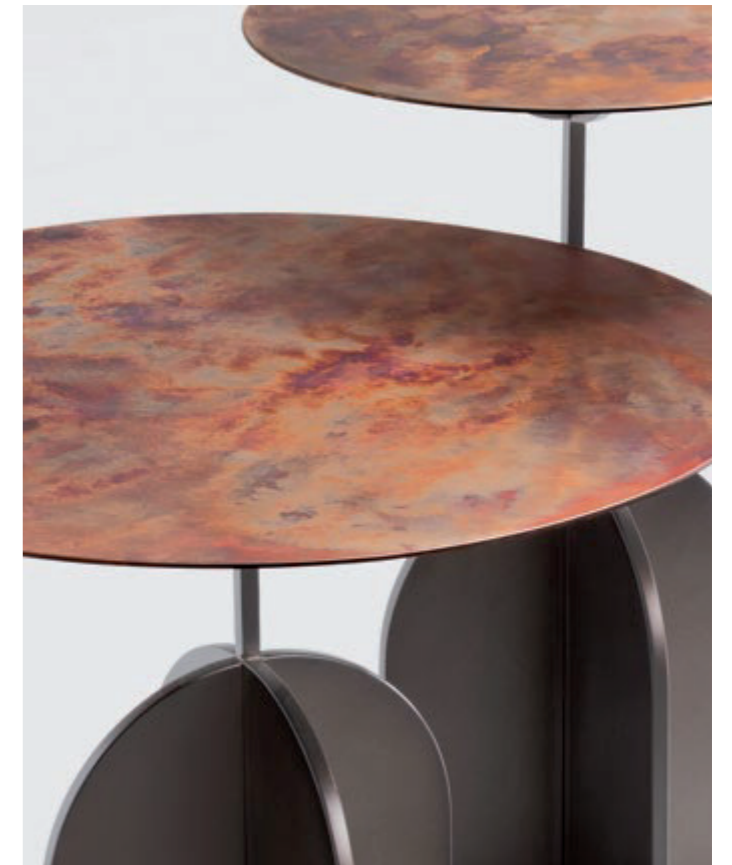

DESIGN BY IVDESIGN

Decisive geometries for a table characterized by the superimposition of three apparently-contrasting elements. The robust cross-shaped base anchors the structure to the ground, while the thin round top rests on a slender stem, like a delicate leaf that emerges from deep roots. The base and the stem are in DeLabré iron, while the top is enhanced by different refined metals and De Castelli finishes.

Geometrie decise per un tavolino caratterizzato dalla sovrapposizione di tre elementi in apparente contrasto. L'importante base a croce ancora a terra la struttura, mentre il sottile piano rotondo poggia su un esile stelo, quasi come una foglia delicata che germoglia da radici profonde. La base e lo stelo sono in ferro DeLabré, mentre il top viene valorizzato dalla preziosità dei diversi metalli e finiture De Castelli.

Parsec



DATA SHEET P.371

←
Parsec 98 bowl Coffee table DC621V
DeOpale brass M3

↗
Parsec 98 Coffee table DC621
DeOpale brass M3

Parsec 98 bowl Coffee table DC621V
DeOpale stainless steel M0



DESIGN BY EMILIO NANNI

The Parsec collection of Coffee tables is characterized by the interwoven tube structure which forms the base. The legs create diagonals connected by a central joint upon which the force lines converge. The top and centrepiece are attached to the joint, which becomes a linchpin for the entire structure. Available with or without the central accessory, Parsec juxtaposes De Castelli finishes in stainless steel, brass and copper with the burnished stainless steel of the frame, opting for chromatic balance in an item defined by formal rigour.

La collezione di tavolini Parsec è caratterizzata dall'intreccio della struttura tubolare che forma la base; le gambe disegnano diagonali connesse da un giunto centrale su cui convergono le linee di forza. Ad esso sono fissati il piano e il centrotavola, che diventa perno di tutta la struttura. Disponibile con o senza accessorio centrale, Parsec contrappone le finiture De Castelli di acciaio, ottone e rame all'acciaio inox brunito della struttura, scegliendo il bilanciamento cromatico per un oggetto che fa del rigore formale il proprio DNA.



Placas



DATA SHEET P.372

←
Placas 60 Coffee table DC491
DeLabré brass F2

Placas 100 Coffee table DC490
DeLabré brass F2

↑
Placas 60 Coffee table DC491
DeLabré brass F2
DeLabré copper G5

Placas 100 Coffee table DC490
DeLabré stainless steel E11
DeLabré brass F2

COFFEE TABLES

DESIGN BY LUCIDIPEVERE

Three wedges, or three petals, open to create a circular table top, held together by the supporting frame of the legs. Simple yet effective design emphasizes the geometric nature of the design, highlighting the expressivity of the material, ennobled by the DeLabré finish. Easily assembled, they play upon modular repetition and the solidity of the frame, which brings stability, guaranteed by strong DeLabré iron legs resting on cast brass feet.

Tre spicchi, o tre petali, si schiudono per offrire un piano d'appoggio circolare, tenuto insieme dalla struttura di sostegno delle gambe. Un disegno semplice ed efficace mette in risalto il segno grafico del progetto evidenziando l'espressività del materiale nobilitato dalla finitura DeLabré. Facilmente accostabili, giocano sulla ripetizione del modulo e sulla solidità della struttura che ne assicura la stabilità, garantita da forti gambe in ferro DeLabré poggiate su piedini in fusione d'ottone.



↑
Placas 60 Coffee table DC491
DeLabré copper G5

Placas 100 Coffee table DC490
DeLabré stainless steel E11



Decorative Panel
DeSalt brass M7

Loom Sofa P.142
DC652-M9

Loom Pouf P.142
DC653-M9

Placas Coffee tables
DC491-G5 / DC490-F2

Scribble



DATA SHEET P.372

DESIGN BY FRANCESCA LANZAVECCHIA

Essential signs, like the undulating curves drawn by a calligraphy pen, or the clean, sinuous lines of a marker, are a metaphor for the malleability of metals when the hand that forges them knows all their secrets. The cold elegance of metal is thereby softened, giving it character, colour and feminine appeal. These symbols and characters chase each other almost as if dancing, manifesting as side tables and surfaces ready to invent a new domestic alphabet and to write new stories of conviviality.

Segni essenziali come le curve dolci tracciate da un pennello calligrafico o le linee nitide e sinuose di un pennarello sono la metafora della malleabilità dei metalli quando la mano che li forgia ne conosce tutti i segreti. L'intento è rendere "morbida" l'algida eleganza del metallo, conferendogli carattere, colore e un appeal più femminile. Questi segni s'inseguono quasi come in una danza, diventando tavolini e piani d'appoggio pronti a disegnare un nuovo alfabeto domestico e a scrivere nuove storie di convivialità.

←
Scribble Bracket Coffee table DC549
Striped DeLabré brass G7

Scribble Accent Coffee table DC547
Orbitale DeLabré brass G3

↑
Scribble Coffee tables

COFFEE TABLES



↑
Scribble Tilde Coffee table DC548
Rubin copper G11

Scribble Parenthesis Coffee table DC545
Verdigris copper F7

Scribble Comma Coffee table DC546
DeLabré black iron G1

Scribble Dot Coffee table DC544
DeOpale brass M3

Scribble Comma Coffee table
DC546-G1

Scribble Dot Coffee table
DC544-M3

Boiserie Cladding solution P.326
DeOpale stainless steel M0



Sunrise & Sunset



DATA SHEET P.372

DESIGN BY ARTEFATTO

Two side tables, like large suns, emphasize the textural and chromatic characteristics of copper and brass. Contrasting with the DeLabré iron of the base, the top is ennobled by a hand-crafted finish. Here the material takes shape in all its purity, fading from a luminous centre towards gradually oxidised tones, thanks to a controlled, measured treatment. The various proportions of the complementary tables suggest the two moments of the day when the light is most intriguing, when the sun rises, large in the sky, and when it sets, smaller, on the horizon.

Due tavolini, come grandi soli, enfatizzano le caratteristiche materiche e cromatiche del rame e dell'ottone. A contrasto con il ferro DeLabré della base, il piano è nobilitato dalla finitura realizzata completamente a mano; qui il materiale si manifesta in tutta la sua purezza, sfumando da un centro luminoso verso tonalità gradualmente più ossidate, grazie ad una controllata e graduale lavorazione. Le diverse proporzioni dei due tavolini suggeriscono i due momenti del giorno in cui la luce si fa più intrigante, quando il sole sorge grande nel cielo e tramonta più piccolo all'orizzonte.

← →
Sunset Coffee table DC536
Gradual oxidation on copper RA

Sunrise Coffee table DC535
Gradual oxidation on brass OT

COFFEE TABLES

193



Sunset Coffee table DC536
Gradual oxidation on copper RA

Decorative Panel
DeOpale stainless steel M0

Talea 185 Bookcase P.94
DC651-200/300/400/500/600-G4

Sunset & Sunrise Coffee tables P.192
DC536-OT / DC535-RA



Syro



DATA SHEET P.372

DESIGN BY EMILIO NANNI

In organic shapes, this triptych of small tables is supported by a slender rebar structure and is characterized by geometric shapes etched on the metal sheet tops. Flowing forms, almost primitive markings, material combinations and chromatic variations are combined: stainless steel, brass and copper are mixed repeatedly with shapes inspired by circles that branch out into the water, into the flowing current and the rippling waves. The connecting bars of the frame, positioned at the same height from the ground, form a natural weave, like branches of the same plant, in a fluid, balanced composition.

È un trittico di piccoli tavoli dalla forma organica, sostenuti da un'esile struttura in tondino e caratterizzati da grafismi incisi sulla lamiera. È una combinazione di forme fluide, segni quasi primitivi, accostamenti materici, variazioni cromatiche: acciaio, ottone e rame, si mescolano ripetutamente con forme ispirate ai cerchi che si diramano nell'acqua, al flusso della corrente e all'increspatura delle onde. I traversi di collegamento della struttura, posizionati alla stessa altezza da terra, formano un intreccio naturale, come rami di un'unica pianta, in una composizione fluida ed equilibrata.

↑
Syro 45 Coffee table bc511
Orbitale DeLabré copper G4

← ↗
Syro 30 Coffee table bc513
DeLabré B stainless steel E5

Syro 37 Coffee table bc512
DeLabré B stainless steel E5

Syro 45 Coffee table bc511
Orbitale DeLabré brass G3

COFFEE TABLES



Syro XL



DATA SHEET P.373

DESIGN BY EMILIO NANNI

An oversized version of the Syro side tables, Syro XL is characterized by the DeErosion finish that defines the top. Deep erosions in the metal create landscapes along the generous proportions of the form, enhancing its features and the elegant imperfection of hand-worked craftsmanship.

La versione oversize dei tavolini Syro è caratterizzata dalla finitura DeErosion che ne contraddistingue il top. Le erosioni profonde nel metallo disegnano paesaggi iscritti nella dimensione generosa della forma, che ne valorizza il tratto e la ricercata imperfezione della lavorazione manuale.

- ← ↗
Syro XL 88 Coffee table dc630
DeErosion H7 on brass OT-H7
- Syro XL 98 Coffee table dc631
DeErosion H6 on copper RA-H6
- Syro XL 120 Coffee table dc632
DeErosion H3 on stainless steel IX-H3

Xilo Coffee table



DATA SHEET P.373

Xilo Coffee table dc697
← DeGlyphé alfa brass L1
↗ DeGlyphé beta brass L2

DESIGN BY DELINEO DESIGN STUDIO

Inspired by the refined, sinuous aesthetics of Art Nouveau, the Xilo coffee table is a veritable sculpture in metal that exalts the memory of forging techniques. Three sheets of thick brass, rounded at the ends and of different lengths, have been folded and abutted irregularly to create rhythmic movement. Each element features a distinct weave of imprints that dissolve in delicately fading marks, in contrast to the polished brass surface.

Ispirato all'estetica raffinata e sinuosa dell'Art Nouveau, il tavolino Xilo è una vera e propria scultura in metallo che esalta la memoria delle tecniche di forgiatura. Il tavolino è composto da lastre in ottone in spessore, stondate alle estremità e di diverse lunghezze, piegate e accostate con irregolarità per creare un movimento ritmato. Ogni elemento presenta una distintiva trama di impronte che si dissolvono in un delicato dégradé di segni, in contrasto con la superficie levigata del metallo.

Monolite



DATA SHEET P.373

← ↗
Monolite Divider DC694
DeErosion H11 on brass OT-H11



DESIGN BY TIPSTUDIO

Monolite is an architectonic partition that, like a solid body smoothed by natural erosive elements, evokes geological formations along its surface. It is characterised by its precise clean, graphic lines, making it the star of any space. This partition is a vertical element constituted by two symmetrical, concave brass metal sheets that come together at the back. Within they conceal a light source, which shines mysteriously from a hidden crevice. Sharp contrast between the rough, uneven texture of the inner surface, and the outer surface, with its notably smooth and reflective brushed finish, defines the partition.

Monolite è un divisorio architettonico che, come un corpo massiccio levigato in natura da azioni erosive, evoca formazioni geologiche sulla sua superficie. Il suo design è caratterizzato da un segno grafico preciso che lo rende protagonista dello spazio in cui viene collocato. Il divisorio è un elemento verticale costituito da due lastre in ottone simmetriche concave che si sfiorano sul dorso. Al loro interno custodiscono una luce, che proviene misteriosa da una fessura nascosta. Il divisorio presenta un netto contrasto tra la texture della sua superficie interna, ruvida e irregolare, e quella esterna, che si distingue per la sua spazzolatura liscia e riflettente.

Painting



DATA SHEET P.373

← ↗
Painting Divider DC540
Mix metal finishes



DESIGN BY ALESSANDRA BALDERESCHI

A large screen designed as a theatre curtain represents imaginary natural landscapes on both sides: a night sky and the outline of a series of hills. The chromatic variations obtained thanks to the different surface oxidations resemble the colours of a painting on canvas, with the resulting image becoming a stage backdrop. Brushed copper and DeLabré brass shape the outlines of a distant space, while the textural black of the metal sheet juxtaposes with the airy verdigris in the imaginative construction of a changing landscape.

Un paravento di grandi dimensioni pensato come una quinta teatrale che rappresenta su ciascun lato paesaggi naturali immaginari, un cielo notturno e un profilo collinare. Le variazioni cromatiche ottenute grazie alle diverse ossidazioni sui materiali sono paragonabili ai colori di un pittore su una tela: il risultato è un dipinto che diventa scenografia. Il rame spazzolato e l'ottone DeLabré delineano le sagome di uno spazio lontano, mentre il nero materico della lamiera si contrappone all'aereo verderame nella costruzione fantastica di un paesaggio cangiante.

Aare



DATA SHEET P.374

← ↗
Aare 120 Lighting pc600
DeErosion H8 on brass OT-H8

LIGHTINGS



DESIGN BY ALEXANDER PURCELL

The Aare Gorge in Switzerland is testimony to natural erosion, shaped by the last ice age. Here, a river originated from melting glaciers once carved deep into the rock, cutting to its core. Thus, little by little, light began working its way into the cracks, amid ancient limestone stratifications. Thanks to a centre slit, these lamps take on the archetypical form of earthly geography sculpted by ice, reproducing its prehistoric beauty, as if they were forged centuries ago. Aare is available as a wall sconce or a pendant lamp.

La gola di Aare, in Svizzera, testimonia l'erosione naturale, conseguenza dell'ultima glaciazione. Qui, un torrente originatosi dallo scioglimento dei ghiacciai ha inciso profondamente la roccia, tagliandola nel vivo; così nelle sue fessure si insinua a poco a poco la luce, tra millenarie stratificazioni calcaree. Grazie al taglio centrale, le lampade si mostrano nella forma archetipica della natura scavata dal ghiaccio, replicandone la preistorica bellezza, come fossero state forgiate secoli fa. Aare è disponibile in versione applique a parete e a sospensione.

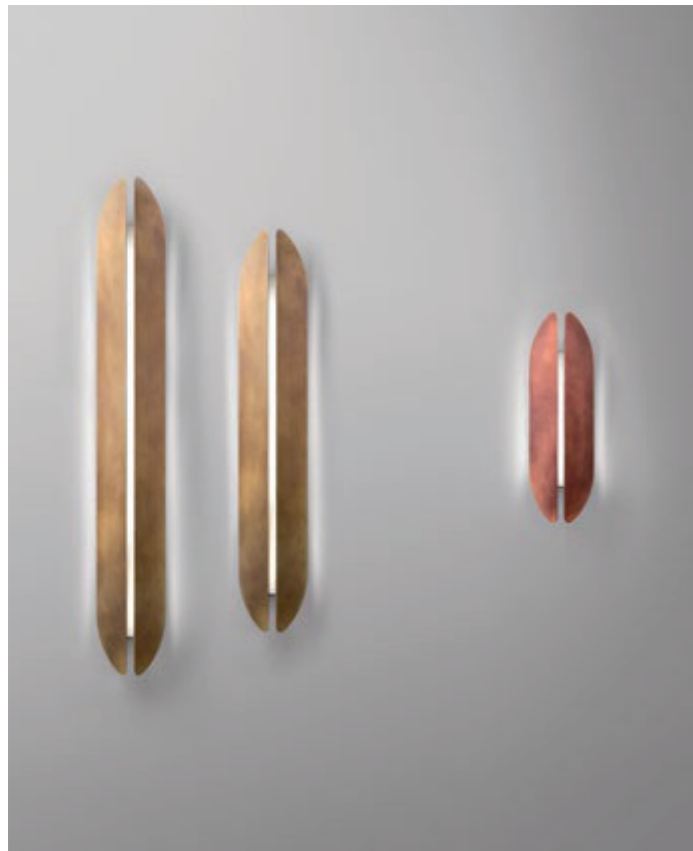

←
Aare 120 Lighting DC600
DeLabré brass F2

Aare 80 Lighting DC599
DeLabré brass F2

Aare 45 Lighting DC598
DeLabré copper G5

↙
Aare 120 Lighting DC600
DeErosion H8 on stainless steel IX-H8



Aare 120 Lighting
DC600-OT-H8

Tako 220 wall-mounted Console P.60
DC637-OT-H4

Parsec 98 Bowl Coffee table P.182
DC621V-M3



←
Aare Ceiling 120 Lighting dc720
DeErosion H8 on brass OT-H8

Aare Ceiling 180 Lighting dc721
DeErosion H8 on brass OT-H8

↗
Aare 120 Lighting dc600
DeGlyphé brass epsilon L5
DeGlyphé brass gamma L3

LIGHTINGS

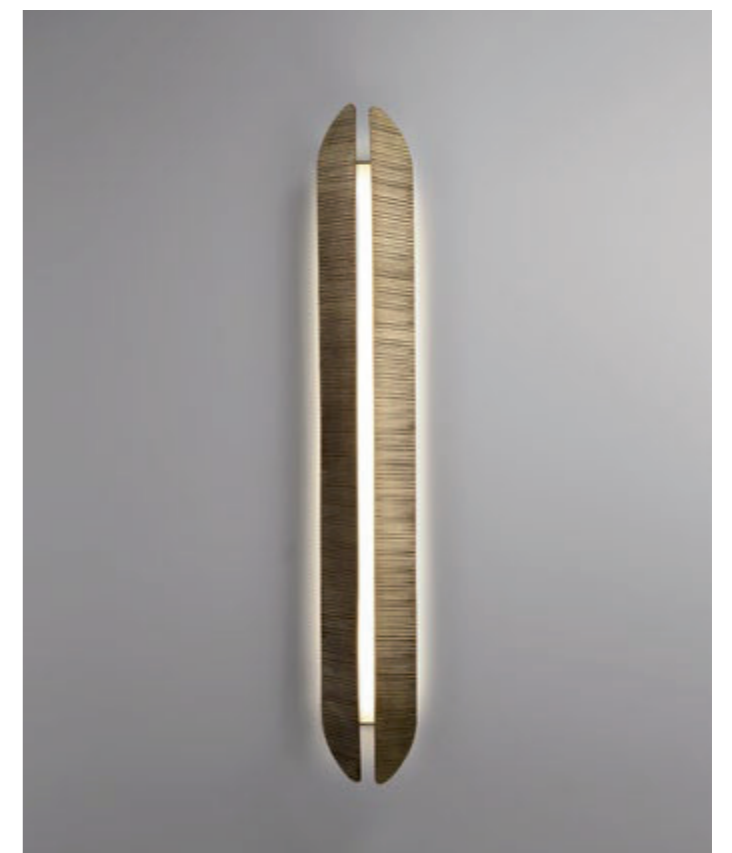
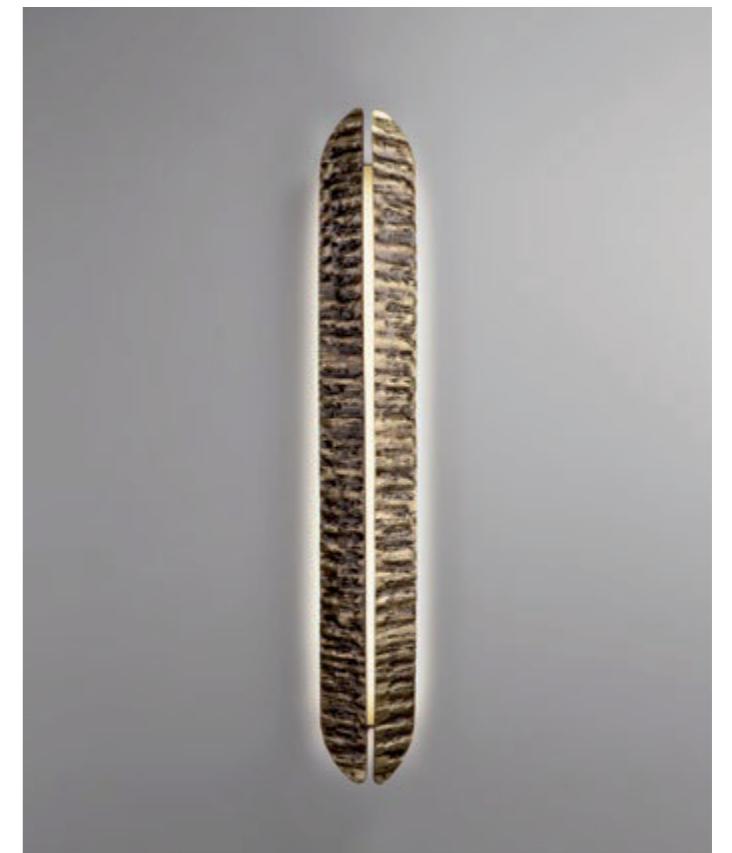



Foliage

DATA SHEET P.374

← ↗
Foliage Lighting DC710/711/712
DeLabré brass F2

LIGHTINGS



DESIGN BY ADELE MARTELLI

Foliage is an ode to the eternal beauty of the passage of time and of the cycle of life as it is transformed and renewed: curves which flutter delicately in the sky as they are carried upon the wind, and which, in their dance, are suspended in almost ethereal purity. This light fitting is made of slightly curved metal elements which encase a light source as they elegantly intersect, suspended on slender electrical cords. Different elements make it possible to create infinite compositions.

Foliage è un omaggio alla bellezza immutabile dello scorrere del tempo e del ciclo della vita che si trasforma e si rinnova: curve che ondeggiavano delicate nel cielo, trasportate dal vento e che nella loro danza restano sospese in una purezza quasi eterea. La lampada è realizzata con elementi di metallo lievemente curvati che racchiudono una fonte luminosa ed elegantemente s'intrecciano, sorretti da sottili cavi di alimentazione. Grazie ai diversi elementi è possibile creare infinite composizioni.

Light&Shade



DATA SHEET P.375

DESIGN BY ADELE MARTELLI

Dawn and sunset are moments loaded with intensity and charm: a flow of light always in transformation, which oscillates in its intensity and colour. Light&Shade immortalises the precise time of the day in which the clear sky is reflected in a calm sea. Available in copper, brass and stainless steel, these large wall sconces conceal their light source, which softly radiates from the circumference to create soft ambient lighting, acting as a decorative element.

Alba e tramonto sono momenti carichi di intensità e fascino: un flusso di luce sempre in trasformazione, che oscilla per intensità e colore. Light&Shade immortala quell'istante preciso del giorno in cui il cielo terso si riflette in un mare calmo. Disponibili in rame, ottone e acciaio queste lampade a parete dalle dimensioni importanti celano la fonte luminosa che viene irradiata con morbidezza dalla circonferenza per creare una luce d'ambiente morbida e al contempo fungere da elemento decorativo.

Light&Shade Lighting DC713
← DeSalt brass M7
↗ DeMarea brass M6

LIGHTINGS

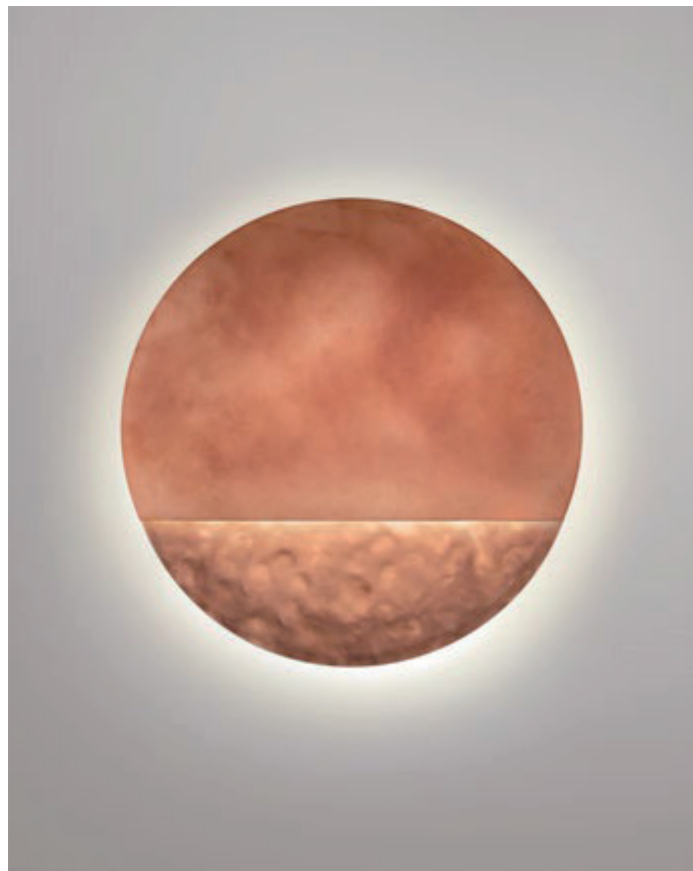
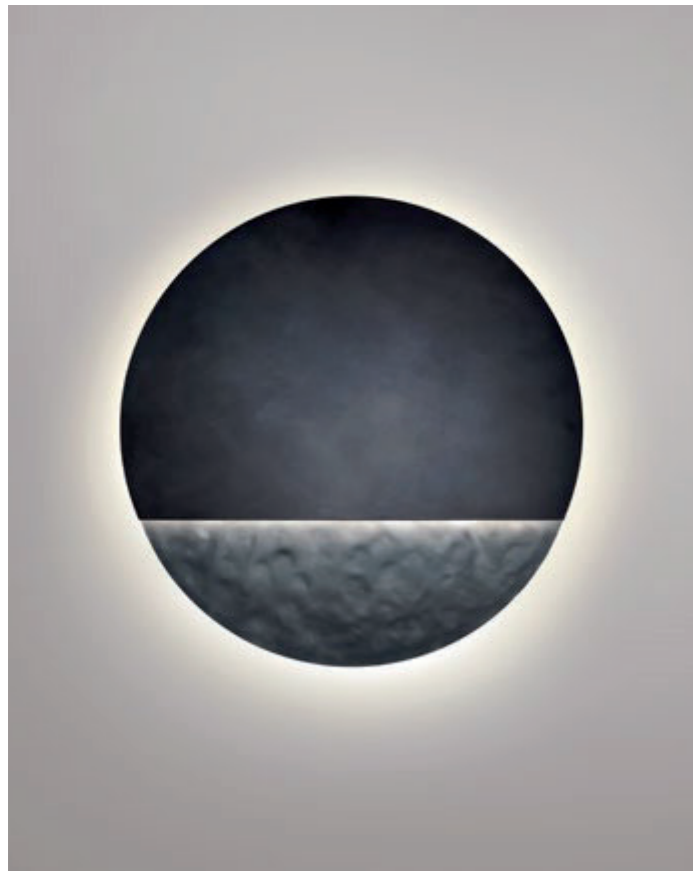

Light&Shade Lighting dc713
DeDeep stainless steel G12
DeLabré copper G5



Light&Shade Lighting dc713
DeSalt M7

Poyagi Frame P.244
DA107

Light&Shade Lighting
DC713-G5

Canneto 234 wall-mounted Console P.6
DC673-M10

Drops Coffee tables P.172
DC663-N3-M10 / DC664-N2-M10 / DC665-N1-M10





Luce Solida

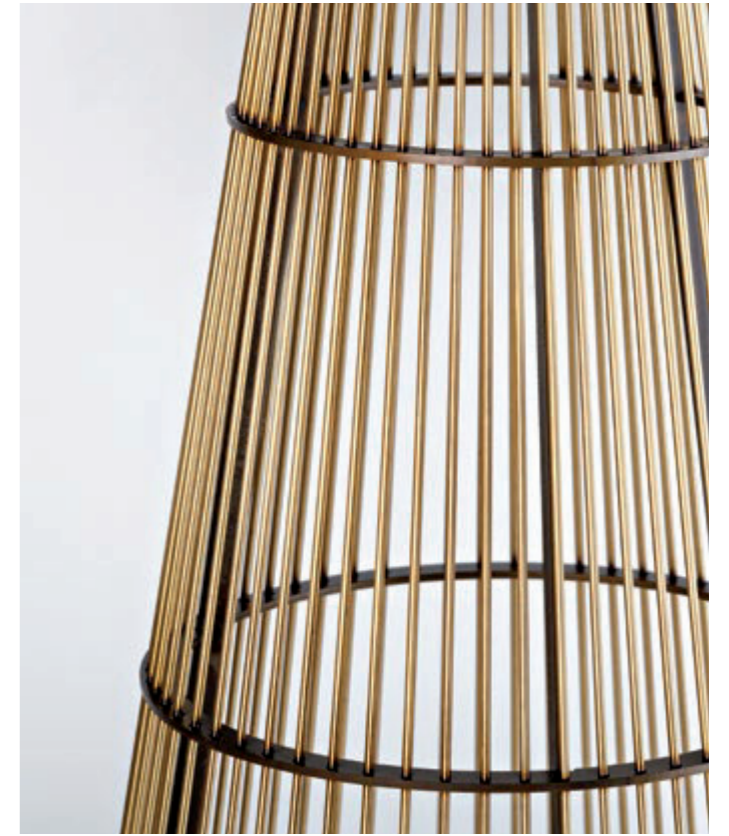

DATA SHEET P.375

DESIGN BY GUMDESIGN

An iron or brass cone forms a sunburst to outline and to expand light, defining its consistency, exploring new formal boundaries. Luce Solida is a lightweight lamp, built around a 'shade' made of small metal rods placed side by side, dematerializing its structure into a series of positive and negative spaces. Rigorous in its graphic mark and innovative for the 'elementary' use of materials, Luce Solida directly illuminates space and amplifies its luminosity thanks to its airy diffusor.

Un cono in ferro od ottone forma una raggiera che delimita ed espande la luce, definendone la consistenza, esplorando un nuovo confine formale. Luce Solida è una lampada leggera, costruita intorno a un diffusore realizzato con piccoli tondini metallici affiancati, che decostruisce la struttura con una serie di vuoti e pieni. Rigorosa nel segno grafico ed innovativa per l'uso "elementare" dei materiali utilizzati, illumina in maniera diretta lo spazio e amplifica l'effetto luminoso grazie all'evanescenza del diffusore.

← ↗
Luce Solida 30 Lighting dc469
DeLabré brass F2

Luce Solida 42 Lighting dc470
DeLabré brass F2



Luce Solida 88 Lighting pc471
DeLabré iron B E5

Luce solida 42 Lighting
DC470-F2

Sunset & Sunrise Coffee tables P192
DC536-OT / DC535-RA





Ribot

DATA SHEET P.375

← ↗
Ribot Lighting DC502
Polished hammered brass G8



DESIGN BY ALESSANDRO MASON

A flowing, sensible presence, delicately balanced. A sculptural object composed of a hand-hammered brass diffuser, metal that still seems to radiate the energy of the tool that shaped it. Light, originating from a LED source, is reflected as if it was liquid. Each reflection evokes the movement of water, while the entire composition seems to vibrate brightly in space.

Una presenza fluida, sensibile, delicatamente posata in equilibrio. Un oggetto-scultura composto da un diffusore in ottone martellato a mano, dove il metallo sembra ancora irradiare energia ai tocchi dello strumento che lo ha plasmato. La luce prodotta da una sorgente a led si rifrange come fosse liquida; ogni riflesso evoca il movimento dell'acqua, mentre l'intera composizione sembra vibrare luminosa nello spazio.

Twist

DATA SHEET P.375-376

Twist suspended Lighting DC687
← Orbitale DeLabré brass G3
↗ Orbitale DeLabré copper G4

LIGHTINGS



DESIGN BY ZANELLATO/BORTOTTO

A two-dimensional metal surface becomes three dimensional thanks to hand-crafted processes: folding, hammering, bending and soldering generate different light diffusers inspired by the complex shapes of conoids, starting from a single outline. Each volume is assigned to a different type of lamps (suspended, table-top), suggesting the ways in which metal offers various interpretations and possibilities. The finishes and the processes used are combined to play with the alternation of brushed and oxidised, reflecting light in unexpected ways from piece to piece.

La superficie in metallo bidimensionale si fa tridimensionale attraverso lavorazioni artigianali: la piegatura, la martellatura, la bombatura, la saldatura generano - a partire dalla medesima sagoma - diversi diffusori ispirati alle forme complesse delle conoidi. Ciascun volume individua delle tipologie di luce - a sospensione, da tavolo - suggerendo come il metallo possa offrire svariate interpretazioni e possibilità. Le finiture, combinate con le lavorazioni, giocano sull'alternanza fra spazzolato e ossidato per riflettere di volta in volta la luce in modo del tutto inaspettato.



↑
Twist table Lighting
DC686-G3

Sculpt 165 Sideboard P.56
DC690-M16





Brame



DATA SHEET P.376

DESIGN BY R&D DE CASTELLI

Slightly oversized proportions and an intentionally asymmetrical border (compared to the reflective surface) define this decorative mirror as it seduces and attracts. But the sense of yearning is transformed soon into an aura of intimacy for the person reflected in it. The bold metal frame envelops as it inspires introspection, suggested by its concavity, its many tones of oxidation, and the juxtaposed reflections that give rise to different potential interpretations.

La forma e il volume esasperati, intenzionalmente asimmetrici rispetto alla superficie riflettente, definiscono uno specchio decorativo che seduce e attira. Ma la bramosia si trasforma ben presto in un'aura di intimità per chi si specchia. L'importante cornice in metallo avvolge e invita all'introspezione suggerita dalla concavità, dai molteplici toni di ossidazione e dai giochi di riflessi che stimolano diverse possibilità di interpretazione. Possibilità di retro illuminazione a Led.

Brame Mirror DC671L
← DeDeep stainless steel G12
↗ Orbitale DeLabré brass G3



Frame



DATA SHEET P.376

DESIGN BY ANTONELLA TESEI

Frame is a mirror wrapped in a deep metal frame. Drawing close is unavoidable for those who look in the mirror, enabling them to observe their image from closer up. Ever the provocateur, Frame doesn't allow us to settle for the surface, advising, in some way, introspection and awareness. Almost as if to convey the impermanence of the image reflected, this object is meant to be affixed to the wall in an inclined position.

Frame è uno specchio racchiuso in una cornice in metallo molto profonda. Inevitabile per chi si specchia è avvicinarsi al vetro riflettente, per osservare l'immagine più da vicino. Frame è un oggetto provocatorio, che non permette a chi si guarda di accontentarsi della superficie, consigliando in un certo modo introspezione e consapevolezza. Viene fissato a parete in posizione inclinata, quasi a voler comunicare la provvisorietà dell'immagine riflessa.

←
Frame 60 Mirror DC480
Orbitale DeLabré brass G3

↗
Frame 110 Mirror DC482
Orbitale DeLabré stainless steel G2

Frame 60 Mirror
DC480-G3

Marea Cabinet P.34
DC605-M4

Placas 60 Coffee table P.184
DC491-G5

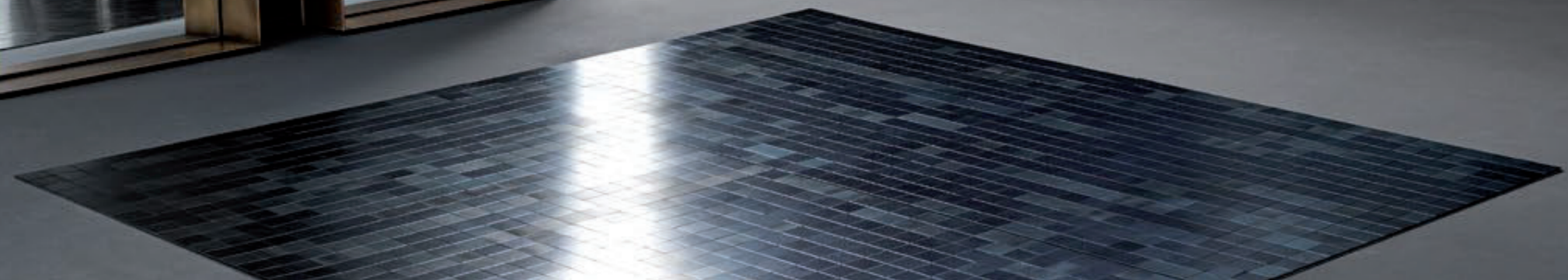

Riflesso



Riflesso 120 Mirror
DC608-1200-G3

Marea 190 Sideboard P.34
DC606-M5

Syro XL 88 Coffee table P.198
DC630-OT-H7



DATA SHEET P.376

DESIGN BY R&D DE CASTELLI

A collection of wall-mounted mirrors that celebrates the virtues of simplicity. Characterized by the essential, complete form of the circle, Riflesso is distinguished by the thick brass and stainless steel frames that outline its reflective surfaces, delimiting rings of different sizes to hang alone or in groups. Versatile pieces perfectly suited to the contemporary nature of domestic living, these decorative items combine the richness of De Castelli finishes with the extreme essentialism of its shapes.

Una collezione di specchi da parete che celebra la virtù della semplicità. Caratterizzata dalla forma elementare e compiuta del cerchio, si distingue per le spesse cornici di ottone e acciaio che delimitano le superfici riflettenti, disegnando anelli di diverse dimensioni da appendere soli o in gruppo. Sono accessori d'arredo che combinano la ricchezza delle finiture De Castelli con l'essenzialità estrema delle forme, pezzi versatili perfettamente calati nella contemporaneità del vivere domestico.

➤
Riflesso 45 Mirror DC608-450
Orbitale DeLabré stainless steel G2

Riflesso 70 Mirror DC608-700
Orbitale DeLabré brass G3

Riflesso 90 Mirror DC608-900
Orbitale DeLabré brass G3

MIRRORS

Syro Mirror



DATA SHEET P.377

DESIGN BY EMILIO NANNI

The Syro Mirror echoes the organic silhouettes of the entire Syro collection, translating them into mirrored surfaces that, surrounded by thick stainless steel and brass frames, mimic the natural outlines of petals. In a mix of chromatic effects obtained from various metal treatments, these multifaceted shapes can be arranged as desired, on their own or one next to another. The organic nature of the collection is thus amplified, revealing the multiple ways they can be combined on the wall, with surprisingly dramatic results.

Syro Mirror riprende le forme organiche della collezione omonima e le traduce in superfici specchianti che, inserite nelle cornici in acciaio e ottone di forte spessore, mimano le sagome naturali dei petali. Tratti caratterizzanti sono il mix di effetti cromatici ottenuti dai vari trattamenti del metallo e la poliedricità delle forme, collocabili a piacimento da sole o una vicina all'altra: l'insieme amplifica l'organicità della collezione svelando molteplici possibilità di combinazione a parete con sorprendenti effetti scenografici.

↗
Syro 56 Mirror DC620
Orbitale DeLabré stainless steel G2

Syro 76 Mirror DC619
Orbitale DeLabré brass G3

Syro 80 Mirror DC618
Orbitale DeLabré brass G3

MIRRORS

Arazzi Re

DESIGN BY GUMDESIGN



DA103
Decorative square brass tiles with custom DeErosion finishing.
Stainless steel frame with brass finishing.
W. 180 D. 4,5 H. 210 cm / 107 kg

Arazzi Regina

DESIGN BY GUMDESIGN



DA104
Decorative square brass tiles with custom DeErosion finishing.
Stainless steel frame with brass finishing.
W. 180 D. 4,5 H. 210 cm / 107 kg

Erosion

DESIGN BY R&D DE CASTELLI



DA105
Decorative square brass and copper tiles with a mix of DeErosion finishing.
Stainless steel frame with brass finishing.

W. 150 D. 4,5 H. 210 cm / 66 kg

Hexagon

DESIGN BY R&D DE CASTELLI



DA108
Decorative hexagonal copper tiles with DeErosion and brushed finishes.
Stainless steel frame with copper finishing.

W. 190 D. 4,5 H. 210 cm / 107 kg

Poyagi

DESIGN BY ZANELLATO/BORTOTTO

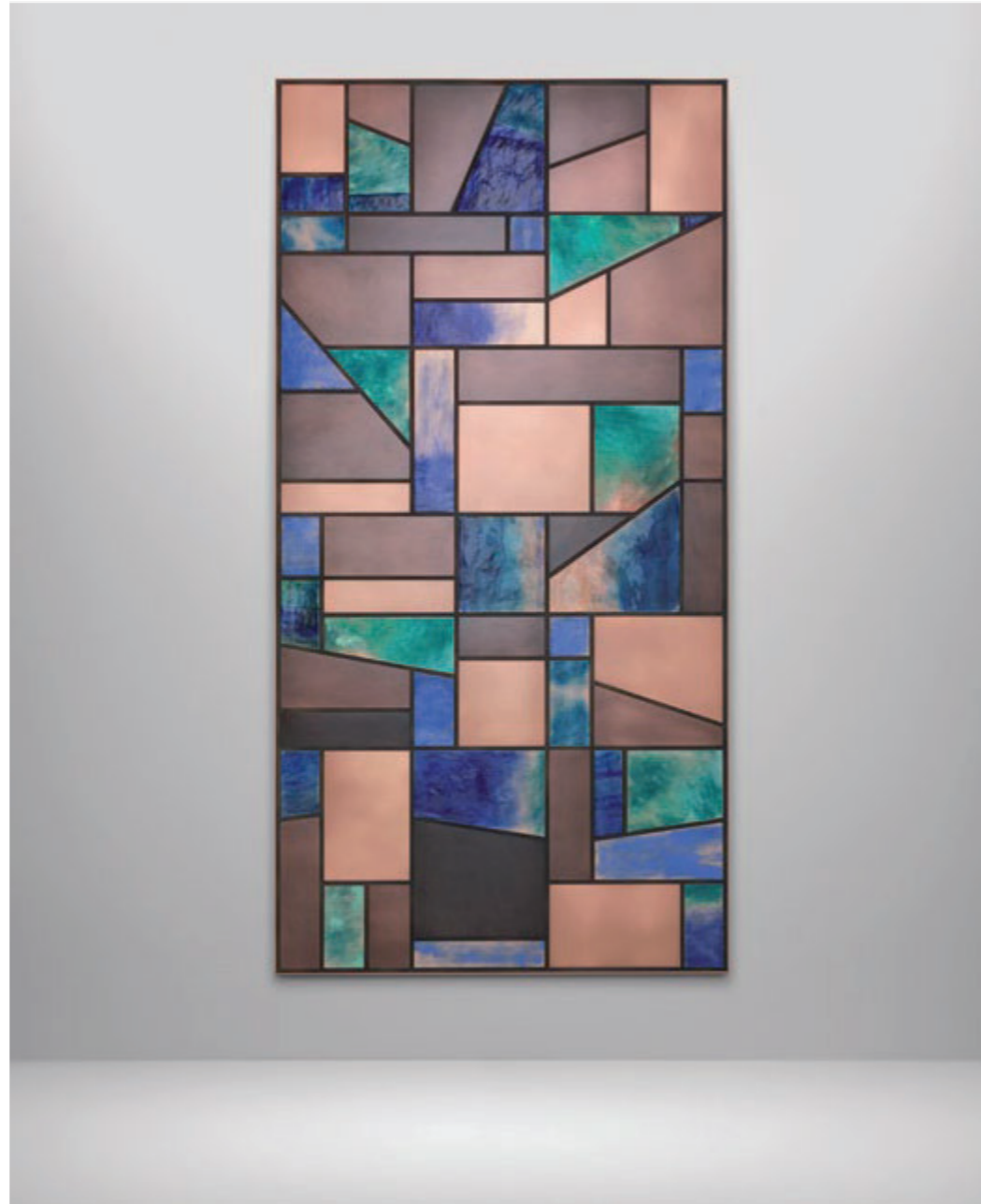

DA107

Patchwork of copper tiles of different shapes and sizes with a mix of oxidation and enamel finishes.
Stainless steel frame with copper finishing.

W. 100 D. 4,5 H. 200 cm / 60 kg

Solar

DESIGN BY ZANELLATO/BORTOTTO



DA106

DeMarea brass decorative panel with DeDeep stainless steel insert.
Stainless steel frame with brass finishing.

W. 122 D. 4,5 H. 170 cm / 50 kg

Wild Geometries

DESIGN BY ELENA SALMISTRARO



DA102
Decorative square and rectangular brass tiles with custom DeErosion finishing.
Stainless steel frame with brass finishing.
W. 180 D. 4,5 H. 210 cm / 107 kg

Yoko 01

DESIGN BY LEONARDO SONNOLI

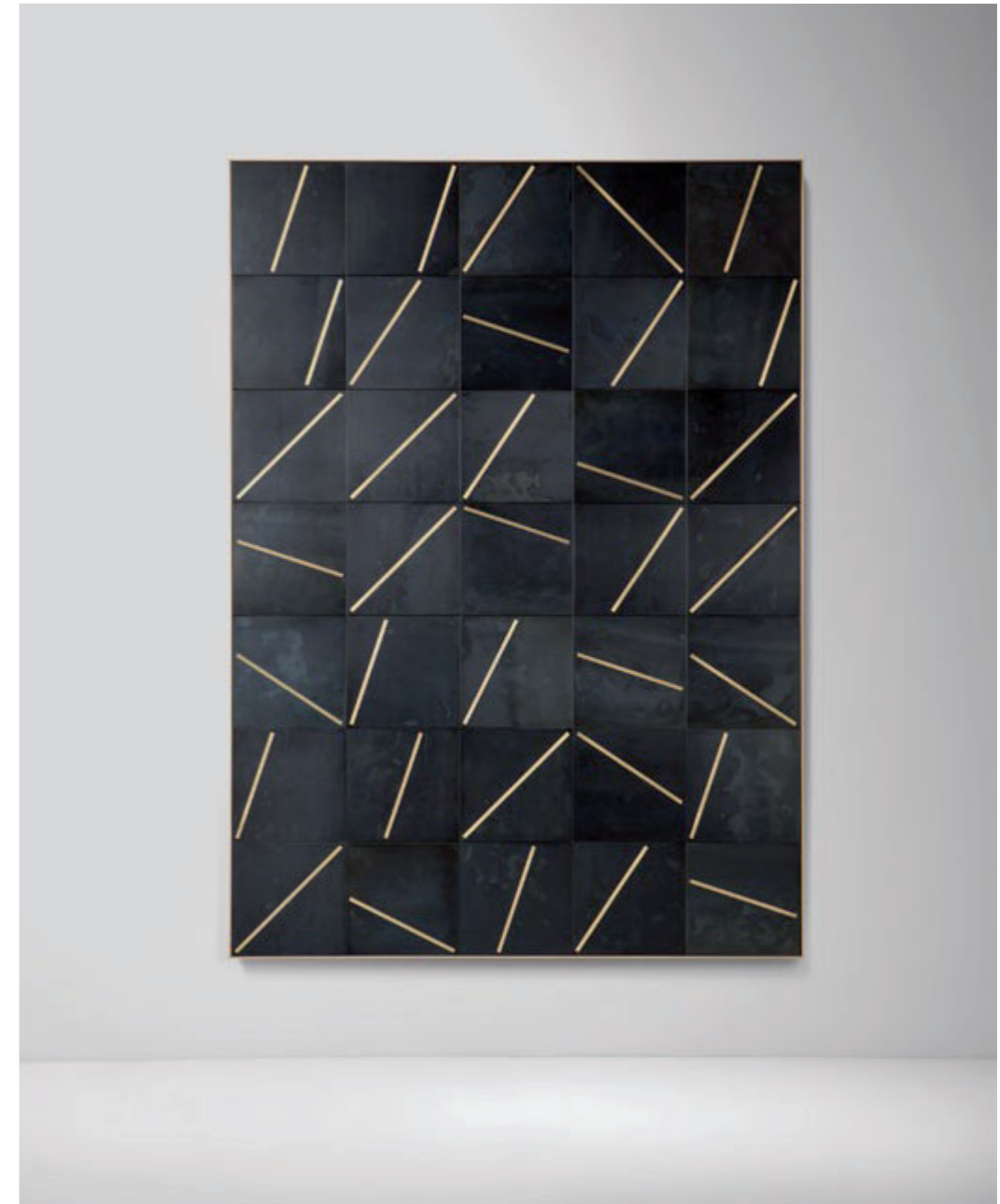

DA100
Decorative square tiles in DeDeep stainless steel with brushed brass inserts.
Stainless steel frame with brass finishing.
W. 150 D. 4,5 H. 210 cm / 90 kg

Yoko 02

DESIGN BY LEONARDO SONNOLI

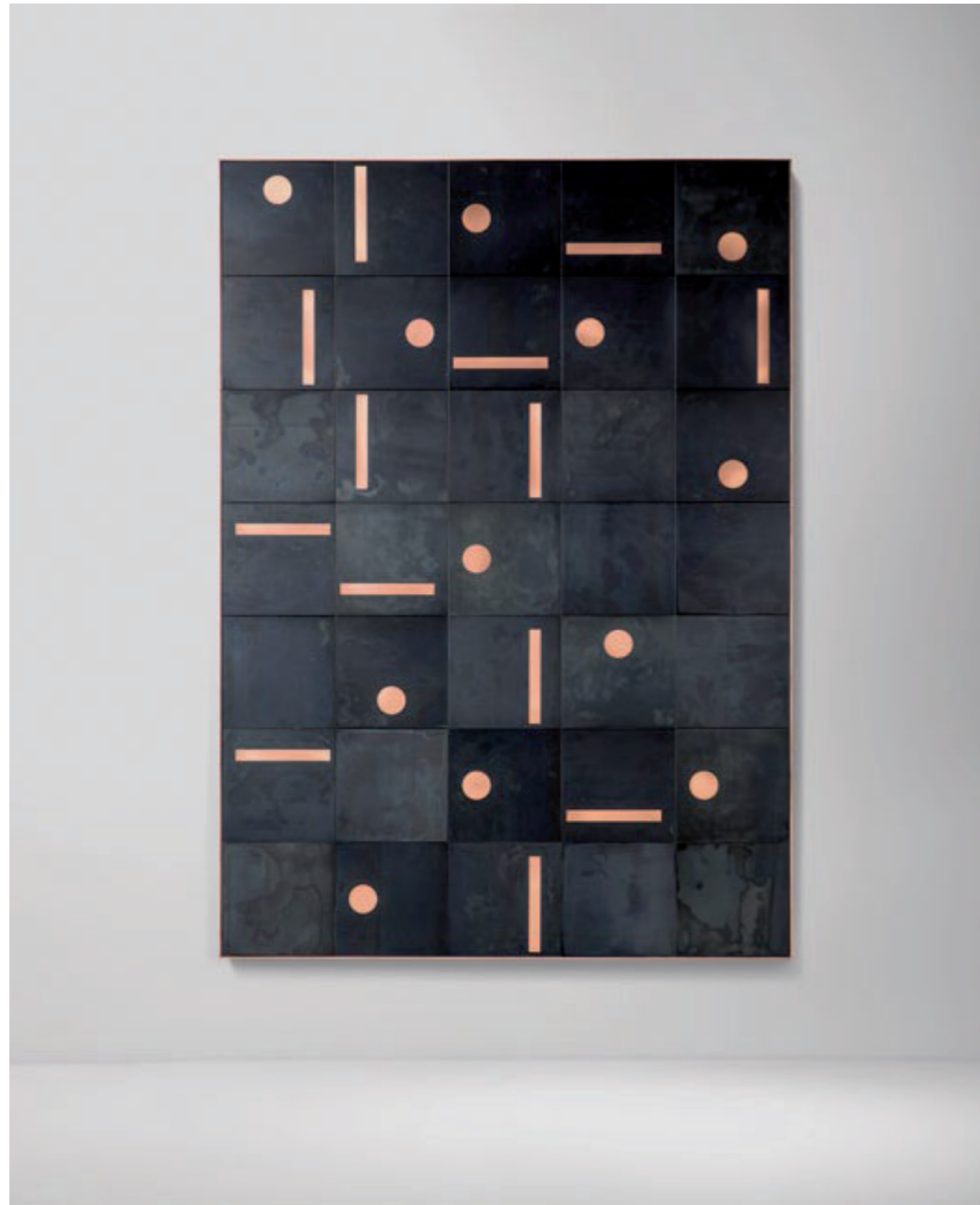

DA101
Decorative square tiles in DeDeep stainless steel with brushed copper inserts.
Stainless steel frame with brass finishing.

W. 150 D. 4,5 H. 210 cm / 90 kg

Your Signature Frame
CUSTOM-G5



A-Modulo

DATA SHEET P.377

DESIGN BY R&D DE CASTELLI

Simple doesn't mean easy. Only rigorous studies in simplicity result in shapes able to fuse with plants, in harmony with the landscape. A-Modulo planter boxes furnish gardens, parks and terraces, transforming into easily-positioned dividers, impeccably decorating external spaces thanks to carefully-designed proportions and select materials.

Semplice non significa facile. Solo dalla rigorosa ricerca della semplicità, si generano forme in grado di fondersi con il vegetale in armonia con il paesaggio: A-Modulo propone fioriere che arredano giardini, parchi e terrazze, che si trasformano in elementi divisori facilmente posizionabili, che decorano impeccabilmente gli ambienti esterni grazie all'attento studio delle proporzioni e la particolare attenzione ai materiali.



A-Modulo 40 Pot
Bronzed DeMastral stainless steel D3

Cohiba

DATA SHEET P.377

DESIGN BY R&D DE CASTELLI

A pure cylindrical shape comes in De Castelli metals and finishes for a series of cachepots with abounding stage presence. In their linear simplicity, these objects become landmarks for home, not just accessories but also cardinal points that orient the space. In different heights and diameters, they stand alone or make up multi-faceted sets.

La forma pura del cilindro viene declinata nei metalli e nelle finiture De Castelli per una serie di cachepot di grande presenza scenica. Nella loro lineare semplicità, sono oggetti che divengono landmark di un paesaggio domestico, non solo accessori ma punti cardinali che orientano lo spazio. Di diverse altezze e diametri, vivono da soli o compongono insiemi sfaccettati.



Cohiba Large 57 Pot DC40
Corten D6

Cohiba Large 82 Pot DC41
Bronzed DeMastral
stainless steel D3

Cohiba Slim 122 Pot DC43
Bronzed DeMastral
stainless steel D3

Cohiba Slim 82 Pot DC42
Polished stainless steel D2

Cohiba Slim 142 Pot DC44
Polished stainless steel D2

Conique

DATA SHEET P.378

DESIGN BY FILIPPO PISAN

With Conique, metal imitates volcanic rock to erupt with plant formations and to replace the destructive power of magma with the creative force of flora. Designed for an indoor and an outdoor use, these cachepots are defined by the contrasting dimensions of the collection: the diameter of the ample base is the same in all three heights, creating a choreographed dance of combinations and compositions.

In Conique, il metallo mima la roccia vulcanica per farne uscire formazioni vegetali e sostituire alla forza distruttrice del magma la forza creatrice della natura. Concepiti per indoor ed outdoor, i cachepot si caratterizzano per il forte contrasto dimensionale della collezione: il diametro dell'ampia base, infatti, rimane inalterato in tutte e tre le altezze in cui sono proposti, permettendo un coreografico gioco di abbinamenti e composizioni.



Conique 27 Pot DC408
Corten D6

Conique 62 Pot DC407
Corten D6

Conique 102 Pot DC406
Corten D6

Cube

DATA SHEET P.378

DESIGN BY R&D DE CASTELLI

Cube is a line of containers with absolute formal sobriety, where the completeness of the cube is combined with different finishes abounding in personality. Rigor and creative impetus are fused in a timeless composition that blends with the open space around it.

Cube è una linea di contenitori di assoluta sobrietà formale, dove alla proporzione compiuta del cubo si abbinano diverse tipologie di finitura dalla grande personalità. Rigore e slancio creativo si fondono in una composizione senza tempo che si fonde con lo spazio aperto in cui viene collocata.



Cube 84 Pot DC111
Corten D6

Dafne & Demetra

DATA SHEET P.378

DESIGN BY LUDOVICA+ROBERTO PALOMBA

Partition, lamp or planter, these bright objects can decorate indoor and outdoor spaces. Three different functions come together in a single element characterized by a refined geometric pattern, filtering light. The solid, compact base, which can be anchored to the ground, is juxtaposed with an upper section where a pattern covers and lightens the structure, diffusing light and welcoming its green soul.

Divisorio, lampada o fioriera, è un oggetto luminoso che arreda l'interior e l'outdoor. Tre diverse funzioni che si compenetrano in un unico elemento caratterizzato dal deciso pattern grafico che definisce la superficie e incide sulla luce. Alla base solida e compatta, che può essere fissata a terra, si contrappone una sezione superiore dove il disegno si rincorre e alleggerisce la struttura, permettendo la diffusione della luce e accogliendo la sua anima verde.



←
Dafne 210 Pot DC194
Bronzed DeMastral stainless steel D3

→
Demetra 210 Pot DC207
RAL 9010 lacquered stainless steel D8

Dafne 210 Pot DC194
RAL 9010 lacquered stainless steel D8

Delta & Omega

DATA SHEET P.379

DESIGN BY ALBINO CELATO

Essential terracotta vases become precious creations in metal with large-scale proportions, the star of any space with clear personality. Perfectly functional for greenery, thanks to the plastic container and the included saucer, models in the Delta and Omega series are suitable for multiple combinations in terms of colours and sizes.

Il comune vaso di terracotta diviene una preziosa creazione in metallo di grandi proporzioni, protagonista dello spazio con evidente personalità. Perfettamente funzionali all'alloggiamento del verde, grazie al contenitore in plastica e al sottovaso di cui sono provvisti, i modelli della serie Delta e Omega si prestano per molteplici combinazioni sia di cromie che di dimensioni.



Omega 77 Pot DC023
Corten D6

Delta 117 Pot DC086
Corten D6

Delta 140 Pot DC085
Corten D6

Narnya

DATA SHEET P.379

DESIGN BY R&D DE CASTELLI

A cachepot in ascending heights, all with one single diameter. Five different proportions to explore a shape generally associated with vases, to be positioned freely or anchored to the ground. The towering lines of the large-scale versions are naturally imposing, becoming a building within a building, defining the space and its paths. Destined both for an indoor and an outdoor use, Narnya brings unmistakable De Castelli finishes to domestic spaces or, in the lacquered version, blends in with its surroundings.

Un cachepot declinato ad altezze scalari, ma con un unico diametro. Cinque diverse proporzioni per esplorare una forma tipicamente associata al vaso da fiori, da posizionare liberamente o da fissare a terra. La linea svettante si impone naturalmente nelle grandi dimensioni, un'architettura nell'architettura, definendo lo spazio e i percorsi. Destinato sia all'indoor che all'outdoor, può portare nello spazio domestico le inconfondibili finiture De Castelli o può mimetizzarsi con l'ambiente nella versione laccata.



Narnya 100 Pot DC105
Polished stainless steel D2

Narnya 120 Pot DC104
Polished stainless steel D2

Narnya 140 Pot DC103
Polished stainless steel D2

Phil

DATA SHEET P.379

DESIGN BY JOHANNES KLEIN

Arising from the union of DeLabré stainless steel and shiny steel, Phil is a series of cachepots with simple lines rendered complex thanks to its unique combination of contrasting materials and finishes. Highlighting the sensory nature of its surfaces in an interplay of shiny and matt, light and dark, Phil comes in one single proportion and three variations, characterized by the triumph of one metal or another.

Dall'incontro tra l'acciaio DeLabré e l'acciaio lucido nasce Phil, una serie di cachepot dalle linee estremamente semplici, rese complesse dall'abbinamento di materiali e finiture contrastanti, che mettono in evidenza la sensorialità delle superfici. In una rincorsa tra lucido e opaco, luminoso e oscuro, Phil si offre un'unica proporzione e tre varianti, caratterizzate dal prevalere di uno o dell'altro metallo.



Phil 44 Pot DC484
DeLabré B E5 and polished D2 stainless steel

Phil 62 Pot DC485
DeLabré B E5 and polished D2 stainless steel

Phil 77 Pot DC486
DeLabré B E5 and polished D2 stainless steel

Riviera Pots

DATA SHEET P.380

DESIGN BY ALDO CIBIC

"I've always been drawn to nature as it manifests its strength in unexpected contexts". With this, Aldo Cibic built a miniature natural landscape, poetically made of structures, containers and objects to house small gardens, both indoors and outdoors. With a minimal, simple design and a thin, barely-there frame, the lightness of the lines converges to exalt the expressiveness of the metals and the sensory nature of their surfaces.

"Sono sempre stato attratto dalla natura che manifesta la sua forza in contesti inaspettati"; così Aldo Cibic costruisce un paesaggio in miniatura, lavorando su una poetica fatta di strutture, contenitori e oggetti in cui alloggiare piccoli giardini, pensati per l'interno e per l'esterno. Minimo e semplice il disegno, sottili gli spessori della struttura che quasi sparisce: la leggerezza delle linee confluisce nell'esaltazione dell'espressività dei metalli e dalla sensorialità delle superfici.



Riviera 50-3 Pot DC165
Bronzed DeMastral
stainless steel D3

Riviera 90-3 Pot DC162
Bronzed DeMastral
stainless steel D3

Riviera 90-1 Pot DC161
RAL 9010 lacquered
stainless steel D8

Riviera 60-1 Pot DC167
Bronzed DeMastral
stainless steel D3

Rocco & Lolita

DATA SHEET P.380

DESIGN BY STEFANO DUSSIN

Clear examples of the preciousness of metal in all its variations, Rocco and Lolita are decorative elements characterized by pure and essential lines. Two structures that play with light and shadow, creating unexpected effects on surfaces. Their silhouettes draw elegant curves in a complementary and harmonious ensemble, creating an ideal balance.

Espressioni sculturali della nobiltà del metallo in tutte le sue declinazioni, Rocco e Lolita sono elementi decorativi caratterizzati dalla grande purezza delle forme e dall'essenzialità delle linee. Le loro sagome sfaccettate ampliano il gioco dei chiaroscuri e aprono alle possibilità offerte dalla rifrazione della luce sulla superficie. Le diverse silhouette disegnano sinuose curve nello spazio secondo un andamento complementare e armonico, in un ideale equilibrio di volumi.



Rocco 147 Pot DC075
Orbitale DeLabré brass G3

Lolita 140 Pot DC072
Orbitale DeLabré brass G3

Screen-Pot

DATA SHEET P.380

DESIGN BY FRANCOIS CLERC

Screen-Pot is a contemporary version of the classic flower pot with a trellis for climbing vines. Its design was inspired by the shapes of nature itself: like a leaf among leaves, the trellis softly closes on itself to embrace the plant. It can also act as a partition to create mobile plant dividers, natural screens that offer privacy and protection from the wind.

Screen-Pot è la rivisitazione in chiave contemporanea della classica fioriera con griglia per piante rampicanti. Il disegno si ispira alle forme della natura: come una foglia tra le foglie, la griglia si richiude morbidamente su sé stessa per accogliere il verde. Può assolvere anche la funzione di divisorio e creare schermature vegetali mobili, separare naturali che offrono privacy e proteggono dal vento.



Screen-pot 1 Plant DC402
Corten D6

Screen-pot 2 Plants DC403
Bronzed DeMaistral stainless steel D3

Shimla & Jaipur

DATA SHEET P.380

DESIGN BY STEFANO DUSSIN

Next stop, India: these oriental-style decorative vases are sculptural elements with generous and simultaneously slim shapes. In addition to classic finishes, like Corten and bronzed stainless steel, they are sumptuous in a spectacular gold leaf finishing, like wonderful vessels worthy of a Maharaja's beautiful home.

Destinazione India: questi vasi decorativi di immediato sapore orientale sono elementi scultorei, dalle forme generose ed esili al tempo stesso. Oltre alle finiture più classiche, come il corten e l'acciaio brunito, si offrono sontuosi nella spettacolare finitura a foglia d'oro, come recipienti meravigliosi degni delle più belle dimore dei maharaja.



Jaipur 183 Pot DC082
Bronzed DeMastral stainless steel D3

Shimla 150 Pot DC113
Orbitale DeLabré brass G3

Jaipur 150 Pot DC083
Bronzed DeMastral stainless steel D3

Tristan & Isotte

DATA SHEET P.381

DESIGN BY STEFANO DUSSIN

Metal is unabashedly confirmed in these large, sinuous sculptures. Complementary forms are emphasized by unique hues and by the precious gold leaf applied to their surfaces. In an interplay of positive and negative spaces, the two figures stand out in anthropomorphic shapes defined by light and shadow, where the finish emphasizes far-away inspirations and evokes the ancient arts of past eras.

Il metallo trova la sua affermazione più completa in queste grandi sculture sinuose le cui forme complementari sono enfatizzate dalle singolari cromie e dalla preziosa foglia d'oro applicata in superficie. In un gioco di pieni e vuoti, le due figure si stagliano in forme antropomorfe delineate dalla luce e dall'ombra, dove la finitura enfatizza l'ispirazione etnica ed evoca l'arte antica di ere passate.



Tristan Pot DC099
Bronzed DeMastral stainless steel D3

Isotte Pot DC098
Bronzed DeMastral stainless steel D3

Cottage N.1

WALLPAPER DESIGN AWARDS, 2012
HONORABLE MENTION ADI COMPASSO D'ORO AWARD, 2014

DATA SHEET P.381

DESIGN BY FILIPPO PISAN

In a revisitation of the classic garden shed that emphasizes the characteristics of its materials, underlined by a minimalist design, an external corten steel 'suit of armour' frames natural spruce facades. The result is a multifunctional space that can be transformed into a beachside hut, mini garage for two-wheeled modes of transport, a nook for meditative getaways, or a micro-workshop for DIY projects. Accessorized with an automatic lighting system that activates once the door opens, Cottage n. 1 also comes with an internal ventilation system thanks to the raised wooden slatted floor and the small perforations in the wall.

Una rivisitazione della classica casetta-ripostiglio da giardino, che enfatizza le caratteristiche dei materiali costruttivi, sottolineate dal disegno minimale. Una "corazza" esterna in acciaio corten incornicia le facciate in legno di abete naturale, creando uno spazio multifunzionale che si trasforma in capanna balneare, mini garage per le due ruote, nicchia pensatoio per fughe meditative, micro officina per il fai-da-te. Accessoriata con un dispositivo di illuminazione automatica che si attiva all'apertura della porta, è provvista di un sistema di aerazione interna, grazie al pavimento rialzato in doghe in legno e ai forellini ricavati sulla parete.

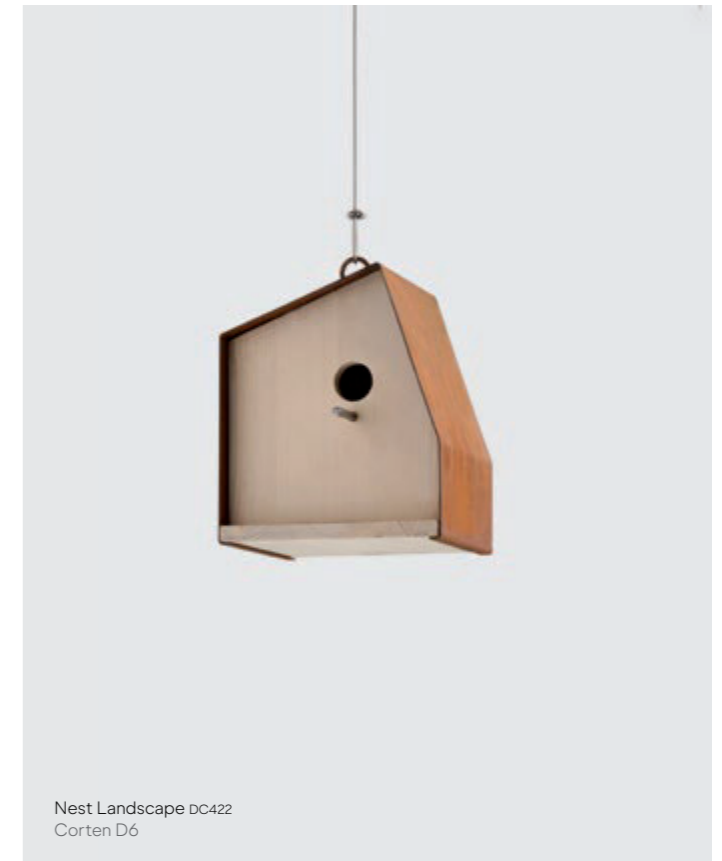

Cottage N°1 Landscape DC420
Corten D6

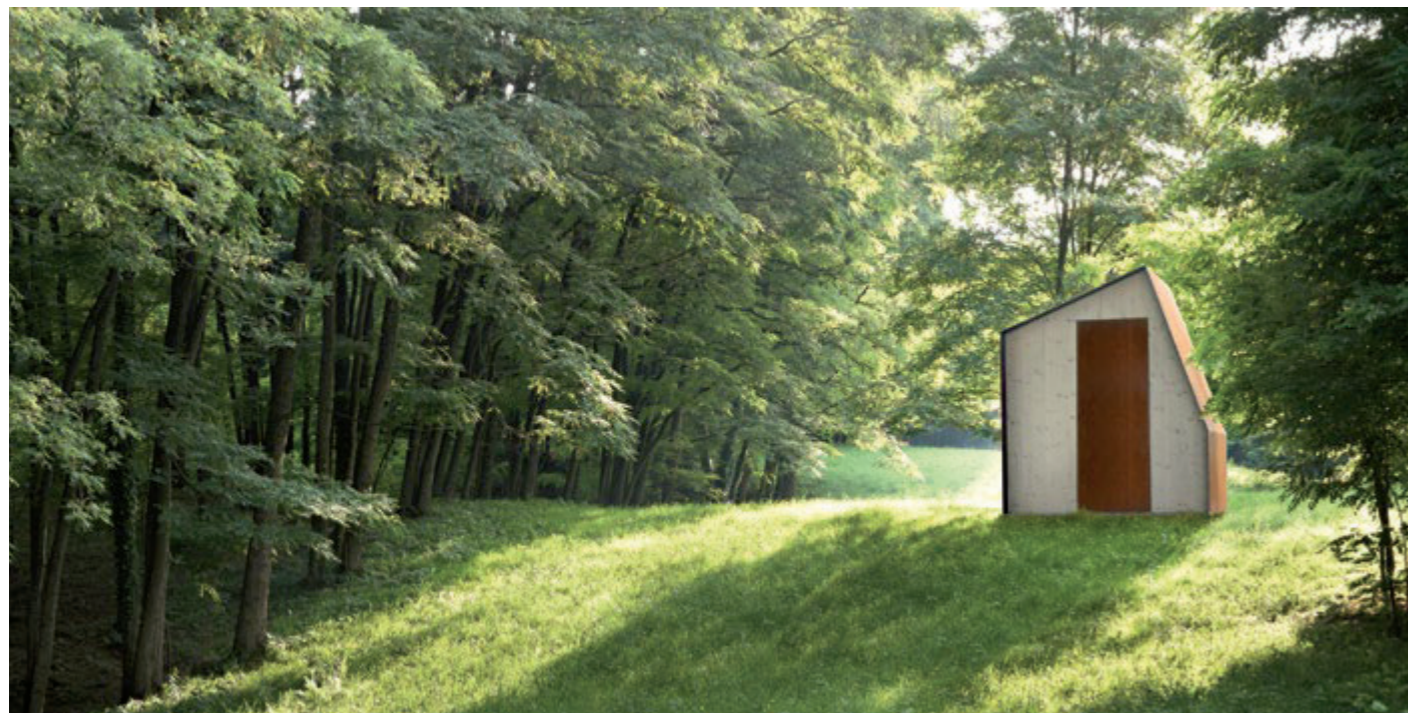

Dog House N.1

DESIGN BY FILIPPO PISAN

Dog House n°1 reinvents homes for our furry friends. Created as a version of Cottage n°1, it offers a conceptual revisitation of traditional kennels, focusing on the intrinsic characteristics of the building materials, which lend functionality and also pleasing aesthetics to be shared with man's best friend.

Dog House n°1 reinventa la casa degli amici a quattro zampe: nata come declinazione del Cottage n°1, propone una rivisitazione concettuale della tradizionale cuccia, concentrando sulle caratteristiche intrinseche dei materiali costruttivi, di cui emerge non solo la funzionalità, ma anche la piacevolezza estetica da condividere con i nostri migliori amici.

DATA SHEET P.381

Nest House N.1

DESIGN BY FILIPPO PISAN

Our care for the environment around us can also be seen in the attention paid to our small friends in the animal kingdom. A small birdhouse can set the stage, with a structure that's both soaring and solid, nest and refuge - a secret port to hang among the trees or the outside walls of a house. Waking up to nature's morning chorus has never been better.

L'attenzione per l'ambiente circostante passa anche dalla cura dedicata ai piccoli amici del mondo animale. Ne è protagonista la casetta per gli uccelli, che diventa architettura volante e solida, nido e rifugio, porto segreto da appendere tra gli alberi o ai muri esterni della casa. Svegliarsi al cinguettio mattutino non è mai stato così piacevole.

DATA SHEET P.381

Tiles
268 Cipher
272 DeErosion
276 Forma
284 Yoko

Mosaics
288 Copycat
294 Diamond 30
298 Losanga
302 Square 30
306 Square 50

Decorative
310 3D Wall
314 Circle Wall
318 DecoDe
322 Vertical Green

Cladding solutions
326 Boiserie & Scomposta
336 Canneté
340 Plissé
344 Vela



Surfaces



Cipher

DIMENSIONS

 7 x 14 cm

THICKNESS

 2 mm

WEIGHT

 17-17,8 kg/m²

USAGE

Wall, Indoor

DATA SHEET P.383

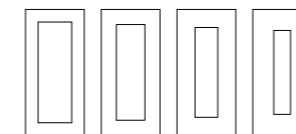

DS108-KIT

 CIPHER DS108-KIT
DeErosion on brass OT
DeErosion on copper RA

TILES

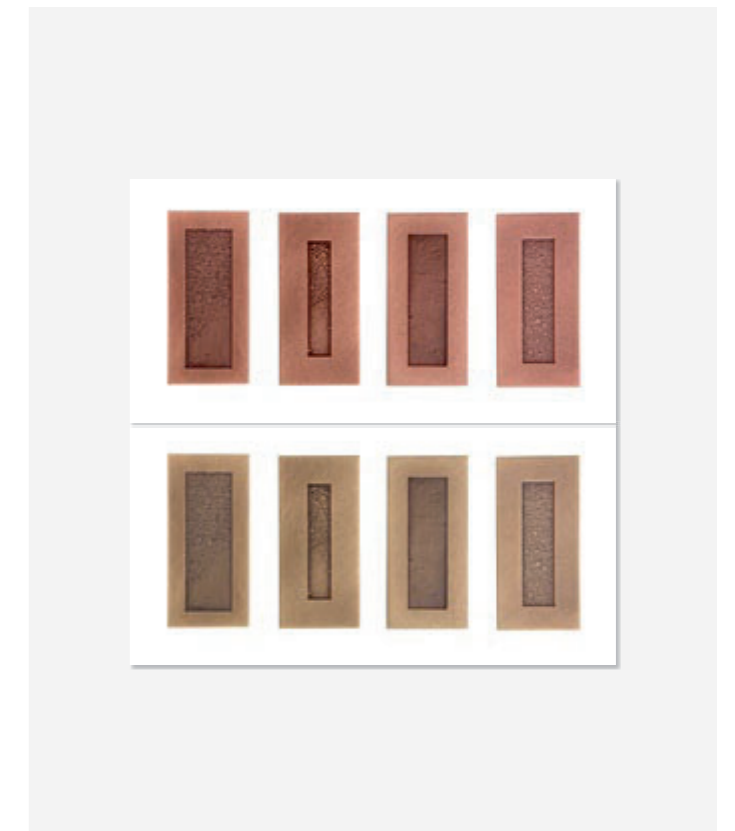

DESIGN BY FRANCESCO FORCELLINI

A modular system with a solid yet dynamic appearance, halfway between rigour and randomness. Starting out from four rectangular formats, each characterised by a differently-sized rectangle with an eroded pattern within it, Cipher creates surfaces of great complexity and detail by employing a very simple code based on a minimum number of elements. The relationship between order and randomness can be observed across the entire product range: both in the micro, where each module has a unique, constantly varying finishing, and in the macro, where the random repetition of the elements occurs within a precise grid with staggered lines.

Un sistema modulare dall'aspetto solido e al tempo stesso dinamico, a metà tra rigore e casualità. A partire da quattro formati rettangolari, ognuno dei quali caratterizzato da un rettangolo di diversa dimensione eroso al suo interno, Cipher crea superfici di elevata complessità e dettaglio grazie a un codice molto semplice basato su un numero minimo di elementi. Il rapporto tra ordine e caso è presente trasversalmente nel prodotto: sia nel micro, dove ogni modulo ha una finitura unica mai uguale a sé stessa, sia nel macro, dove la ripetizione casuale avviene in realtà all'interno di una griglia precisa a linee sfalsate.



Cipher Tile
DS108-KIT-RA

Loom Sofa P.142
DC652-M9

Loom Pouf P.142
DC653-M9



Cipher Tile
DS-108-KIT-OT

Luce Solida 30 Lighting P.220
DC469-F2

DeErosion

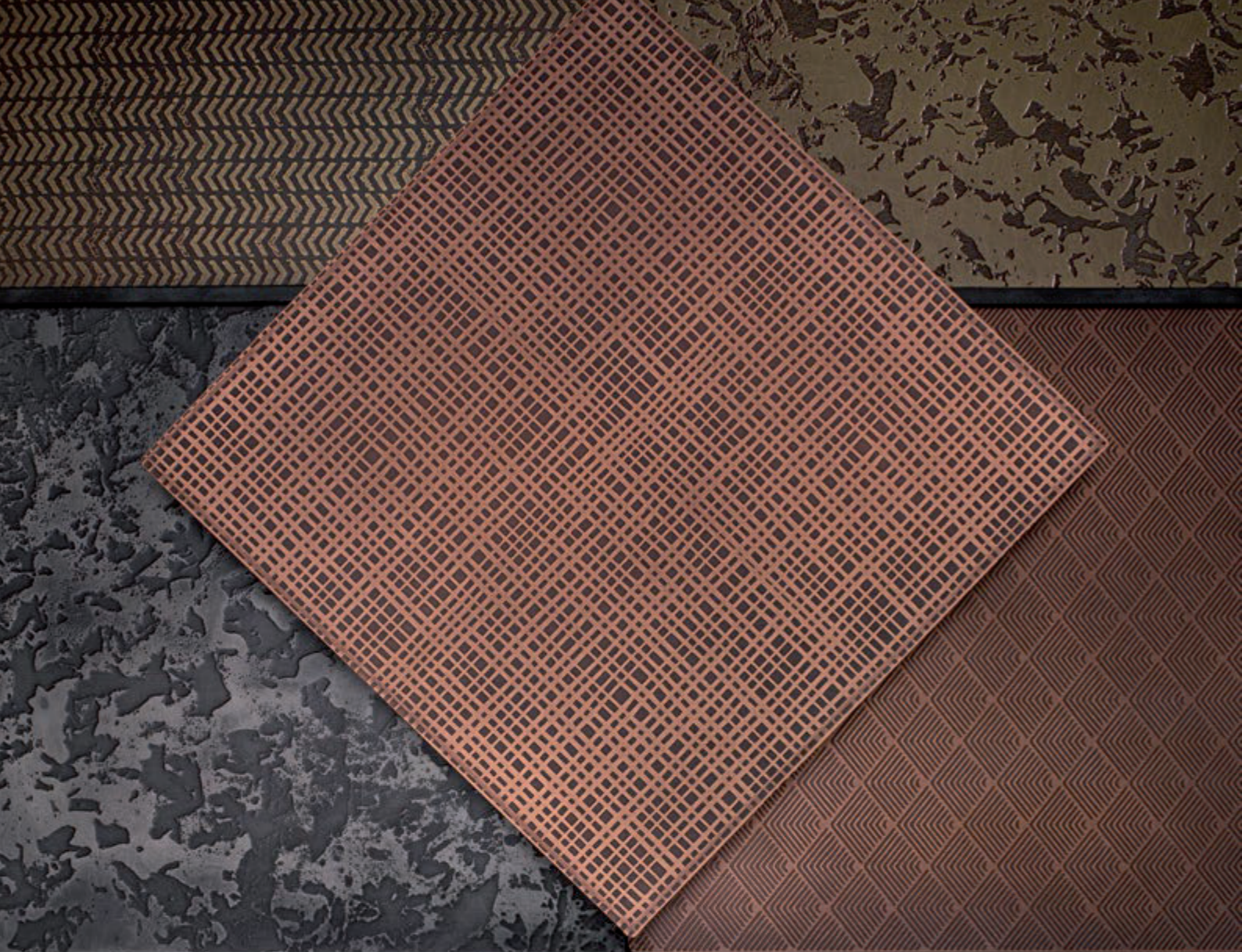

DIMENSIONS
30 x 30 cm

WEIGHT
16-17,8 kg/m²

THICKNESS
2 mm

USAGE
Wall, Indoor

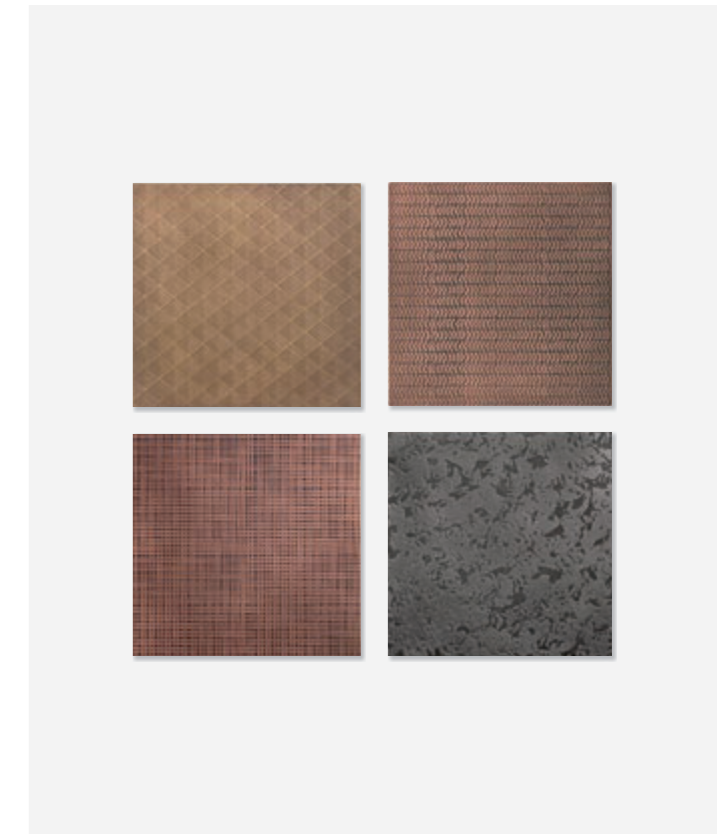

DATA SHEET P.383

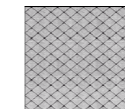

DS107-H4 MINI

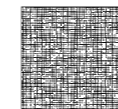

DS107-H6 MINI

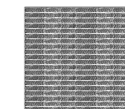

DS107-H7 MINI

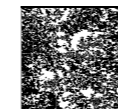

DS107-H8

DeErosion H4 DS107
DeErosion on brass H4M-OT

DeErosion H7 DS107
DeErosion on copper H7M-RA

DeErosion H6 DS107
DeErosion on copper H6M-RA

DeErosion H8 DS107
DeErosion on stainless steel H8

TILES

DESIGN BY R&D DE CASTELLI

The DeErosion collection is the culmination of a long-standing experimentation, and is obtained by integrating technological solutions with completely manual techniques employing craftsmanship of the highest order. The distinctive finishing is created using controlled erosion of the metal, the result of ongoing research into materials which has always been a hallmark of De Castelli. The extremely versatile working process amplifies the vibrant appearance of the material, creating a great sense of depth.

Le collezioni DeErosion sono il risultato di un lungo lavoro di sperimentazione ottenuto integrando soluzioni tecnologiche con tecniche completamente manuali tipiche dell'alto artigianato. La particolare finitura prevede l'erosione controllata del metallo, frutto della continua ricerca sui materiali alla quale De Castelli si dedica da sempre. L'estrema versatilità della lavorazione amplifica le vibrazioni della materia esaltandone la profondità.





Forma

DIMENSIONS

 7 sizes available

WEIGHT

 16–17,8 kg/m²

THICKNESS

 2 mm

USAGE

Wall, Indoor

DATA SHEET P.384

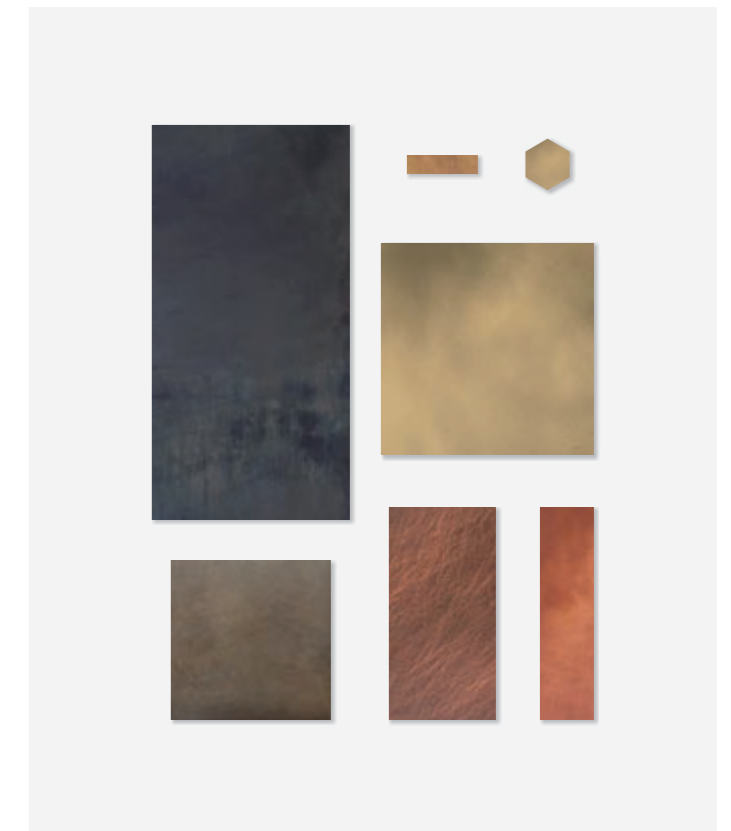
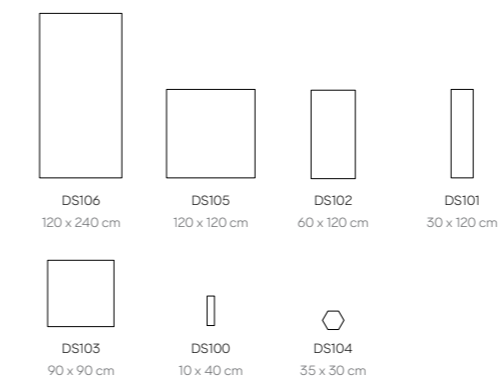

DESIGN BY R&D DE CASTELLI

The distinctive feature of this line of compositional modules suitable for both small and large spaces is the great variety of formats and finishes. With the utmost attention to every detail, the modules are cut and finished by hand, ensuring the edges and corners of each piece are particularly smooth.

La grande varietà di formati e di finiture è il tratto distintivo di una linea di moduli compositivi adatti sia a piccoli che a grandi spazi. Curati in ogni dettaglio, i moduli sono tagliati e rifiniti a mano, per conferire ad ogni pezzo un'inconsueta morbidezza ai bordi ed agli angoli.



Forma 10x40 Tiles
DS100-M9/F2/G3/G7

Parsec 98 bowl Coffee table P.182
DC621V-M5

Luce Solida 42 Lighting P.220
DC470-E5



Forma 35x30 Tile
DS104-G12/M10/G5/G4

Luce Solida 42 Lighting P.220
DC470-E5

Roma 137 Table P.132
DC609-RA

Via Veneto Chair P.152
DC654-G2



Forma 30X120 Tile
DS101-M10/G5/G4/G6



Forma 30x120 Tile
DS101-F2

Forma 60x120 Tile
DS102-M9/F2/G3/G7



Forma 10x40 Tile
DS100-G1

Sunrise Coffee table P.192
DC535-RA

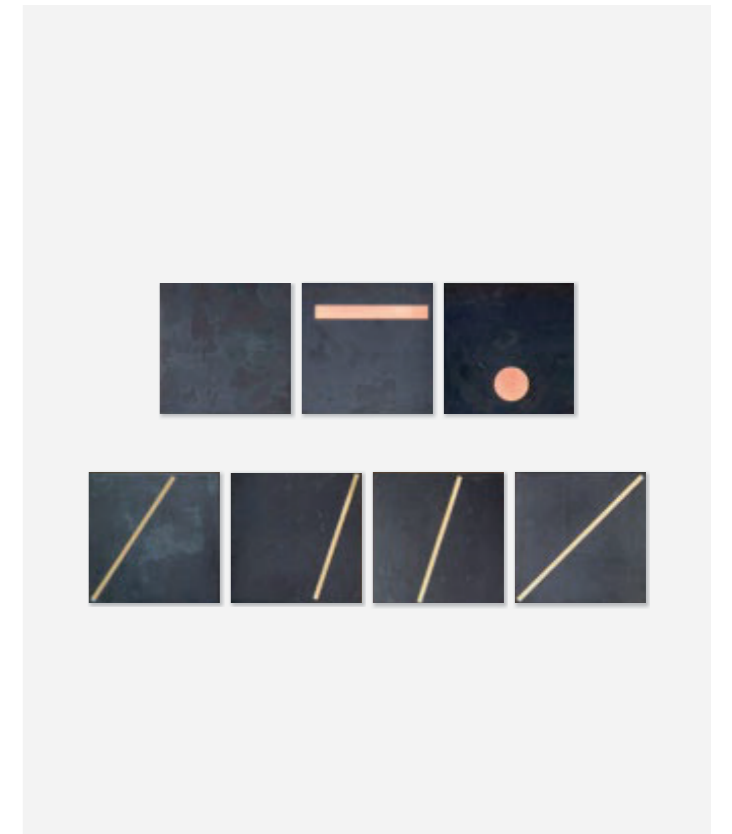

DIMENSIONS

 30 x 30 cm

WEIGHT

 25,2 kg/m²

THICKNESS

 4 mm

USAGE

Wall, Indoor

DATA SHEET P.385

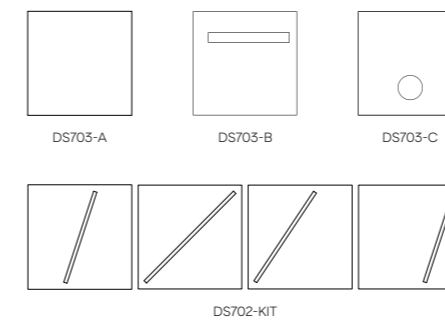

 Yoko DS703-A, DS703-B, DS703-C
DeDeep stainless steel G12
Brushed copper inserts M10

Yoko DS702-KIT
Brushed brass inserts M9
DeDeep stainless steel G12

TILES

DESIGN BY LEONARDO SONNOLI

The graphic language that Leonardo Sonnoli harnesses to express De Castelli's know how plays with a range of inlaid surfaces, where the precise angle of the ornamental inlays alludes to an aesthetic code of enigmatic symbolism. Yoko is a system of DeLabré stainless steel modules with inserts in brushed brass or copper. It lends itself to random design as a method for creating unique and original compositions. Yoko combines graphic design and craftsmanship in a visual result of great elegance inspired by modern and contemporary art.

Il linguaggio grafico in cui Leonardo Sonnoli esprime il know-how De Castelli dà vita ad un gioco di superfici intarsiate, dove la precisa inclinazione dei tasselli ornamentali allude ad un codice estetico fatto di segni enigmatici. Yoko è un sistema di moduli in acciaio DeLabré con inserti in ottone o rame spazzolato, che accoglie la casualità come metodo per la creazione di composizioni sempre uniche e originali. Yoko unisce disegno grafico e sapienza artigiana in un esito visuale di grande eleganza che trae ispirazione dall'arte moderna e contemporanea.



Yoko Tile
DS702-KIT



Yoko Tile
DS703-A / DS703-B / DS703-C

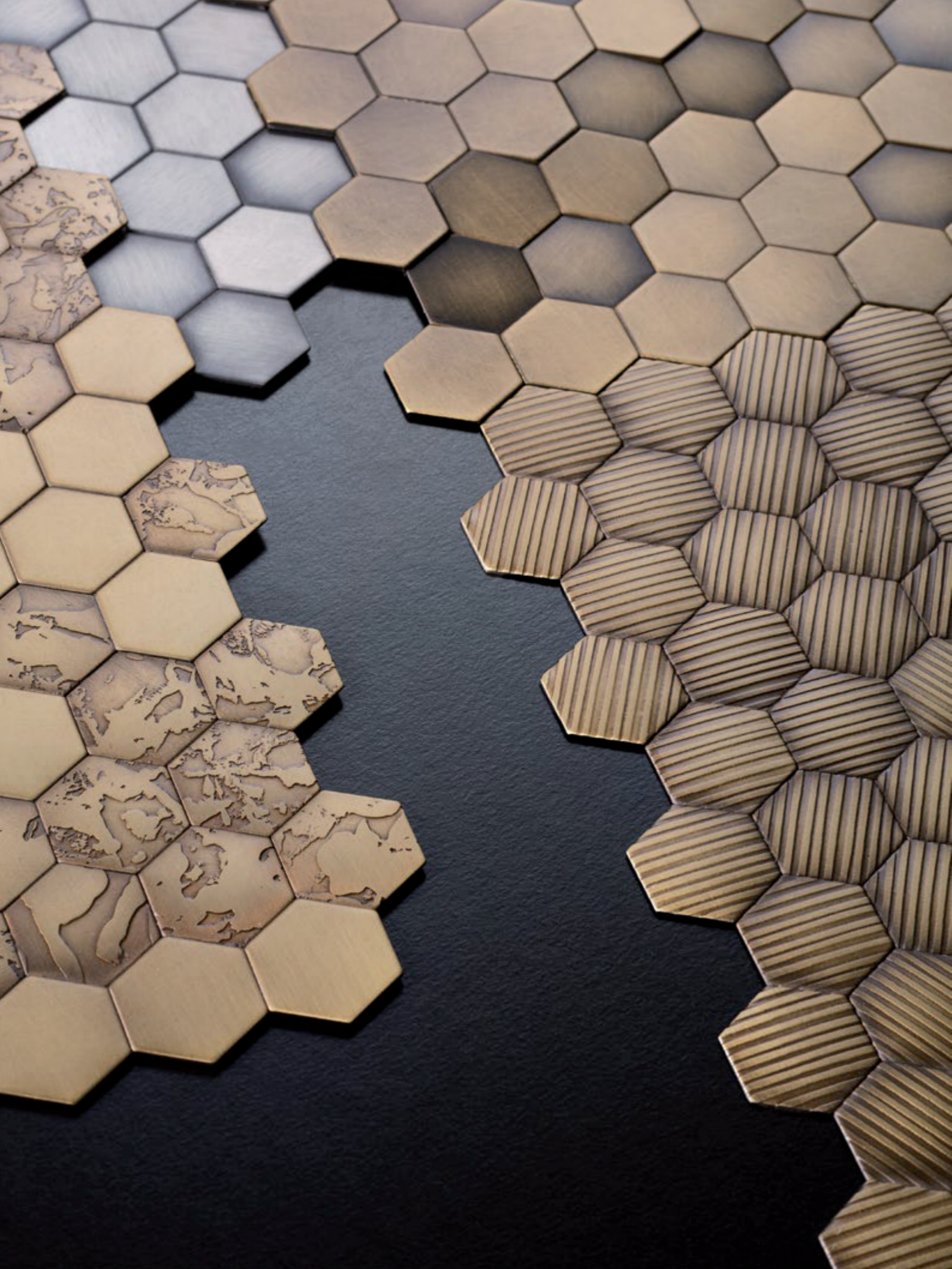

Copycat

DIMENSIONS

 32,5 x 32 cm

THICKNESS

 2 mm

WEIGHT

 12-13,3 kg/m²

USAGE

Wall/Floor, Indoor

DATA SHEET P.385

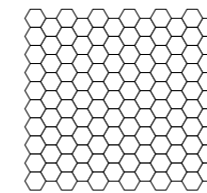

DS706

7
Copycat Mosaic DS706
Metal mix C16
Copper C2
Brass C1
Stainless steel C3
DeErosion C23/C24/C25

MOSAICS

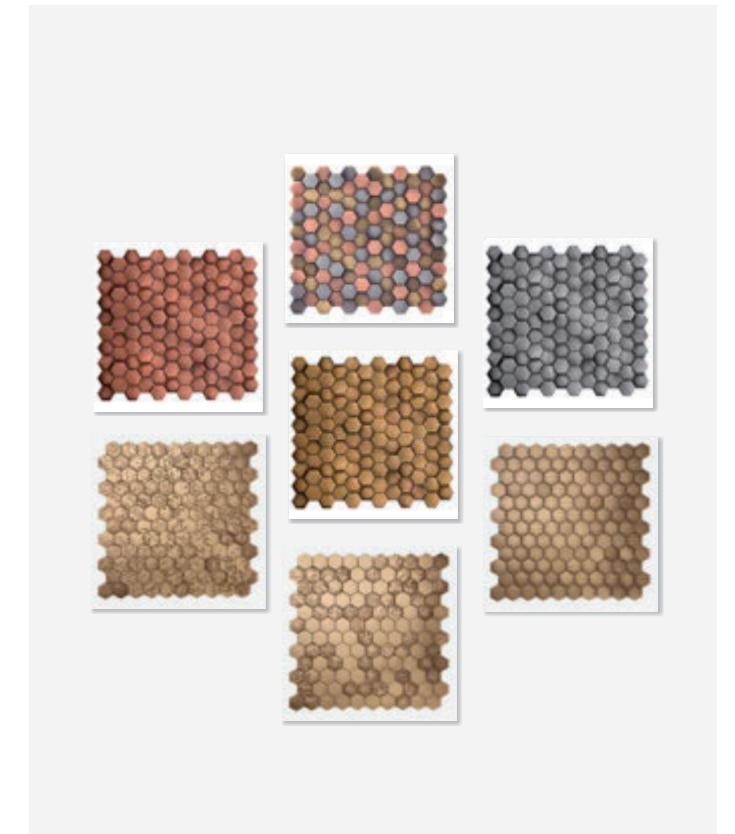

DESIGN BY CINO ZUCCHI

A superb blend of design, technology and experimentation has made it possible to create Copycat, an elegant hexagonal mosaic, designed by the architect Cino Zucchi. Copycat is designed to scenically decorate prestigious environments, offering a medium with which one can transcend the usual design constraints. The geometry of the pattern, which employs the natural shapes of honeycombs or ice crystals, contributes to the complexity of the design, whose uniqueness is rendered even more distinctive by the manual production techniques that belong to De Castelli how-how.

L'incontro fra design, tecnologia e sperimentazione ha reso possibile la realizzazione di Copycat, elegante mosaico a tessera esagonale, disegnato dall'architetto Cino Zucchi. Copycat è pensato per decorare scenograficamente ambienti prestigiosi, superando i consueti vincoli progettuali. La geometria della tessera, che riprende le forme naturali dei nidi d'ape o dei cristalli di ghiaccio, concorre alla complessità del disegno, reso unico dalle tecniche produttive manuali utilizzate da De Castelli nella sua realizzazione.



↑
Copycat Mosaic
DS706-C3

↗
Copycat Mosaic
DS706-C2



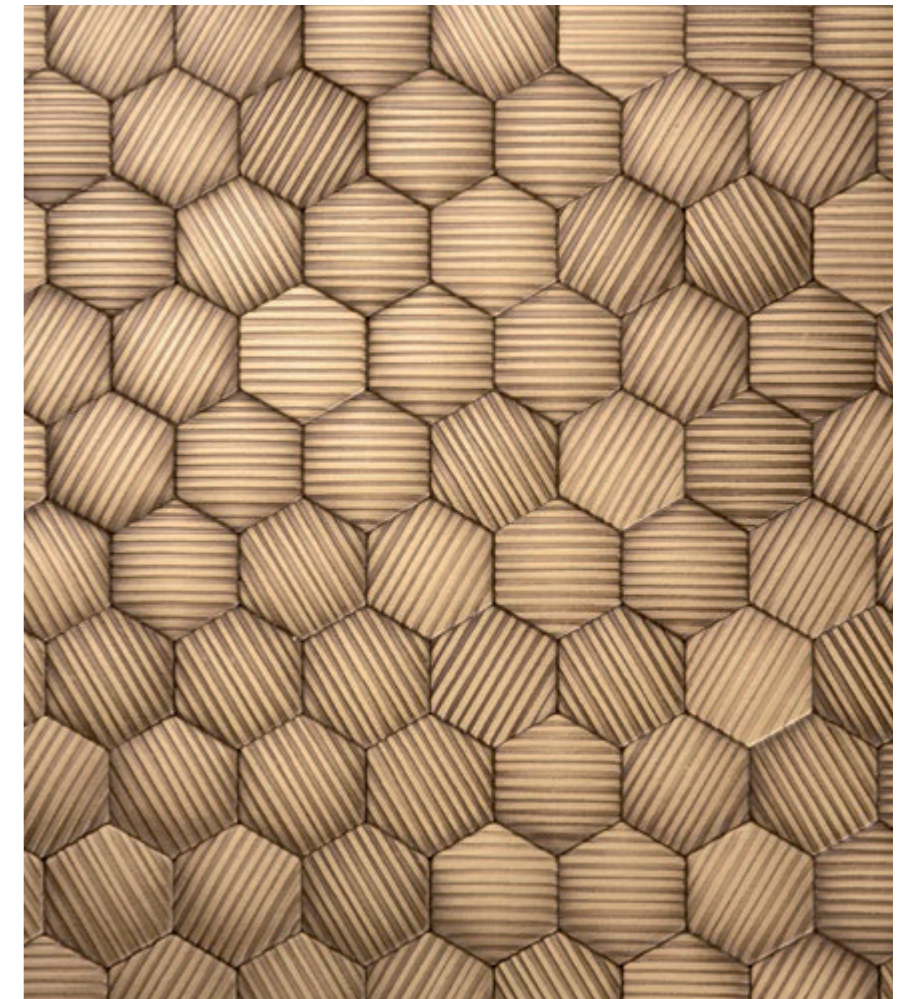

Copycat Mosaic
DS706-C25

←
Copycat Mosaic
DC706-C1



Diamond 30

DIMENSIONS
 33,5 x 33,5 cm

THICKNESS
 4 mm

WEIGHT
 12-13,3 kg/m²

USAGE
 Wall/Floor, Indoor

DATA SHEET P.386

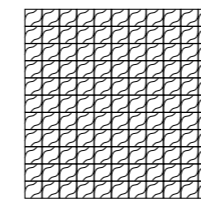

DS708

↗
 Diamond Mosaic ds708
 Brass C9
 Stainless steel C12
 Copper C7

MOSAICS



DESIGN BY R&D DE CASTELLI

The distinctive punched design that embellishes each tile gives great depth of texture to the surface, which is further enhanced by the DeLabré finishes. Diamond 30 embodies and showcases the meticulous care that goes into producing each and every piece, enhancing the physical value of the material. Each module provides a textural reminder of the craftsmanship employed in its production.

La peculiare punzonatura eseguita su ogni tessera imprime una texture profonda alla superficie, sottolineata dalle finiture DeLabré. Diamond 30 porta con sé la traccia evidente della meticolosa cura con cui ogni pezzo viene prodotto, valorizzando la fisicità della materia e cristallizzando in ogni modulo la memoria tattile della lavorazione artigianale.

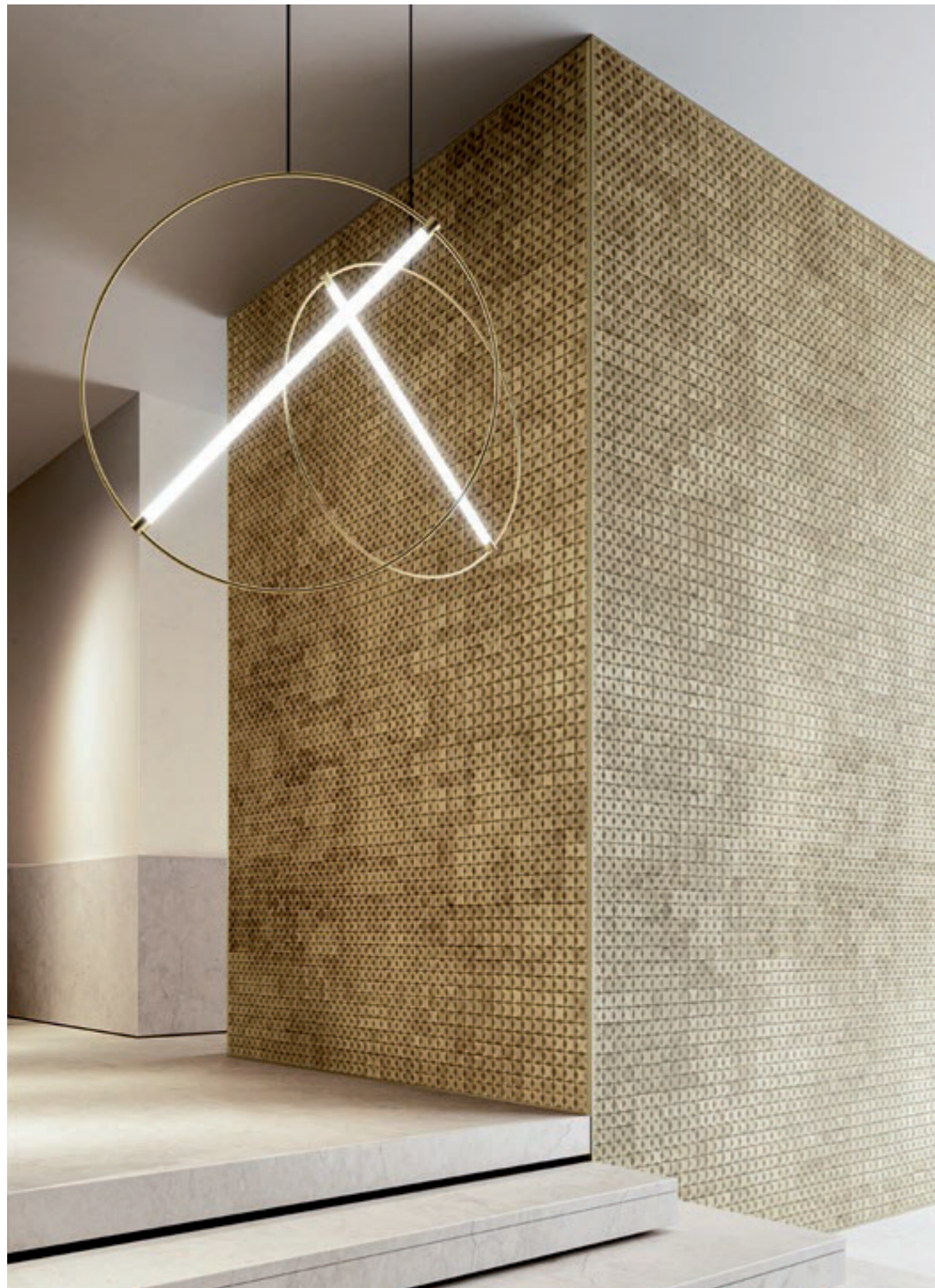

↑
Diamond Mosaic
DS708-C9

↗
Diamond Mosaic
DS708-C12



Losanga



DIMENSIONS

 2 sizes available

THICKNESS

 2 mm

WEIGHT

 12-13,3 kg/m²

USAGE

Wall/Floor, Indoor

DATA SHEET P.386

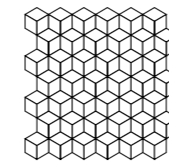

LOSANGA A - DS712
30,2 x 32 cm

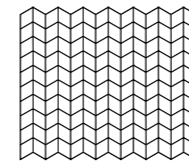

LOSANGA B - DS713
35 x 30,4 cm

DESIGN BY NIKITA BETTONI

Formal elegance and perfect craftsmanship characterise the Losanga mosaic, with its distinctive rhomboid tile design. The two or three element arrangement gives rise to complex patterns, made even more precious by the nuances of the DeLabré workmanship, which lends a three-dimensional optical illusion to the surface.

Eleganza formale e perfezione esecutiva caratterizzano il mosaico Losanga, dal particolare disegno a tessere romboidali. La disposizione a due o a tre elementi dà origine a pattern complessi, resi ancora più preziosi dalle nuance della lavorazione DeLabré, che assicura alla superficie l'illusione ottica della tridimensionalità.

↗
Losanga A Mosaic DS712
Stainless steel C19
Brass C17
Copper C18

Losanga B Mosaic DS713
Stainless steel C22
Brass C20
Copper C21

MOSAICS



↑
Losanga A Mosaic
DS712-C17

↗
Losanga B Mosaic
DS713-C22

Burraco Table P.112
DC646-M10



Square 30

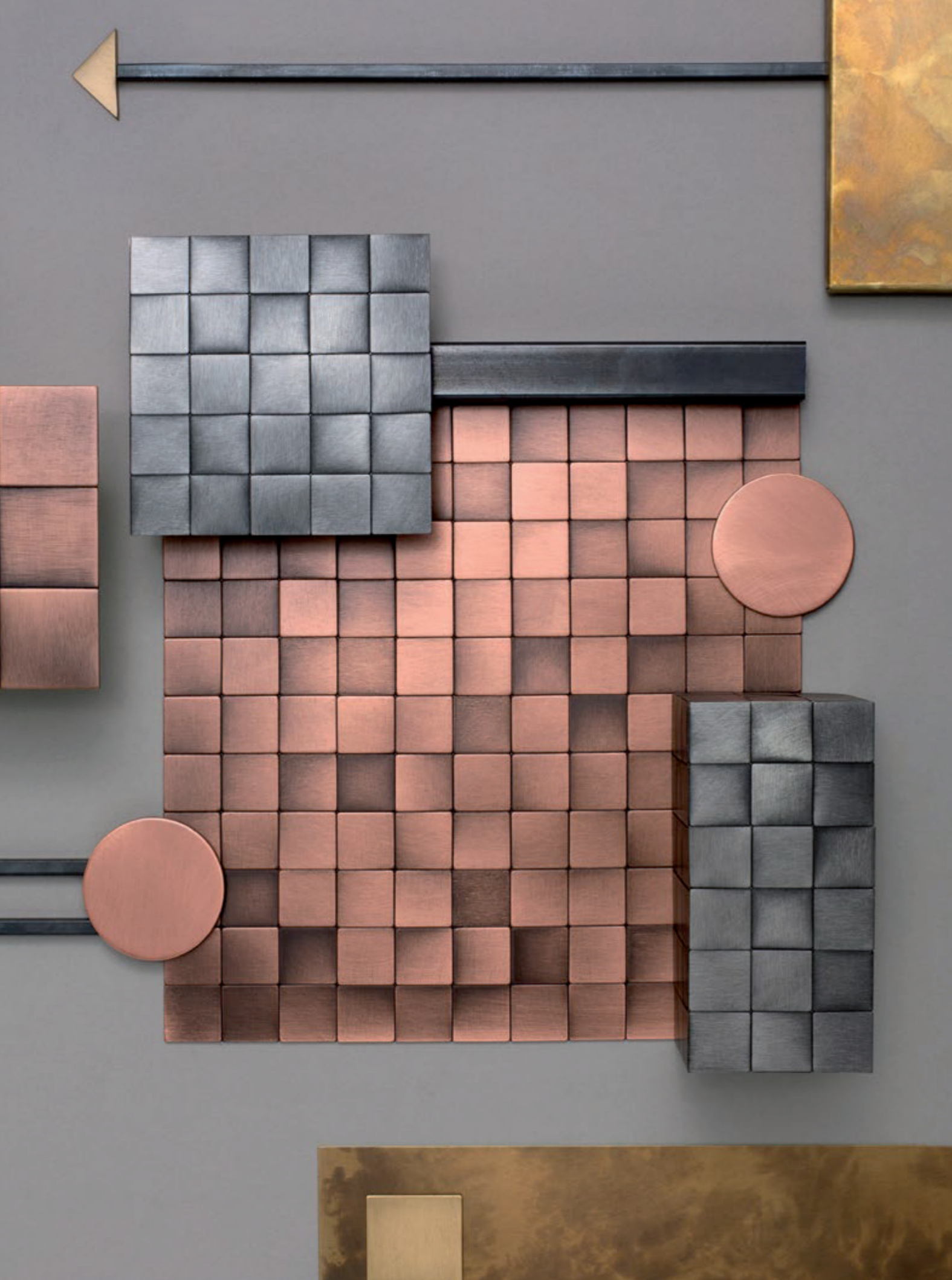

DIMENSIONS
33,5 x 33,5 cm

THICKNESS
2 mm

WEIGHT
12-13,3 kg/m²

USAGE
Wall/Floor, Indoor

DATA SHEET P.386

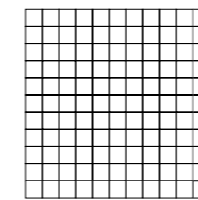

DS707

↗
Square 30 Mosaic DS707
Brass C13
Stainless steel C15
Copper C14

MOSAICS

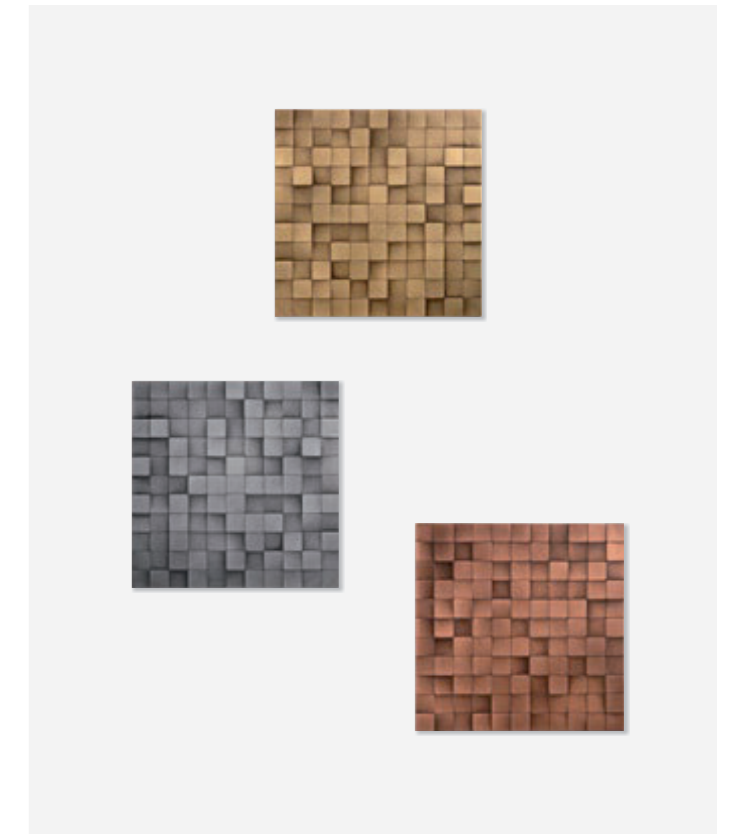

DESIGN BY R&D DE CASTELLI

The reduced dimensions of the modules determine the complexity of the mosaic design, expressing even greater sense of depth and giving life to highly poetic composition comprising small and infinitely-varied chromatic and tactile variations. Square 30 combines the rigorous and essential geometry of the square module adorned with the richness of the De Castelli oxidation effect, to create a formal balance of great elegance.

La dimensione contenuta dei moduli determina la complessità del tessuto musivo, che qui assume nuova profondità e dà vita ad una composizione poetica fatta di piccole e continue variazioni cromatiche e tattili. Square 30 combina la geometria rigorosa ed essenziale del modulo quadrato con la ricchezza delle ossidazioni De Castelli, in un equilibrio formale di grande eleganza.

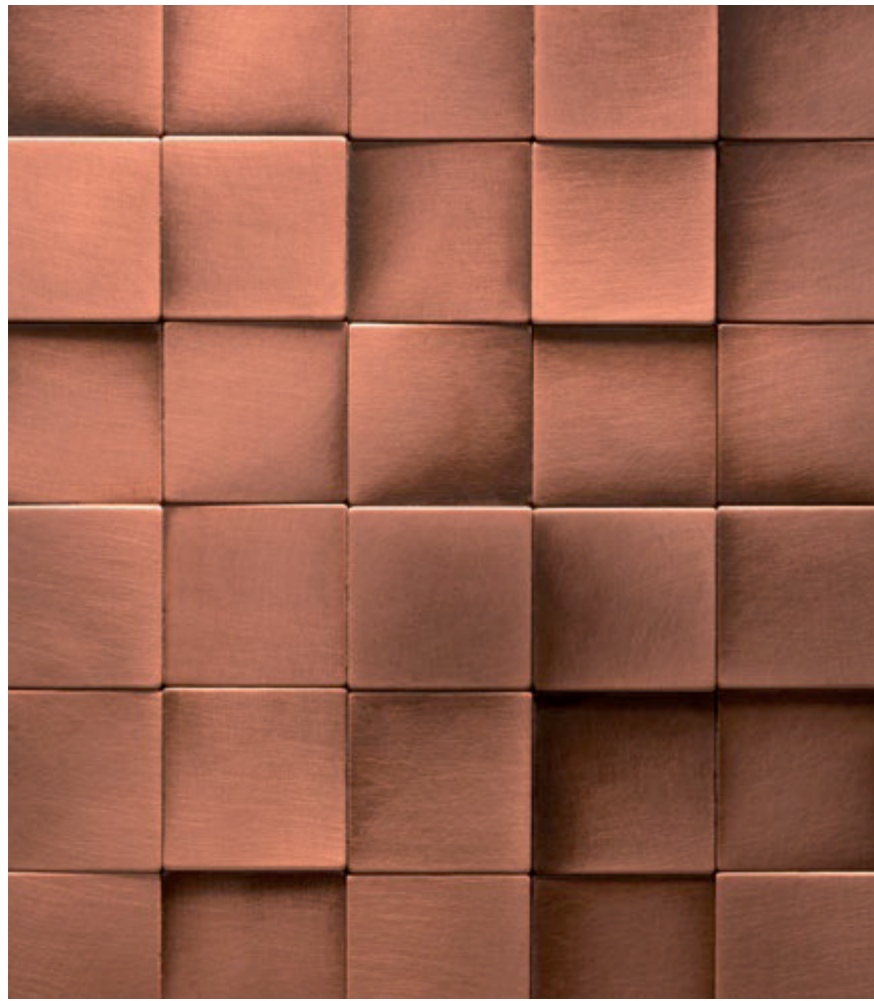

Square 30 Mosaic DS707
Copper C14



Square 30 Mosaic
DS707-C13

Square 50



DIMENSIONS
35,2 x 35,2 cm

THICKNESS
2 mm

WEIGHT
12-13,3 kg/m²

USAGE
Wall/Floor, Indoor

DATA SHEET P.386

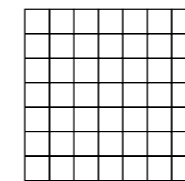

DS709

↗
Square 50 Mosaic DS709
Brass C4
Stainless steel C6
Copper C5

MOSAICS

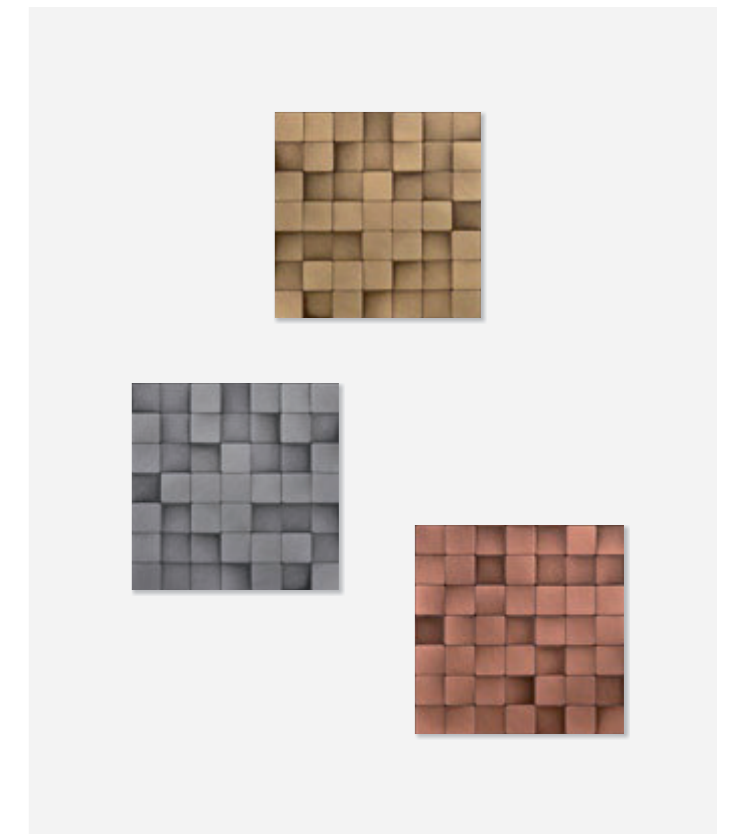

DESIGN BY R&D DE CASTELLI

The repetition of the square module is combined with the three-dimensional effect created by the varying thickness of the individual tiles. Light and shadow ripple across the space with a wholly original chromatic effect conferred by the DeLabré finishes. The total compositional freedom of the format provides the designer with the opportunity to create architectural solutions in both vertical and horizontal planes.

La ripetizione del modulo quadrato si combina con l'effetto tridimensionale creato dallo spessore variabile delle singole tessere. Luci e ombre increspano lo spazio con l'inedito esito cromatico conferito dalle finiture DeLabré. L'estrema libertà compositiva permessa dal formato offre al progettista la possibilità di immaginare soluzioni architettoniche sia in verticale che in orizzontale.



↑
Square 50 Mosaic
DS709-C4

↖
Square 50 Mosaic
DS709-C6



3D Wall

DIMENSIONS

20 x 20 cm

WEIGHT

20 kg/m²

THICKNESS

30 mm

USAGE

Wall, Indoor

DATA SHEET P.387

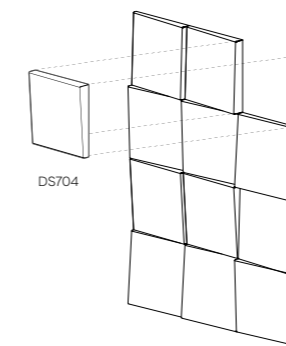

3D Wall Decorative DS704
DeLabré Brass F2

DECORATIVE



DESIGN BY R&D DE CASTELLI

3D Wall is an effective wall cladding system, providing maximum composition flexibility. The square-shaped modules, diagonally sectioned, are fixed by magnets to a special metal sheet anchored to the wall. The different depths of the sides, coupled with the possibility to customise the modules with the range of De Castelli finishes, accentuate the sculptural aspect of 3D Wall: by rotating each element by 90°, it is possible to play on the alternation of colours and thicknesses to emphasize its three-dimensional quality.

3D Wall è un efficace sistema di rivestimento a parete, caratterizzato dalla massima flessibilità di composizione. I moduli di forma quadrata, sezionati in diagonale, vengono fissati tramite magneti ad una apposita lamiera ancorata a muro. Le diverse profondità dei lati, insieme alla possibilità di personalizzare i moduli nelle svariate finiture De Castelli, accentuano l'aspetto scultoreo di 3D Wall: ruotando di 90° ogni elemento, è possibile giocare sull'alternanza di cromatismi e spessori per enfatizzarne la tridimensionalità.

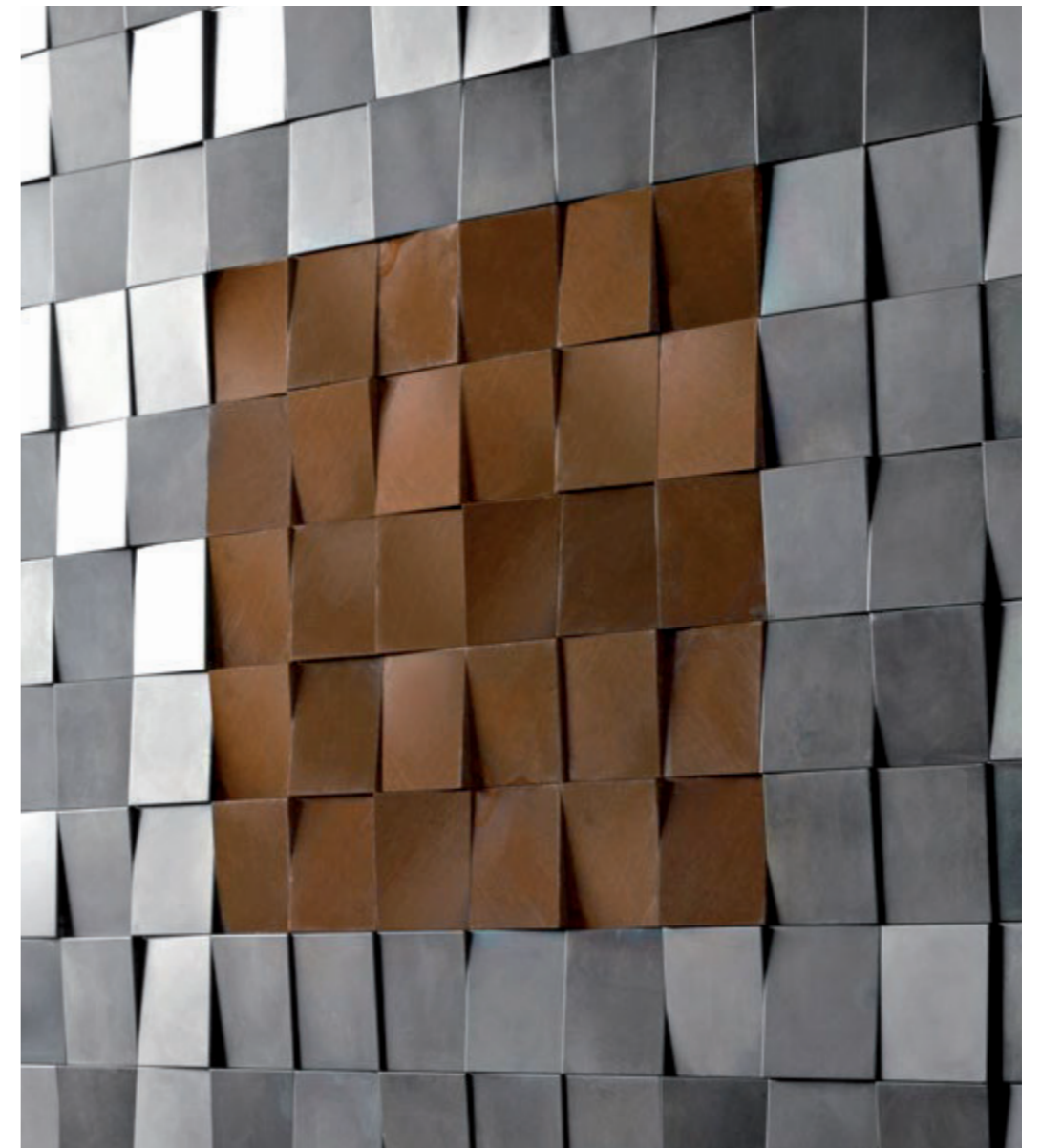
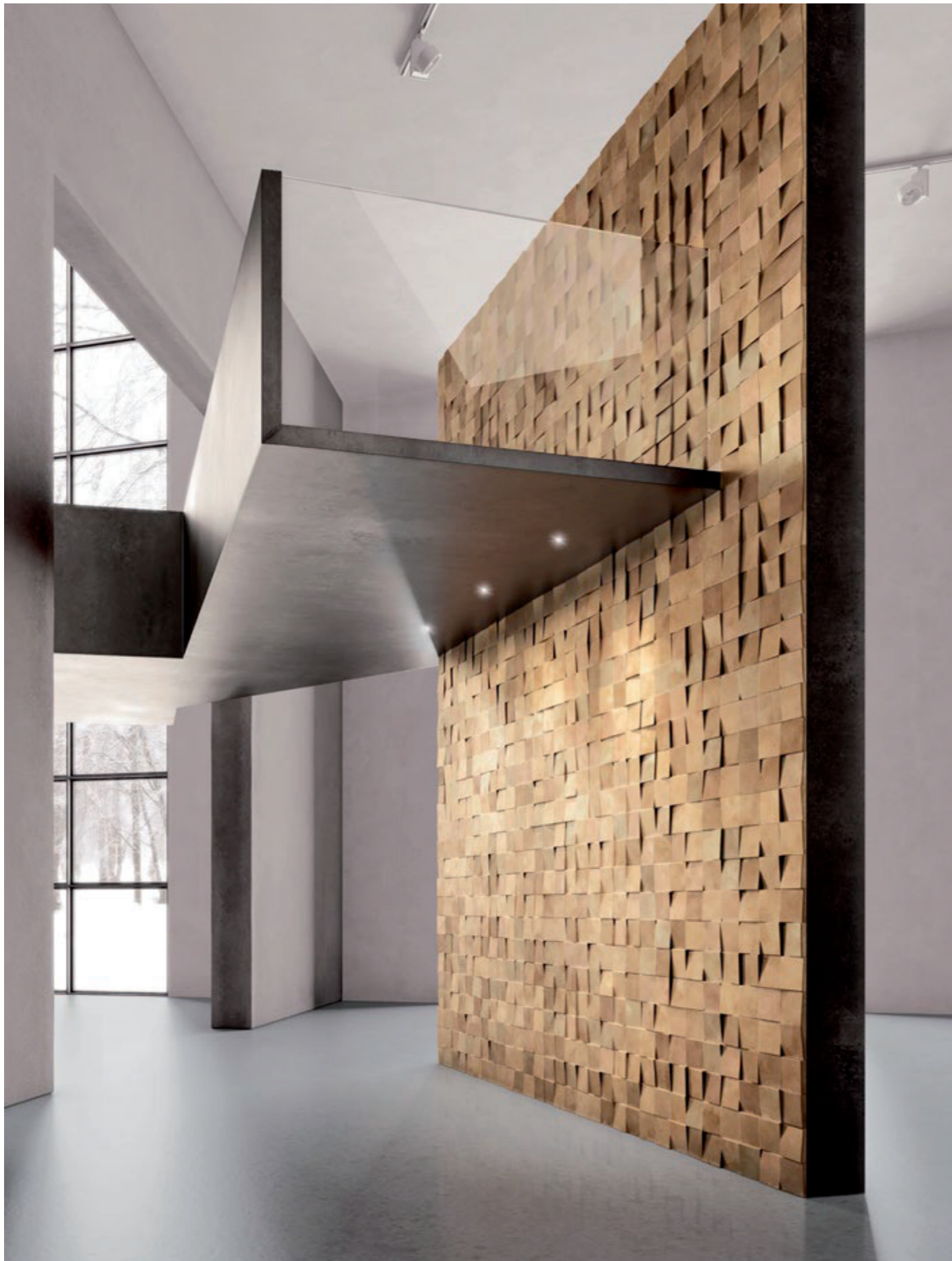

↖
3D Wall Decorative
DS704-M7

↗
3D Wall Decorative
DS704-G12/D6

Circle Wall

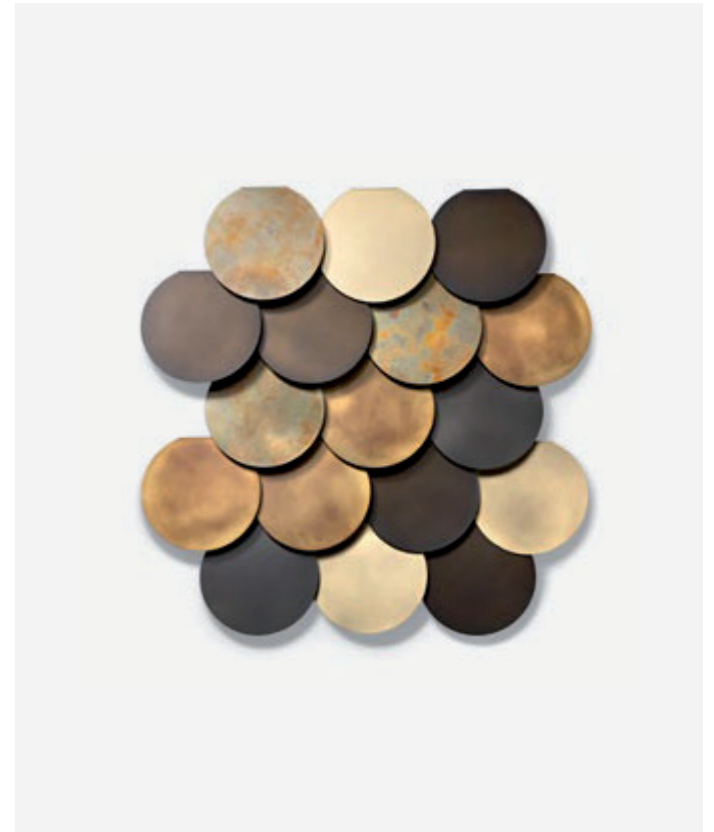

DIMENSIONS

∅ 18 cm

THICKNESS

45 mm

WEIGHT

12 kg/m²

USAGE

Wall, Indoor/Outdoor

DATA SHEET P.387

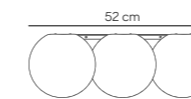
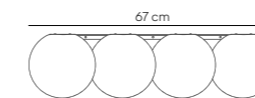
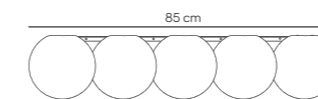

DS701

Circle Wall Decorative DS701
Mix finishes on brass MIX-OT

DECORATIVE

DESIGN BY R&D DE CASTELLI

The overlapping round modules create a sumptuous pattern for decorating walls. Circle Wall is a cladding system that plays with the warm nuances of brass produced in a range of precious finishes. The satinised, oxidized and brushed metal is arranged in an uninterrupted sequence of variations to create a rich colour palette in differing hues ranging from gold to bronze, and from burnt brown to dark brown. Available in a range of finishes, Circle Wall showcases the expressive potential of De Castelli surfaces in an original way.

La sovrapposizione di moduli rotondi diventa un sontuoso pattern decorativo per le pareti. Circle Wall è un sistema di rivestimento che gioca con le calde nuance dell'ottone declinato nelle sue finiture più preziose. Il metallo satinato, ossidato e spazzolato si dispone secondo una sequenza ininterrotta di variazioni per creare una ricca palette cromatica che sfuma dall'oro al bronzo, dal marron bruciato al testa di moro. Disponibile nelle diverse finiture della collezione, Circle Wall svela in modo inedito le potenzialità espressive delle superfici De Castelli.



↑
Circle Wall Decorative DS701
Mix finishes on copper MIX-RA

↗
Circle Wall Decorative
DS701-MIX-OT



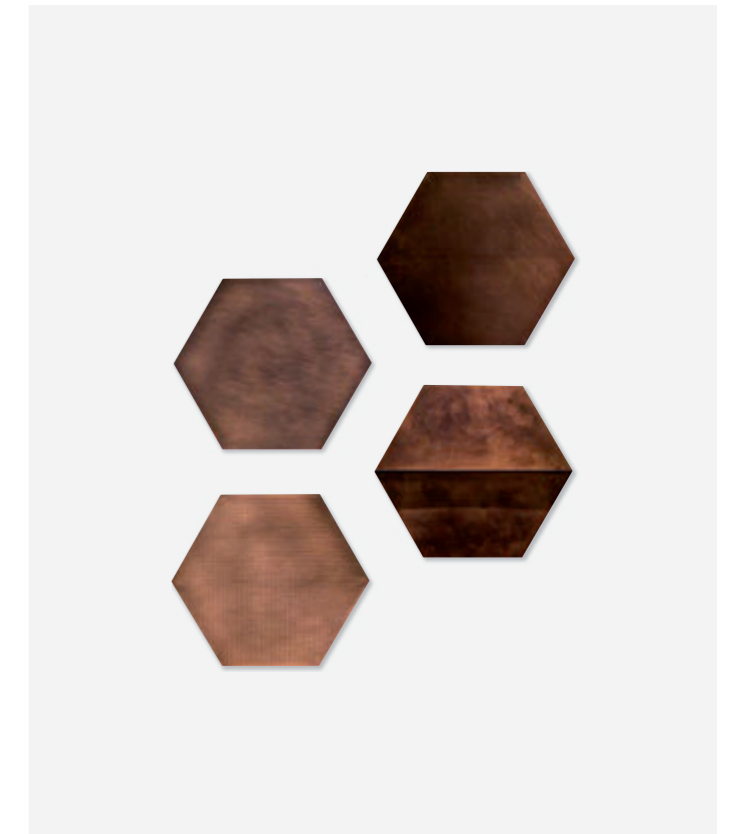



DIMENSIONS

 70 x 61 cm

WEIGHT

 5,5 kg/module

THICKNESS

 42, 52, 72 mm

USAGE

Wall, Indoor/Outdoor

DATA SHEET P.388

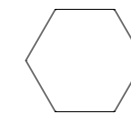

DCS705-A
Thickness 42 mm

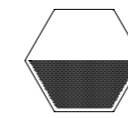

DCS705-B
Thickness 52 mm

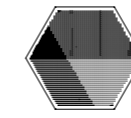

DCS705-C
Thickness 72 mm

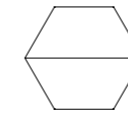

DCS705-D
Thickness 72 mm

 DecoDe Decorative DS705-A/B/C/D
Copper

DECORATIVE

DESIGN BY PINO SCAGLIONE

DecoDe is a collection of sound-absorbing hexagonal modules providing a functional, technological and aesthetic solution. The range of special finishes lends a precious look to the modules, which renders both the appearance of the material as well as the colouring unique. The laser drilling and cutting system of the metal surface, combined with the recycled polyester matting inserted inside each piece guarantee high acoustic absorption properties. With its superb blend of technical and decorative qualities, DecoDe is an interior decoration project that allows compositions to be fully customised suitable for both residential and public environments.

DecoDe propone una collezione di moduli esagonali fonoassorbenti per una soluzione funzionale, tecnologica ed estetica. La speciale gamma di finiture conferisce un aspetto prezioso ai moduli, che si rivelano unici per matericità e cromatismi. Il sistema di foratura e taglio laser delle superfici in metallo, combinato con l'inserimento di un materassino in poliestere riciclato all'interno di ogni pezzo, garantisce alte prestazioni acustiche. Tra il tecnico e il decorativo, DecoDe è un progetto di arredo che consente composizioni personalizzabili, adatto sia ai contesti residenziali che a quelli pubblici.



DeCode Decorative
DS705-A/B/C/D COMPOSITION

Nicola Coffee table **P.180**
DC625-M2 / DC624-M0 / DC623-M3

Parsec 98 Bowl Coffee table **P.180**
DC621V-M3

Copycat Mosaic **P.288**
DS706-C1

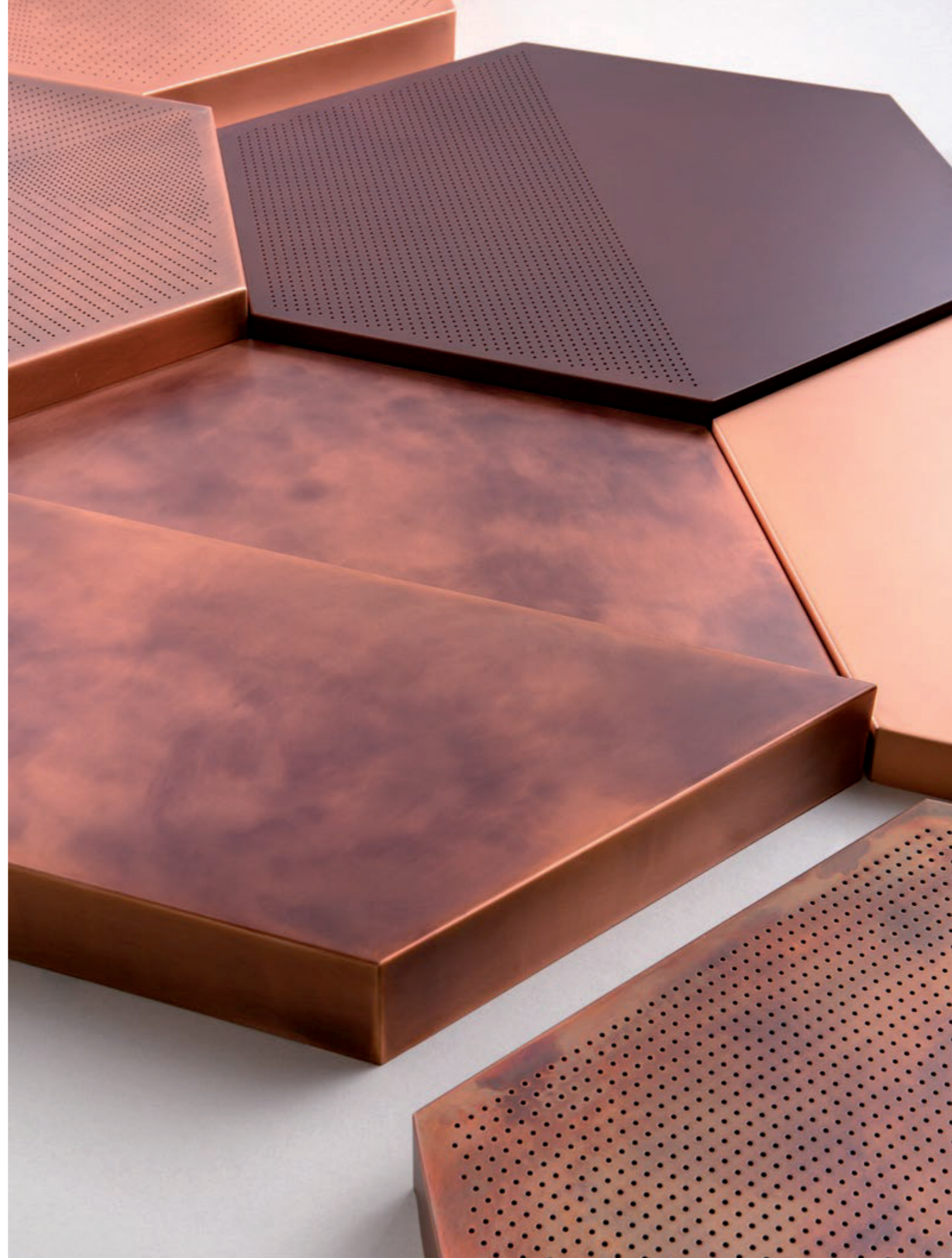

Vertical Green



DIMENSIONS

 19 x 20,5 cm

WEIGHT

 11 kg/m²

THICKNESS

 60 mm

USAGE

Wall, Indoor/Outdoor

DATA SHEET P.388

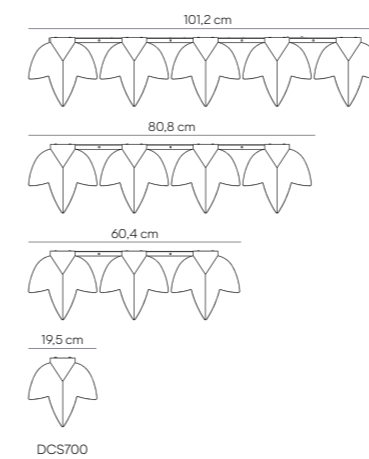

 Vertical green Decorative DS700
Mix finishes on metal

DECORATIVE

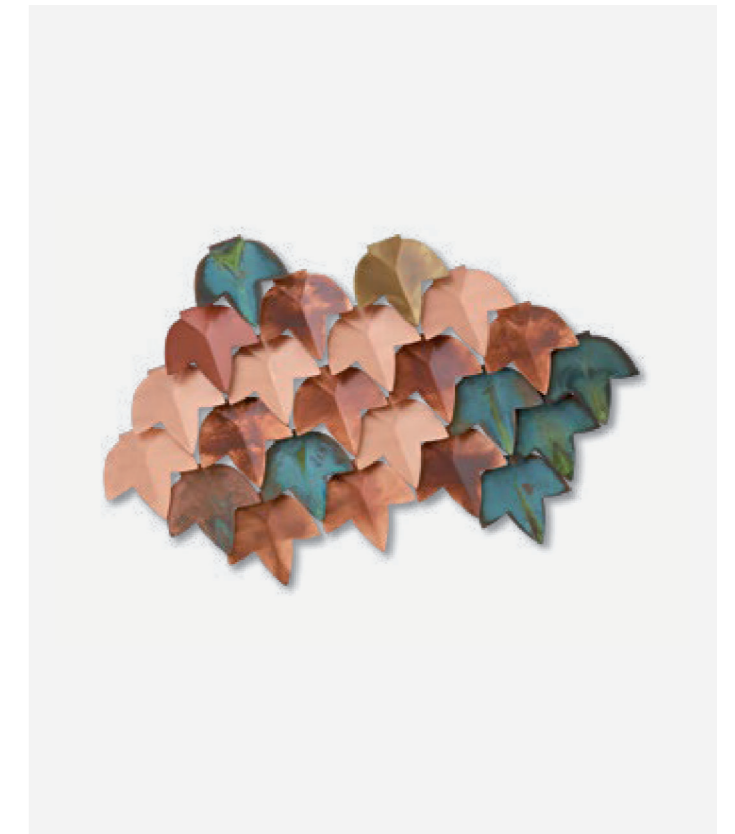

DESIGN BY R&D DE CASTELLI

This re-imagining of a three-dimensional geometric pattern fashioned with Virginia Creeper leaves is inspired by nature and has echoes of an Art Nouveau composition, whilst leaving room for abstraction. The "vertical garden" backdrop thus created evokes a characteristic autumn landscape, warmed by the choice of materials and their manifold oxidations and finishes.

L'ispirazione naturale, come in una composizione dall'espressività Art Nouveau, lascia spazio all'astrazione, nella riproposizione di un pattern geometrico ridimensionale, realizzato a forma di foglie di vite americana. Uno scenografico "giardino verticale" evoca un caratteristico paesaggio autunnale scaldato dalla scelta dei materiali e dalle loro molteplici ossidazioni e finiture.



Vertical green Decorative
DS700-MIX

Caravan 240 Sofa P.140
DC661-M10-AQ

Drops Coffee tables P.172
DC665-N1-M10
DC664-N2-M10
DC663-N20-M15



Vertical green Decorative
DS700-MIX

Boiserie & Scomposta



DIMENSIONS

 On design

WEIGHT

 Min. 18 kg/m²

THICKNESS

 Min. 35 mm

USAGE

Wall, Indoor/Outdoor

DATA SHEET P.389

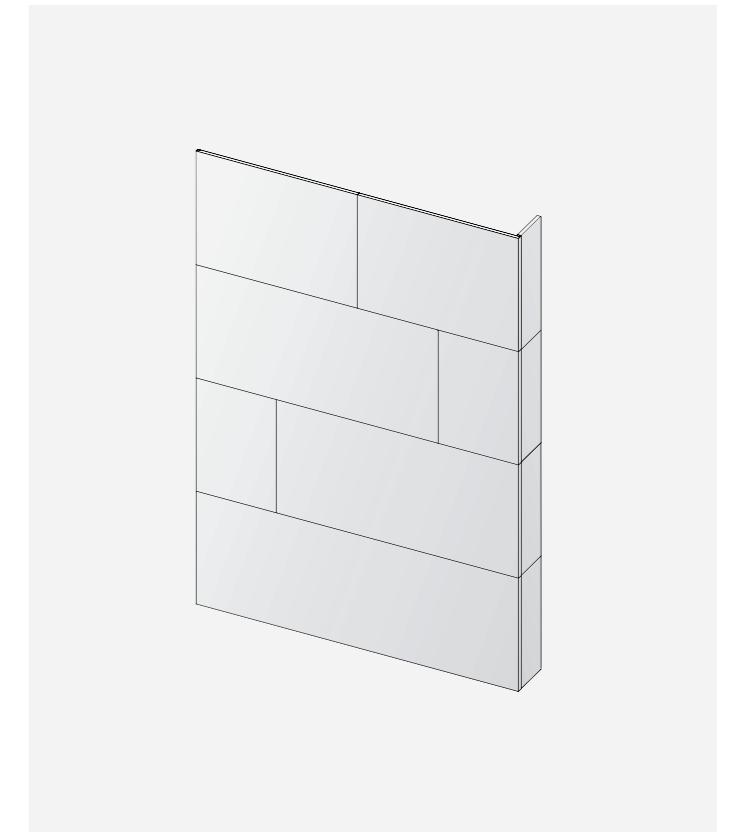
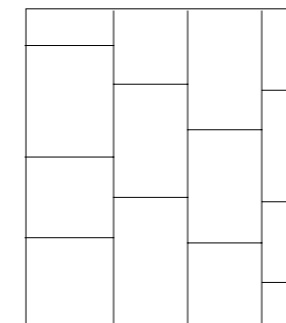

DESIGN BY R&D DE CASTELLI

Metal's special ability to change and adapt gives even basic, single-finishing surfaces a unique and stylish character. The Boiserie & Scomposta wall cladding systems offer versatile solutions for both design composition and technical requirements. Featuring boxed panels of various sizes, each system has its own distinct fixing and support method but can be customised to cover new and existing surfaces with artisanal precision.

Le peculiari capacità metamorfiche del metallo incorporano una cifra stilistica propria anche nelle superfici monocromatiche più semplici. Le possibilità offerte dai sistemi di rivestimento a parete Boiserie e Scomposta, assicurano una totale flessibilità di soluzioni compositive e tecniche. Costituiti da pannelli scatolati di diverse dimensioni, i due sistemi si differenziano per sistema di fissaggio e supporto, ma sono entrambi personalizzabili permettendo di vestire sartorialmente superfici nuove ed esistenti.



↑
Boiserie Cladding solution
DeMarea copper M5

↗
Scomposta Cladding solution
Waxed corten D7

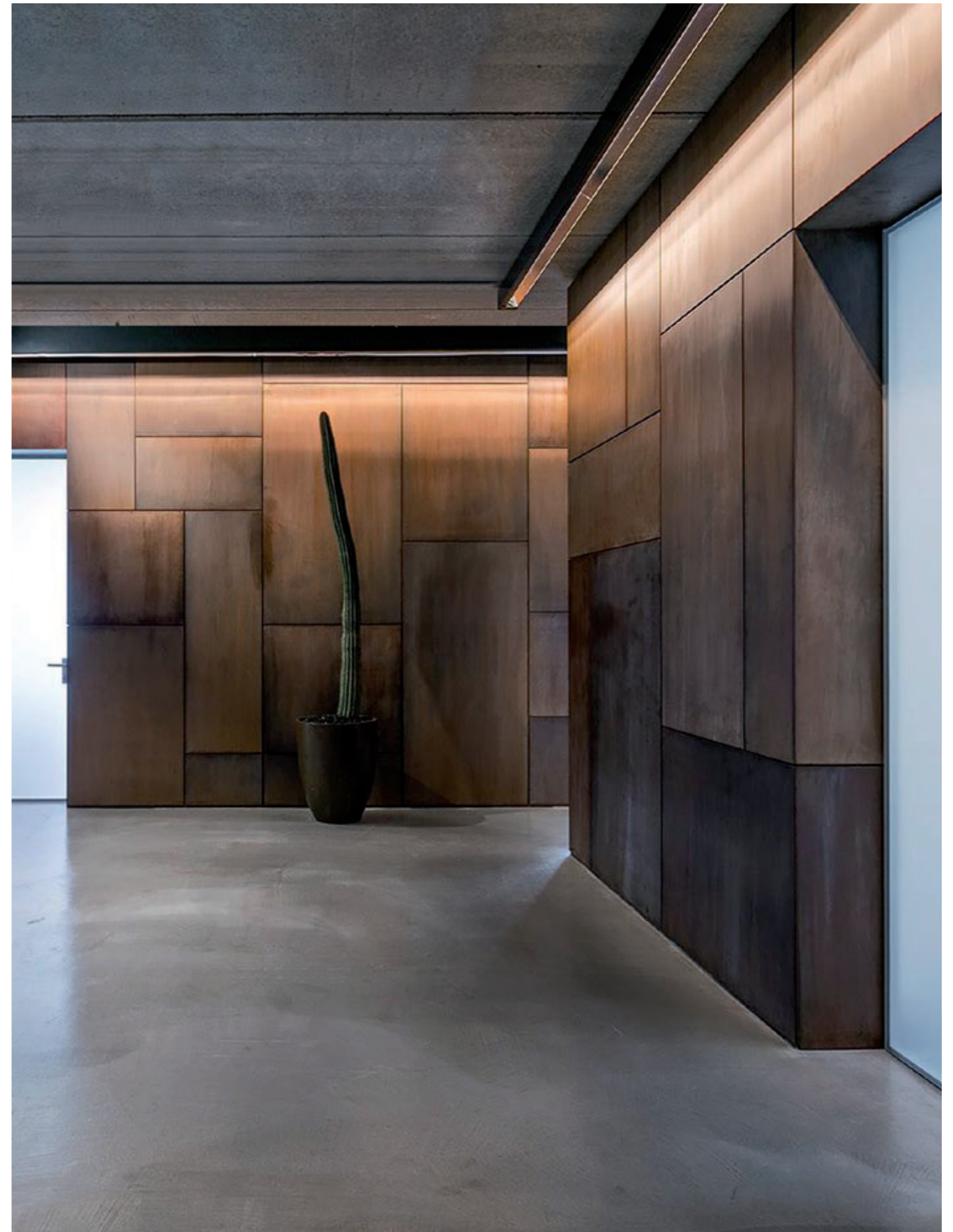

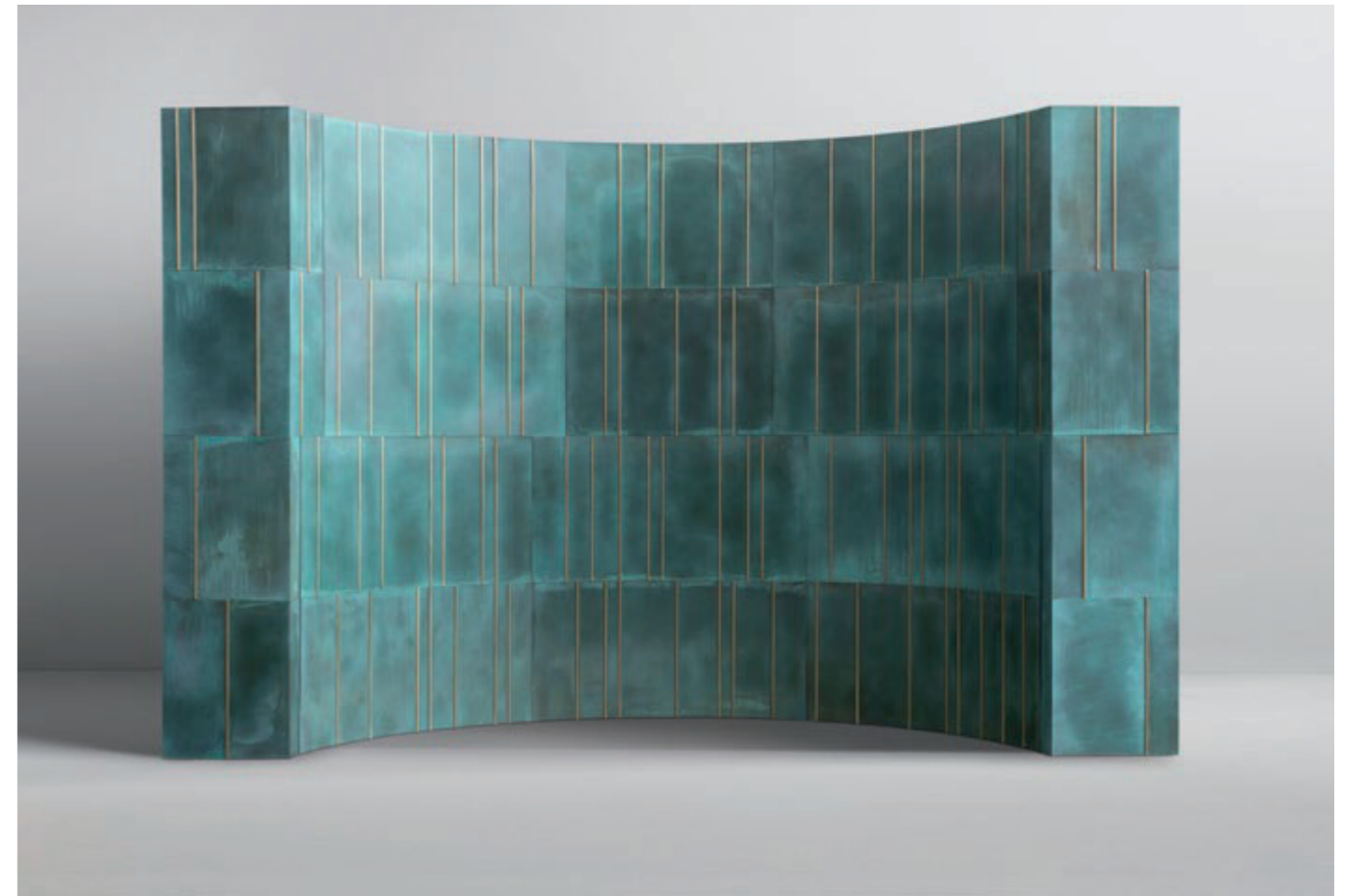
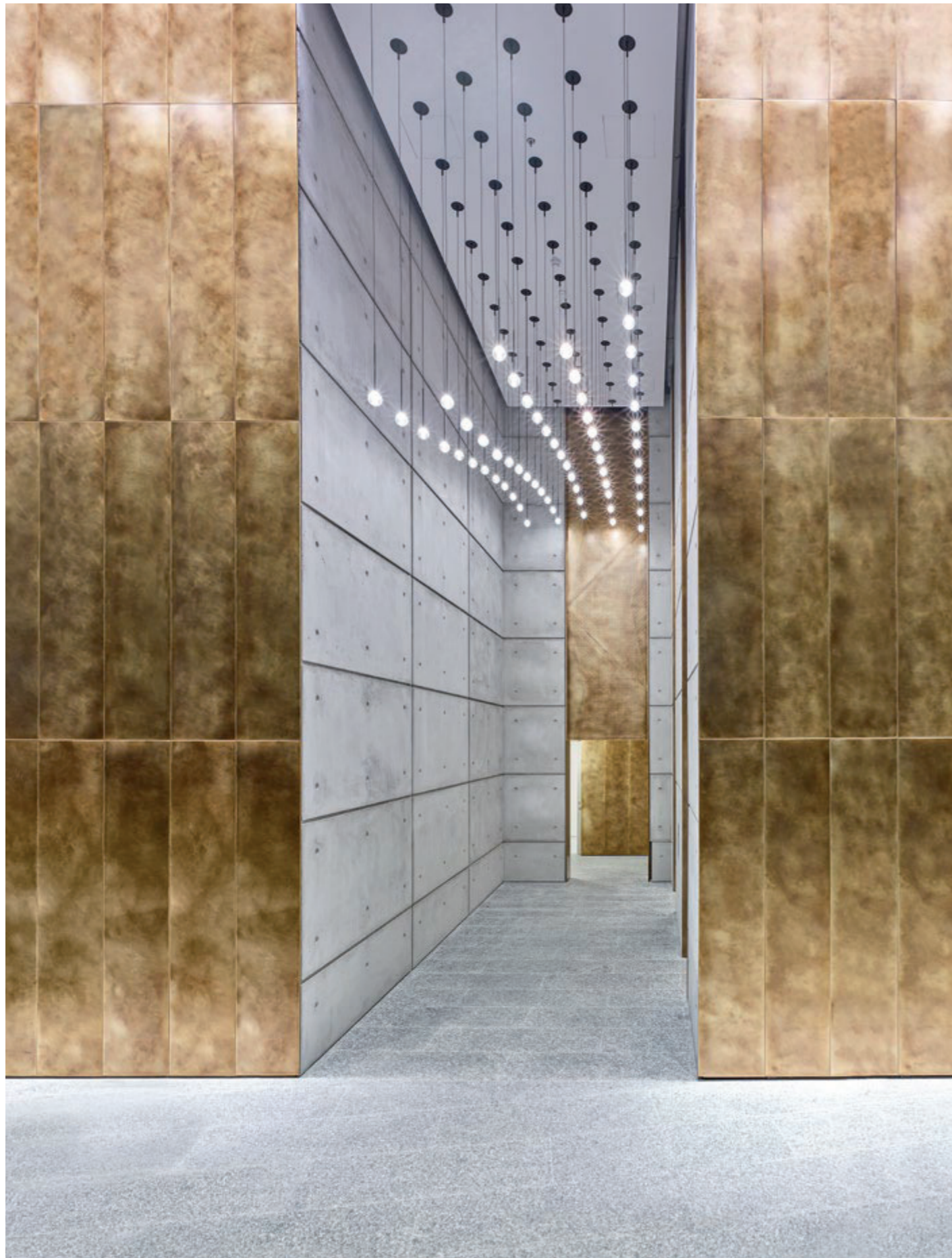

Boiserie Cladding solution
Verdigris copper F7

κ
Scomposta Cladding solution
DeLabré brass F2



↑
Boiserie Cladding solution
DeLabré brass F2, DeDeep stainless steel G12

↗
Scomposta Cladding solution
DeMarea brass M6





Scomposta Cladding solution
Verdigris copper F7



Canneté

DIMENSIONS

 60/64,5 x 267 cm

WEIGHT

 from 12,2 to 30,4 kg/m²

THICKNESS

 Min 60 mm

USAGE

Wall, Indoor/Outdoor

DATA SHEET P.390

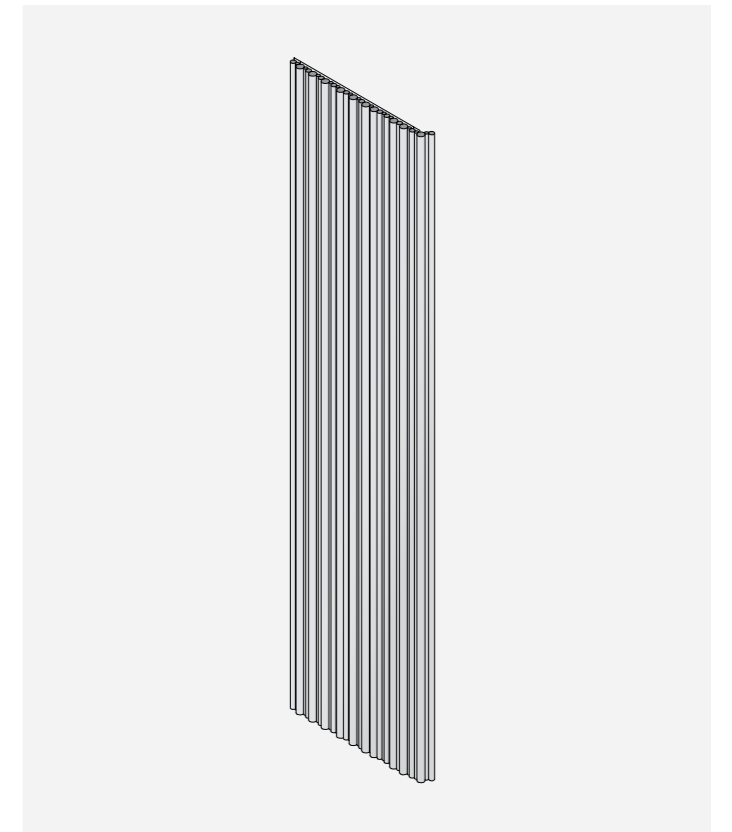
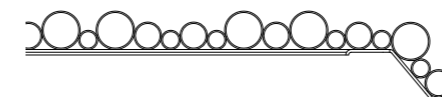

DESIGN BY R&D DE CASTELLI

The Canneto wall cladding system was inspired by the furniture collection sharing the same name. It aims to replicate the ribbed appearance on an architectural scale with the appropriate proportions and methods. Pre-made and easily combinable panels allow large vertical surfaces to be covered. The result is a soft three-dimensional effect accentuated by the alternation of vertical tubes in varying diameters. This arrangement creates a fascinating interplay of light and shadow.

Il sistema di rivestimento a parete Canneto, ispirato all'omonima collezione di arredi, ambisce a ricreare, con le dovute proporzioni e accorgimenti, la stessa texture cannettata su scala architettonica. Pannelli predefiniti e componibili fra loro permettono di rivestire ampie superfici verticali creando una morbida tridimensionalità enfatizzata dall'alteranza di tubi di diverso diametro che creano suggestive giochi di luci ed ombre.

←
Canneto Covering DS715
Brushed copper M10

Canneté Cladding solution
DS715 Orbitale DeLabrè aluminum

Pandora 52 Bedside table P.44
DC634-2M-G4

Babele Bookcase P.80
DC635-3M-G4 / DC636-6M-E5

Wave Bench P.154
DC648-M10





Plissé

DIMENSIONS

 60/64,5 x 267 cm

WEIGHT

 from 7,4 to 15 kg/m²

THICKNESS

 Min. 60 mm

USAGE

Wall, Indoor/Outdoor

DATA SHEET P.390

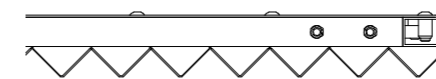

DESIGN BY R&D DE CASTELLI

The Plissé cladding system, inspired by Elizabeth furniture, features a succession of dense, uniform pleats. The special processing applied to predefined and modular panels gives life to a pleated covering that adds a touch of elegance to diverse surfaces. The interplay between rigour and sinuosity in the design creates a beautiful contrast.

La successione di pieghe fitte e regolari definisce il design del sistema di rivestimento Plissé ispirato agli arredi Elizabeth. La particolare lavorazione applicata a pannelli predefiniti e componibili dà vita ad un abito plissettato che può vestire svariate superfici in un gioco di contrasti che combina rigore e sinuosità.

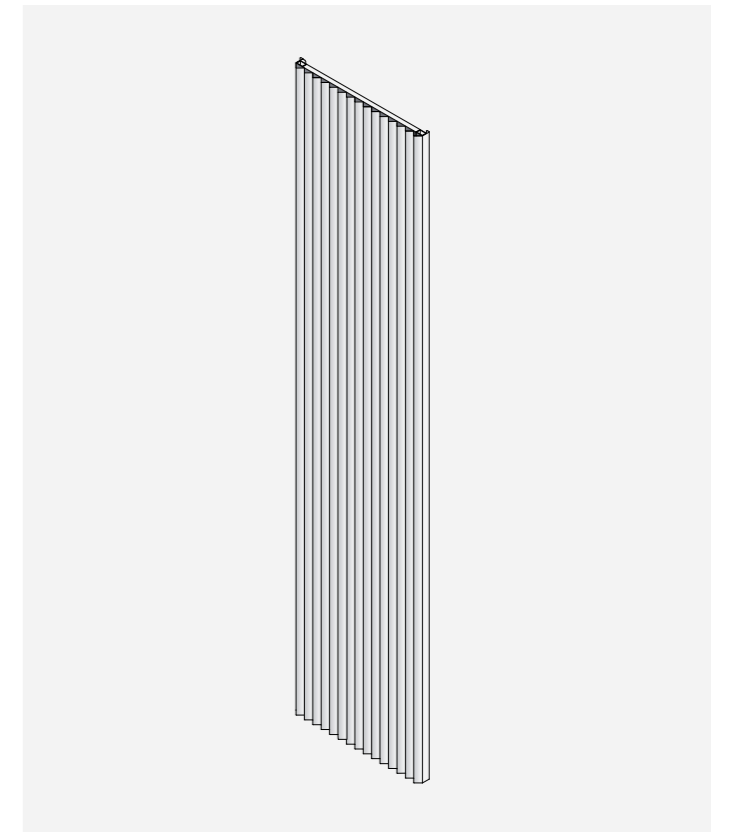

←
Plissé Covering DS717
Polished brass M14

Syro Mirrors P.238
DC620-G2 / DC619-G2 / DC618-G2

Elizabeth 180 Sideboard P.22
DC718-M13

Caravan 240 Sofa P.140
DC661-M11-AQ

Band 55 Coffee table P.164
DC640-E11

Plissé Cladding solution P.340
DS717-M10

Pensando ad Acapulco Chair P.148
DC514-M13



Vela

DIMENSIONS

 60/64,5 x 267 cm

WEIGHT

 from 17,4 to 18,5 kg/m²

THICKNESS

 Min 60 mm

USAGE

Wall, Indoor/Outdoor

DATA SHEET P.391

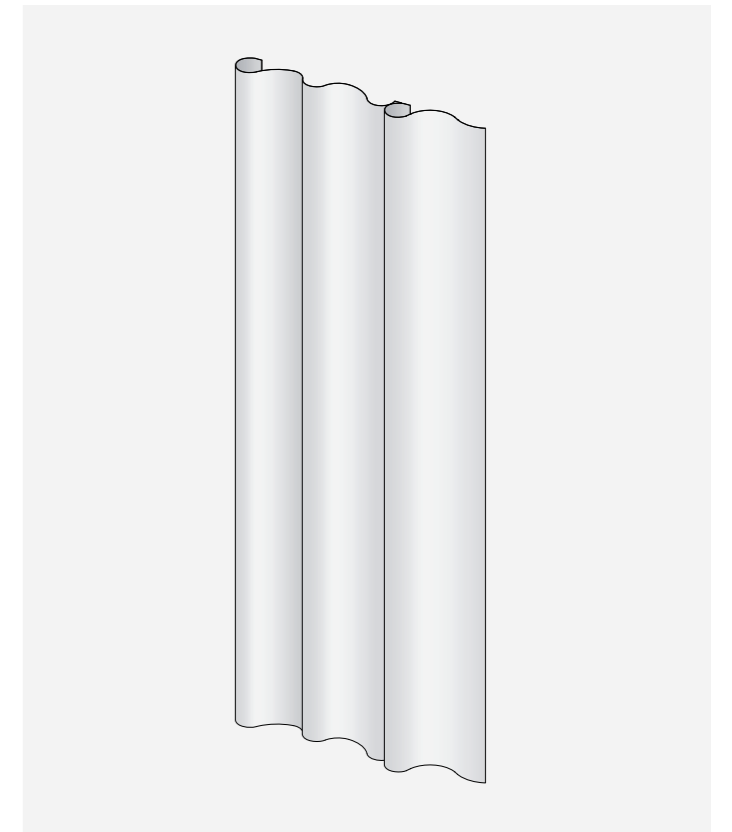
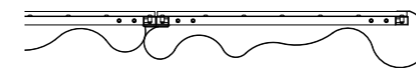

DESIGN BY GNOSIS PROGETTI

The Vela cladding system consists of pre-made and modular panels characterised by metal sheet worked in a way to mimic the visual effect of fabric blowing in the wind. The panels are skilfully shaped into gentle, light waves that evoke diverse reactions and emotions depending on the viewer's perspective, resulting in unusual and unexpected coverings.

Il sistema di rivestimento Vela prevede pannelli predefiniti e componibili caratterizzati da lastre in metallo lavorate come se fossero un tessuto mosso dal vento. Le onde morbide e leggere sapientemente plasmate provocano reazioni e percezioni emotive differenti a seconda della posizione dello spettatore dando vita a rivestimenti inusuali e inaspettati.

←
Vela Covering DS716
DeDarié stainless steel E7

Vela Cladding solution
DS716-M5

Boiserie Cladding solution P.327
Verdigris copper M5





Materioteca

Samples images are an indication only and do not replace the use of real ones when ordering, since it is impossible to guarantee a printed reproduction identical to the original. The images are sometimes zoomed to allow a better comprehension of the finishing.

Any differences between the finished product and supplied samples are not to be considered as defects, but as inherent characteristics deriving from the manual working process which may result in variations to the colour, finishing and homogeneity of the final product. It should also be remembered that metal can show tone variations from one batch to another. De Castelli assumes no responsibility in the event of any differences, in particular for products purchased at different times.

I campioni sono da considerarsi puramente indicativi, non essendo possibile garantire una riproduzione stampata che sia del tutto fedele all'originale, e non sostituiscono l'uso dei campionari reali in caso di ordine. Le immagini dei campioni sono a volte ingrandite o rimpicciolite per permettere una migliore visione della finitura.

Eventuali variazioni rispetto ad un campione in visione sono da considerarsi non come difetto, ma come caratteristica insita della lavorazione manuale che può essere suscettibile di variazioni di tonalità, ossidazione ed omogeneità. Si ricorda inoltre che il metallo può mostrare differenze di tonalità da una partita all'altra. De Castelli non si assume alcuna responsabilità in caso di eventuali differenze, in particolare per prodotti acquistati in tempi diversi.

Brass

- F1 Satin brass
Ottone satinato
- M9 Brushed brass
Ottone spazzolato
- E13 Polished brass
Ottone lucido
- F2 DeLabré brass
Ottone DeLabré
- G3 Orbitale DeLabré brass
Ottone DeLabré orbitale
- G7 Striped DeLabré brass
Ottone DeLabré striato
- M7 DeSalt brass
Ottone DeSalt
- M3 DeOpale brass
Ottone DeOpale
- M6 DeMarea brass
Ottone DeMarea
- M16 DeSatén brass
Ottone DeSatén
- G8 Hammered polished brass
Ottone martellato lucido
- F3 Bronzed DeMastral brass
Ottone DeMastral brunito
- H- DeErosion on brass
DeErosion su ottone
- L- DeGlyphé brass
Ottone DeGlyphé



Copper

- F5 Satin copper
Rame satinato
- M10 Brushed copper
Rame spazzolato
- G10 Brushed hammered copper
Rame martellato spazzolato
- E14 Polished copper
Rame lucido
- G5 DeLabré copper
Rame DeLabré
- G4 Orbitale DeLabré copper
Rame DeLabré orbitale
- G6 Striped DeLabré copper
Rame DeLabré striato
- M2 DeOpale copper
Rame DeOpale
- M17 DeSatén copper
Rame DeSatén
- M5 DeMarea copper
Rame DeMarea
- F8 Bronzed DeMastral copper
Rame DeMastral brunito
- F6 Mottled copper
Rame fiammato
- G11 Ruby copper
Rame rubino
- N1 Forest DeNuance copper
DeNuance foresta rame
- N10 Forest matt DeNuance copper
DeNuance foresta opaco rame
- N2 Ocean DeNuance copper
DeNuance oceano rame
- N20 Ocean matt DeNuance copper
DeNuance oceano opaco rame
- N30 Verdigris DeNuance copper
DeNuance verderame rame
- N4 Lagoon DeNuance copper
DeNuance laguna rame
- N40 Lagoon matt DeNuance copper
DeNuance laguna opaco rame
- F7 Verdigris copper
Verderame rame
- H- DeErosion on copper
DeErosion su rame

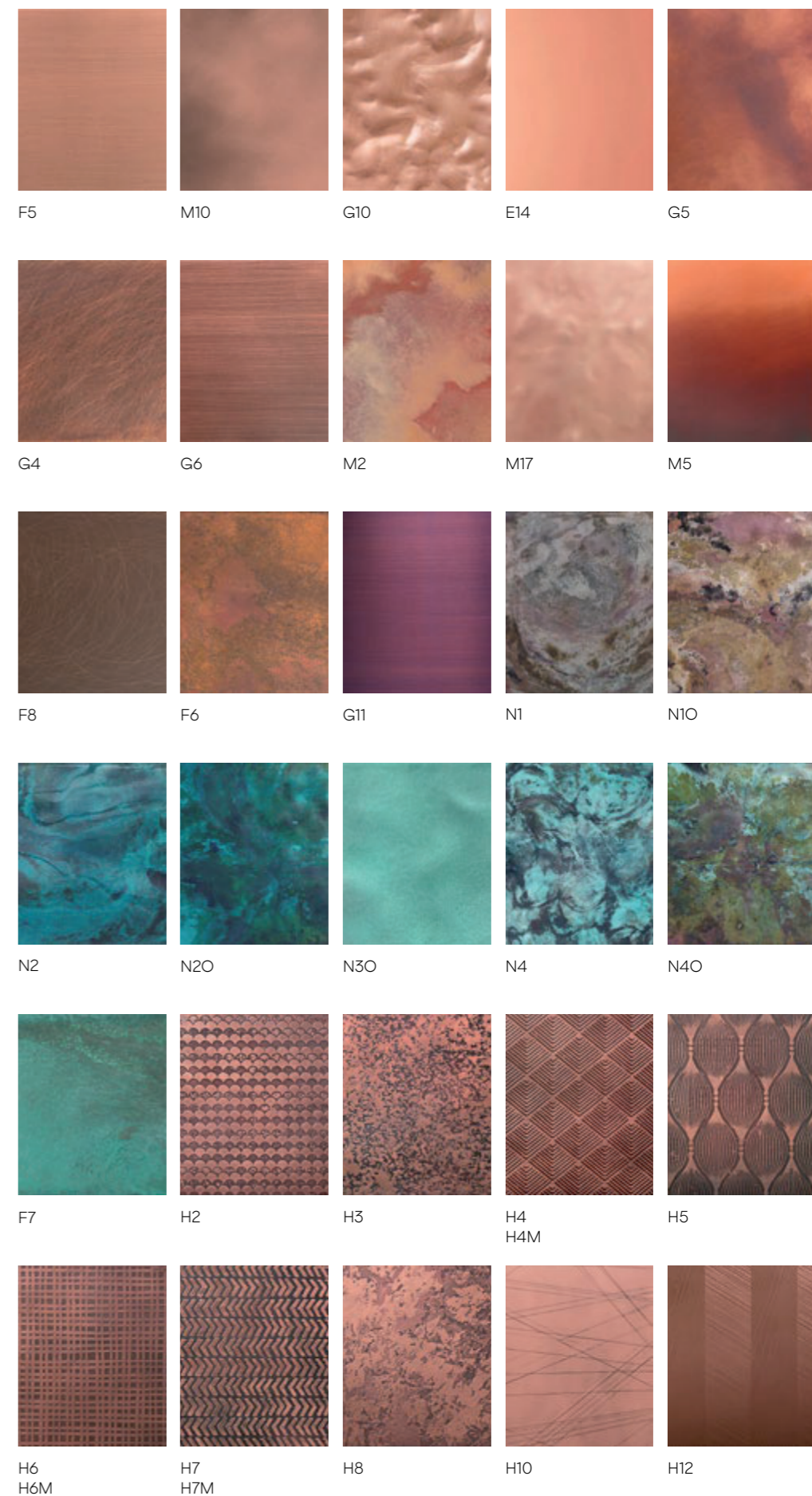

Stainless steel

- D1 Satin stainless steel
Acciaio inox satinato
- M11 Brushed stainless steel
Acciaio inox spazzolato
- D2 Polished stainless steel
Acciaio inox lucido
- G12 DeDeep stainless steel
Acciaio inox DeDeep
- M0 DeOpale stainless steel
Acciaio inox DeOpale
- E11 DeLabré stainless steel
Acciaio inox DeLabré
- G2 Orbitale DeLabré stainless steel
Acciaio inox DeLabré orbitale
- E6 Striped DeLabré stainless steel
Acciaio inox DeLabré striato
- M4 DeMarea stainless steel
Acciaio inox DeMarea
- E5 DeLabré B stainless steel
Acciaio inox DeLabré B
- E7 DeDarié stainless steel
Acciaio inox DeDarié
- E8 Noir Sablé
- E9 Maron Sablé
- D3 Bronzed DeMastral stainless steel
Acciaio inox DeMastral brunito
- D7 Waxed corten
Corten cerato
- M14 Polished brass finishing
Finitura ottone lucido
- M13 Polished copper finishing
Finitura rame lucido
- D8 Ral 9010
- H - DeErosion on stainless steel
DeErosion su acciaio inox

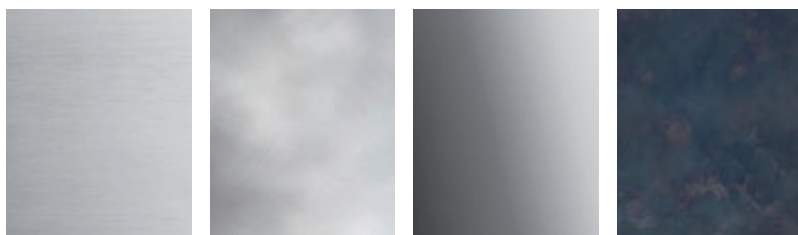

D1 M11 D2 G12



M0 E11 G2 E6



M4 E5 E7 E8



E9 D3 D7 M14

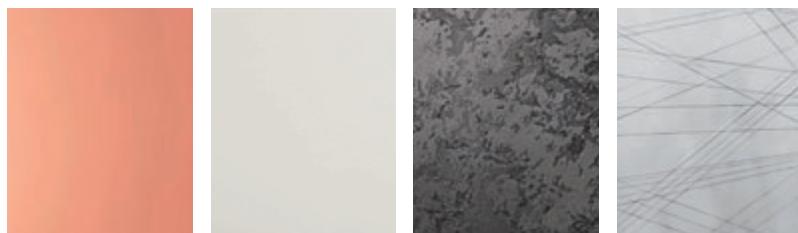

M13 D8 H8 H10

Data sheets

FURNITURE

355	Cabinets & Sideboards
362	Bookcases
364	Consoles
365	Tables
367	Seatings
369	Coffee Tables
373	Dividers
374	Lightings
376	Mirrors
377	Pots
381	Landscape

SURFACES

383	Tiles
385	Mosaics
387	Decorative
389	Cladding solutions

USEFUL INFORMATIONS

393	Cleaning and maintenance
394	Installation

Introduction to data sheets

Please check the price list for customisation options.
Every customization is subjected to confirmation by De Castelli.

Si prega di fare riferimento al listino prezzi per eventuali possibilità di personalizzazione. Ogni personalizzazione è soggetta a conferma da parte di De Castelli.

CANNETO BARISTA

PP. 6 | 78

Metal finishes	
Stainless steel	Brushed M11
Brass	Brushed M9
Copper	Brushed M10
Structure	
Canaletto walnut wood	
Assembly	
Shelves shipped disassembled	
Packaging	
Wooden cage included	
Details	
– Clad in metal on all sides	
– Internally clad in polished stainless steel	
– Book opening with hidden wheels at the bottom	
– Two glass shelves on the left side and three on the right side included	

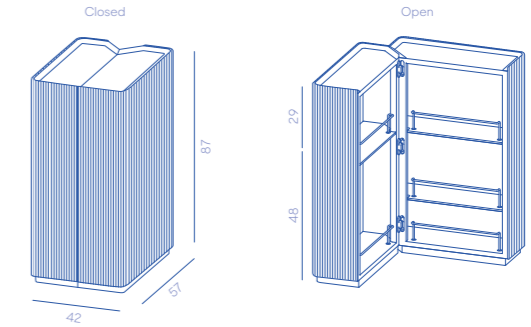

Canneto Barista
DC668 / Weight 78 kg

CANNETO CABINET

PP. 6 | 10

Metal finishes	
Stainless steel	Brushed M11
Brass	Brushed M9
Copper	Brushed M10
Structure	
Canaletto walnut wood	
Assembly	
Shelves shipped disassembled	
Packaging	
Wooden cage included	
Details	
– Clad in metal on all sides	
– Two "L" doors with 90° opening	
– Fixed inner shelves and divider as per drawings	

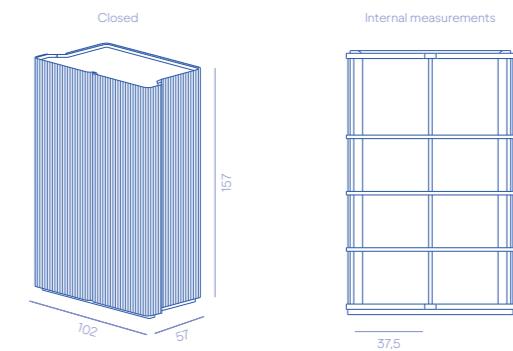

Canneto Cabinet
DC674 / Weight 205 kg

CANNETO FLOOR CONSOLE

PP. 6

Metal finishes	
Stainless steel	Brushed M11
Brass	Brushed M9
Copper	Brushed M10
Structure	
Canaletto walnut wood	
Assembly	
Shipped assembled	
Packaging	
Wooden cage included	
Details	
– Clad in metal on all sides	
– Two doors opening	
– Two side doors opening and two central drawers with an inner drawer each	
– Pull opening with full-extension Blumotion	
– Movento slides by Blum	

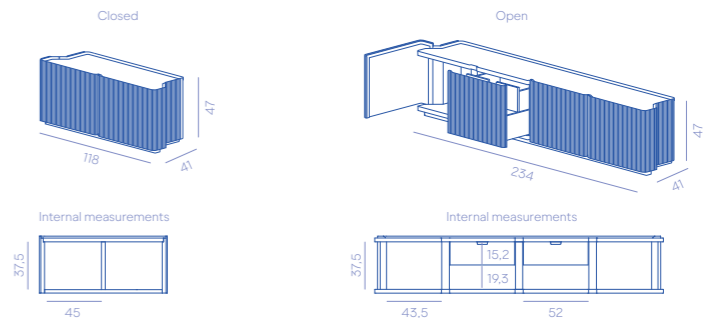

Canneto floor Console 118
DC688T / Weight 65 kg

Canneto floor Console 234
DC673T / Weight 130 kg

CANNETO WALL MOUNTED CONSOLE

PP. 6 | 218

Metal finishes	
Stainless steel	Brushed M11
Brass	Brushed M9
Copper	Brushed M10
Structure	
Canaletto walnut wood	
Assembly	
Shipped assembled	
Packaging	
Wooden cage included	
Details	
– Clad in metal on all sides, except the back	
– Load-bearing wall or reinforced plasterboard is required	
– Wall fixing system included, fixing screws excluded	
– Two doors opening	
– Two side doors opening and two central drawers with an inner drawer each	
– Pull opening with full-extension Blumotion	
– Movento slides by Blum	

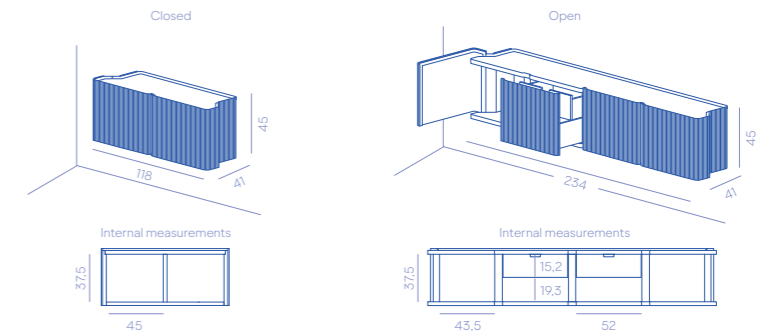

Canneto wall mounted Console 118
DC688 / Weight 65 kg

Canneto wall mounted Console 234
DC673 / Weight 130 kg

CELATO BED SIDE TABLE

PP. 12

Metal finishes	
Stainless steel	DeLabré B E5, DeDarié E7, orbitale DeLabré G2, striped DeLabré E6
Brass	DeLabré F2, orbitale DeLabré G3, striped DeLabré G7
Copper	DeLabré G5, orbitale DeLabré G4, striped DeLabré G6
Structure	
	Natural birch wood
Assembly	
	Shipped assembled
Packaging	
	Wooden cage included
Details	
	– Clad in metal on all sides
	– Hidden drawers as per drawings
	– Push and pull opening with full-extention Movento slides by Blum

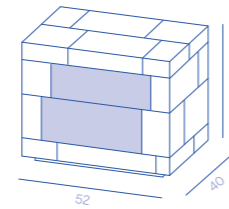

Celato 45
DC347 / Weight 37 kg

CELATO CHEST OF DRAWERS

PP. 12 | 16, 17, 138, 158

Metal finishes	
Stainless steel	DeLabré B E5, DeDarié E7, orbitale DeLabré G2, striped DeLabré E6
Brass	DeLabré F2, orbitale DeLabré G3, striped DeLabré G7
Copper	DeLabré G5, orbitale DeLabré G4, striped DeLabré G6
Structure	
	Natural birch wood
Assembly	
	Shipped assembled
Packaging	
	Wooden cage included
Details	
	– Clad in metal on all sides
	– Hidden drawers as per drawings
	– Push and pull opening with full-extention Movento slides by Blum
	– Equipped with hidden secretaire by removing the drawer at the bottom

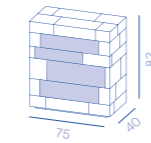

Celato 80
DC345 / Weight 54 kg

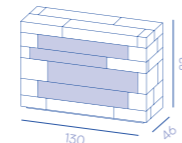

Celato 130
DC346 / Weight 100 kg

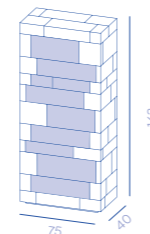

Celato 160
DC343 / Weight 102 kg

CELATO FLOOR CONSOLE

PP. 12 | 20, 120

Metal finishes	
Stainless steel	DeLabré B E5, DeDarié E7, orbitale DeLabré G2, striped DeLabré E6
Brass	DeLabré F2, orbitale DeLabré G3, striped DeLabré G7
Copper	DeLabré G5, orbitale DeLabré G4, striped DeLabré G6
Structure	
	Natural birch wood
Assembly	
	Shipped assembled
Packaging	
	Wooden cage included
Details	
	– Clad in metal on all sides
	– Hidden drawers as per drawings
	– Push and pull opening with full-extention Movento slides by Blum

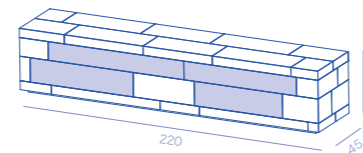

Celato floor Console
DC349 / Weight 139 kg

CELATO WALL MOUNTED CONSOLE

PP. 12

Metal finishes	
Stainless steel	DeLabré B E5, DeDarié E7, orbitale DeLabré G2, striped DeLabré E6
Brass	DeLabré F2, orbitale DeLabré G3, striped DeLabré G7
Copper	DeLabré G5, orbitale DeLabré G4, striped DeLabré G6
Structure	
	Natural birch wood
Assembly	
	Shipped assembled
Packaging	
	Wooden cage included
Details	
	– Clad in metal on all sides, except the back
	– Hidden drawers as per drawings
	– Push and pull opening with full-extention Movento slides by Blum
	– Wall fixing system included, fixing screws excluded
	– Load-bearing wall or reinforced plasterboard is required

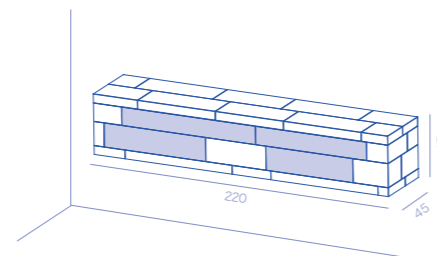

Celato Wall mounted Console
DC348 / Weight 139 kg

ELIZABETH CONSOLE

PP. 22 | 26, 96

Metal finishes	
Stainless steel	Polished D2
Brass	Polished M14
Copper	Polished M13
Structure	
	Matt lacquered RAL 7013 wood
Assembly	
	Shipped assembled
Packaging	
	Wooden cage included
Details	
	– Clad in plated metal on all sides
	– Two push and pull opening doors
	– Fixed shelf and divider

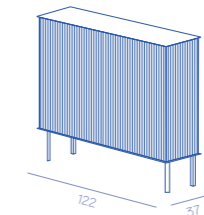

Elizabeth Console
DC541 / Weight 90 kg

Internal measurements

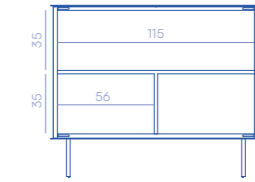

ELIZABETH SIDEBOARD

PP. 22 | 27, 342

Metal finishes	
Stainless steel	Polished D2
Brass	Polished M14
Copper	Polished M13
Structure	
	Matt lacquered RAL 7013 wood
Assembly	
	Shipped assembled
Packaging	
	Wooden cage included
Details	
	– Clad in plated metal on all sides
	– Push and pull opening doors
	– Movable shelves

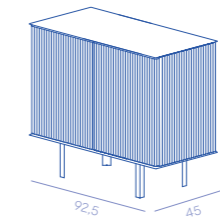

Elizabeth sideboard 92
DC716 / Weight 90 kg

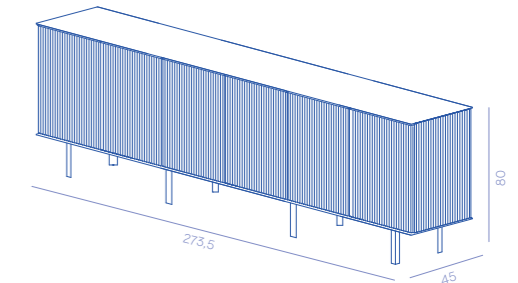

Elizabeth sideboard 273
DC718 / Weight 270 kg

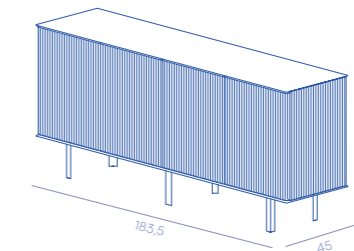

Elizabeth sideboard 183
DC717 / Weight 180 kg

Internal measurements

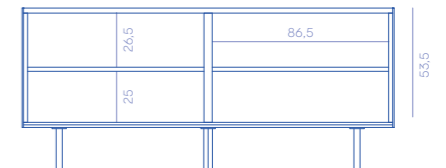

GRAFFIO

P. 28 | 31

Metal finishes	
Stainless steel	DeErosion H10
Brass	DeErosion H10
Copper	DeErosion H10
Structure	
	Natural oak wood
Assembly	
	Shipped assembled
Packaging	
	Wooden cage included
Details	
	– Clad in metal on all sides, except the back
	– Two pull opening doors equipped with three shelves and three bottle holders each
	– Two fixed shelves
	– Two inner drawers with pull opening with full-extention Blumotion Movento slides by Blum

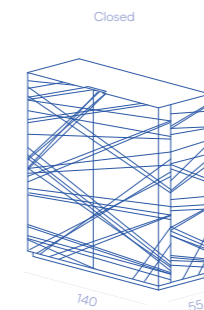

Graffio
DC639 / Weight 160 kg

Open

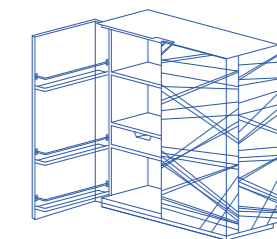

Internal measurements

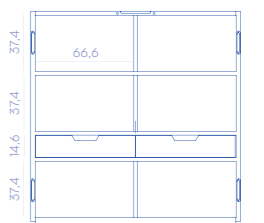

LONGING CABINET

P. 32

Metal finishes	Brass MIX Copper MIX
Structure	Matt lacquered RAL 3012 wood
Assembly	Shipped assembled
Packaging	Wooden cage included
Details	- Clad in metal on all sides in different finishes as per photo - Sixteen doors opening equipped with keys made of cast brass

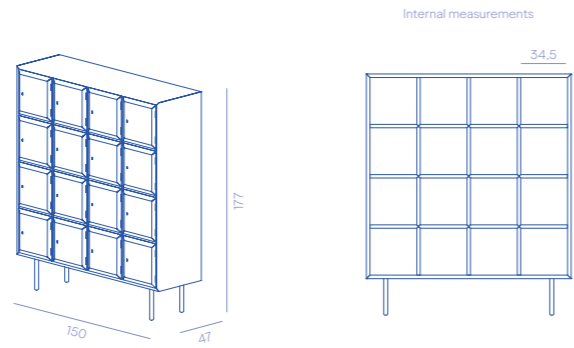

Longing Cabinet
DC5511 / Weight 120 kg

MAREA CABINET

PP. 34 | 235

Metal finishes	Stainless steel DeLabré B E5, orbitale DeLabré G2, DeMarea M4 Brass DeLabré F2, orbitale DeLabré G3, DeMarea M6 Copper DeLabré G5, orbitale DeLabré G4, DeMarea M5
Structure	Titanium oak wood
Assembly	Shelves shipped disassembled
Packaging	Wooden cage included
Details	- Clad in metal on all sides - Push and pull doors opening - Equipped with a central fixed shelf and two other movable shelves - Inside door-straightener included

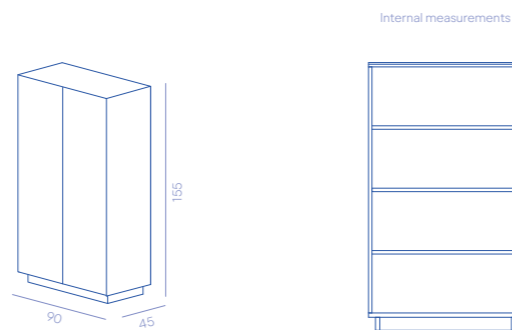

Marea Cabinet
DC605 / Weight 94 kg

MAREA SIDEBOARD

PP. 34 | 38, 236

Metal finishes	Stainless steel DeLabré B E5, orbitale DeLabré G2, DeMarea M4 Brass DeLabré F2, orbitale DeLabré G3, DeMarea M6 Copper DeLabré G5, orbitale DeLabré G4, DeMarea M5
Structure	Titanium oak wood
Assembly	Shipped assembled
Packaging	Wooden cage included
Details	- Clad in metal on all sides - Push and pull doors opening - Equipped with 1 movable shelf

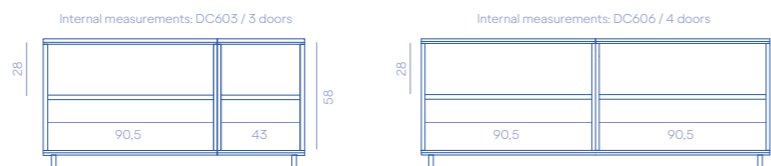
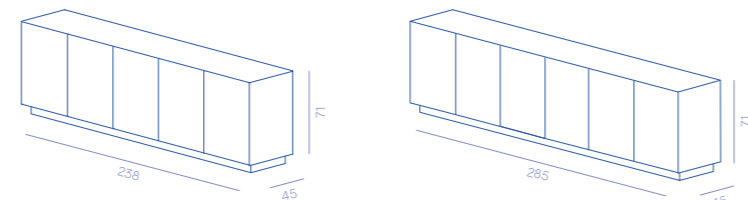
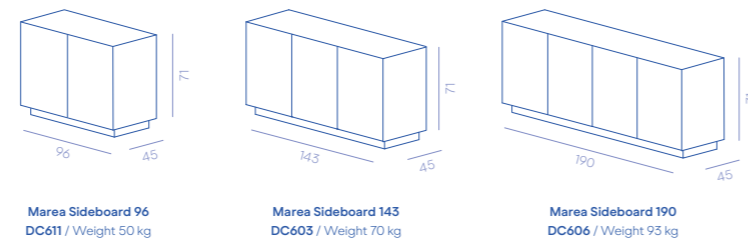

MAREA DRESSER

PP. 34 | 171

Metal finishes	Stainless steel DeLabré B E5, orbitale DeLabré G2, DeMarea M4 Brass DeLabré F2, orbitale DeLabré G3, DeMarea M6 Copper DeLabré G5, orbitale DeLabré G4, DeMarea M5
Structure	Titanium oak wood
Assembly	Shipped assembled
Packaging	Wooden cage included
Details	- Clad in metal on all sides - Push and pull drawers opening with full-extension Movento slides by Blum

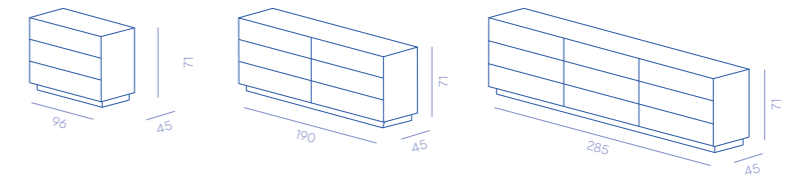

Marea Dresser 96 DC643 / Weight 60 kg
Marea Dresser 190 DC644 / Weight 115 kg
Marea Dresser 285 DC645 / Weight 170 kg

MAREA CHEST OF DRAWERS

PP. 34 | 75

Metal finishes	Stainless steel DeLabré B E5, orbitale DeLabré G2, DeMarea M4 Brass DeLabré F2, orbitale DeLabré G3, DeMarea M6 Copper DeLabré G5, orbitale DeLabré G4, DeMarea M5
Structure	Titanium oak wood
Assembly	Shipped assembled
Packaging	Wooden cage included
Details	- Clad in metal on all sides - Push and pull drawers opening with full-extension Movento slides by Blum

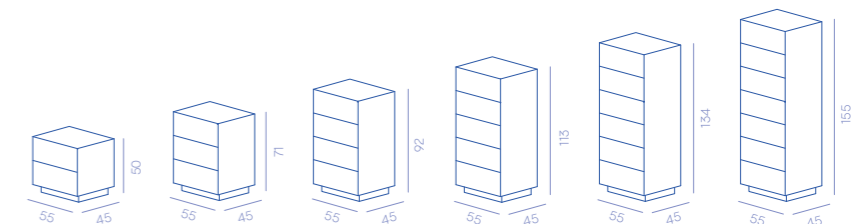

Marea Drawers 50 DC614 Weight 26 kg
Marea Drawers 71 DC613 Weight 36 kg
Marea Drawers 92 DC616 Weight 46 kg
Marea Drawers 113 DC607 Weight 63 kg
Marea Drawers 134 DC615 Weight 76 kg
Marea Drawers 155 DC612 Weight 90 kg

MIDA

PP. 42 | 49, 120

Metal finishes	Stainless steel DeLabré E11, DeOpale M0, DeErosion H8 Brass DeLabré F2, DeOpale M3, DeErosion H8 Copper DeLabré G5, DeOpale M2, DeErosion H8
Structure	Internal Matt lacquered RAL 7016 wood Outer shell Clad in orbitale DeLabré stainless steel G2
Assembly	Shipped assembled
Packaging	Wooden cage included
Details	- Load-bearing wall or reinforced plasterboard is required - Wall fixing system included. Fixing screws excluded. - Left sliding door opening - Right sliding door opening

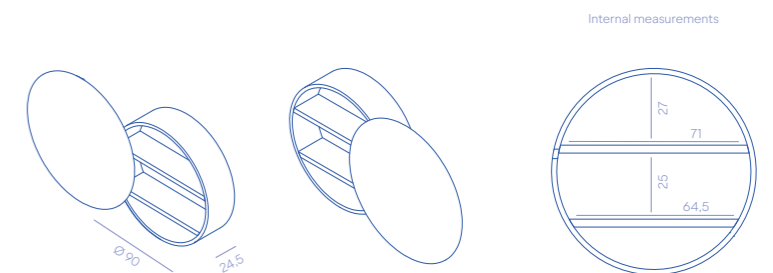

Mida Cabinet left DC601 / Weight 44 kg
Mida Cabinet right DC602 / Weight 44 kg

PANDORA

PP. 44 | 47, 48, 338

Metal finishes	Stainless steel DeLabré B E5, DeDarié E7, orbitale DeLabré G2 Brushed M9, DeLabré F2, orbitale DeLabré G3 Copper Brushed M10, DeLabré G5, orbitale DeLabré G4
Structure	Natural oak wood
Assembly	Shipped assembled
Packaging	Wooden cage included
Details	- Clad in metal on all sides - Hidden drawers as per drawing - Push and pull opening with full-extension Movento slides by Blum - Aligned drawers opening upon request

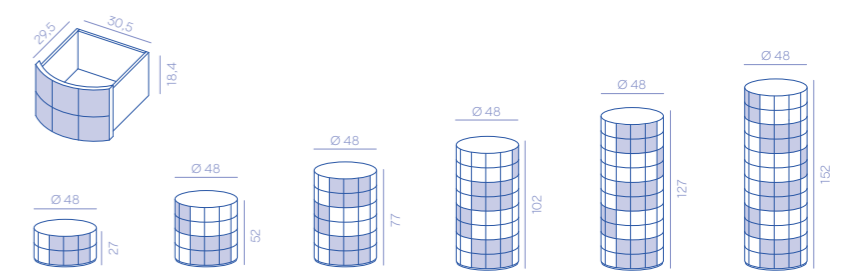

Pandora 27 DC634-1M Weight 23 kg
Pandora 52 DC634-2M Weight 42 kg
Pandora 77 DC634-3M Weight 60 kg
Pandora 102 DC634-4M Weight 77 kg
Pandora 127 DC634-5M Weight 96 kg
Pandora 152 DC634-6M Weight 115 kg

POLIFEMO

P. 50

Metal finishes	
Brass	Brushed M9
Copper	Brushed M10
Structure	
Internal wood	Matt lacquered RAL 7016 wood
Legs	DeLabré B stainless steel E5
Assembly	
Shipped assembled	
Packaging	
Wooden cage included	
Details	
<ul style="list-style-type: none"> - Clad in metal on all sides, except the back - Two fixed shelves - Wall fixing is highly recommended - Load-bearing wall or reinforced plasterboard is required - Wall fixing system included, fixing screws excluded 	

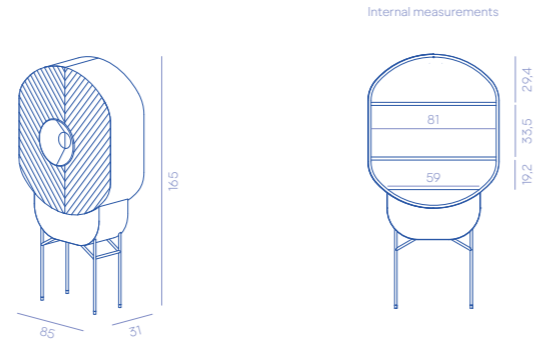

Polifemo
DC550 / Weight 55 kg

RIPPLE

P. 52 | 54

Metal finishes	
Stainless steel	Brushed M11, DeLabré B E5, orbitale DeLabré G2
Brass	Brushed M9, orbitale DeLabré G3
Copper	Brushed M10, orbitale DeLabré G4
Structure	
Matt lacquered RAL 7016 wood	
Assembly	
Shipped assembled	
Packaging	
Wooden cage included	
Details	
<ul style="list-style-type: none"> - Clad in metal on all sides - Two hidden doors with 180° push and pull opening - Equipped with 3 fixed shelves per side 	

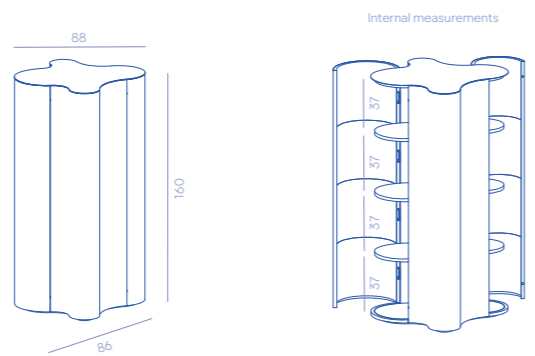

Ripple
DC696 / Weight 160 kg

SCULPT

PP. 56 | 58, 228

Metal finishes	
Brass	De Satèn M16
Copper	De Satèn M17
Structure	
Matt lacquered RAL 7024 wood	
Assembly	
Shipped assembled	
Packaging	
Wooden cage included	
Details	
<ul style="list-style-type: none"> - Clad in metal on all sides - Domed sides and doors entirely made of metal with 45° folding and push and pull opening - Equipped with one central fixed shelf 	

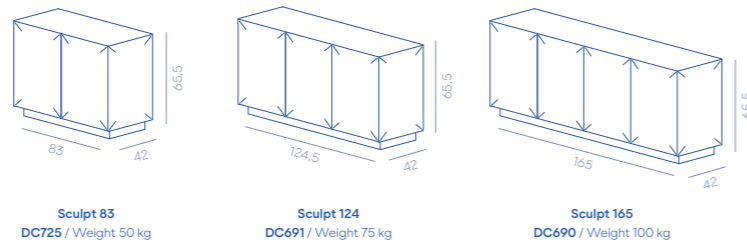

Sculpt 83
DC725 / Weight 50 kg

Sculpt 124
DC691 / Weight 75 kg

Sculpt 165
DC690 / Weight 100 kg

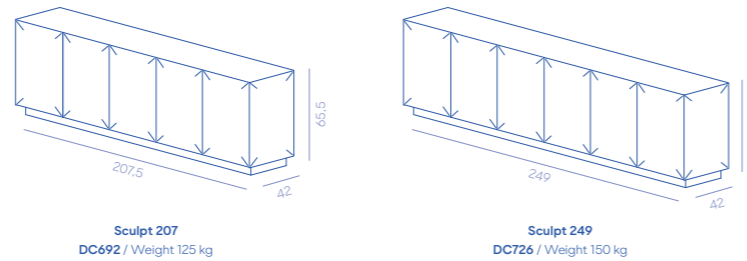

Sculpt 207
DC692 / Weight 125 kg

Sculpt 249
DC726 / Weight 150 kg

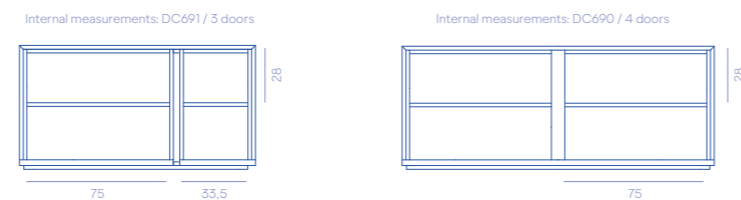

TAKO FLOOR CONSOLE

P. 60

Metal finishes	
Stainless steel	DeLabré B E5
Brass	DeLabré F2, DeErosion H2/H3/H4/H6/H7/H8
Copper	DeLabré G5, DeErosion H2/H3/H4/H6/H7/H8
Structure	
Natural oak wood	
Assembly	
Shipped assembled	
Packaging	
Wooden cage included	
Details	
<ul style="list-style-type: none"> - Clad in metal on all sides, except the back - Top and sides always clad in DeLabré B stainless steel E5 - Pull drawer opening with full-extension Blumotion Movento slides by Blum 	

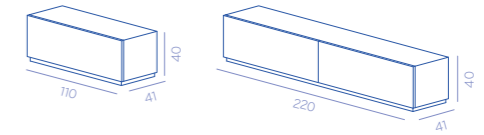

Tako Floor console 110
DC638T / Weight 45 kg

Tako Floor console 220
DC637T / Weight 95 kg

TAKO WALL MOUNTED CONSOLE

PP. 60 | 62, 209

Metal finishes	
Stainless steel	DeLabré B E5
Brass	DeLabré F2, DeErosion H2/H3/H4/H6/H7/H8
Copper	DeLabré G5, DeErosion H2/H3/H4/H6/H7/H8
Structure	
Natural oak wood	
Assembly	
Shipped assembled	
Packaging	
Wooden cage included	
Details	
<ul style="list-style-type: none"> - Clad in metal on all sides, except the back - Top, bottom and sides always clad in DeLabré B stainless steel E5 - Pull drawer opening with full-extension Blumotion Movento slides by Blum - Load-bearing wall or reinforced plasterboard is required - Wall fixing system included, fixing screws excluded 	

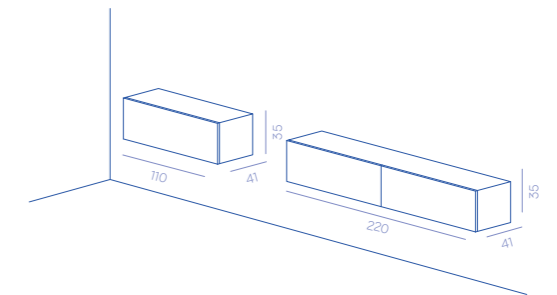

Tako wall mounted Console 110
DC638 / Weight 45 kg

Tako wall mounted Console 220
DC637 / Weight 95 kg

XILO CONSOLE

P. 66

Metal finishes	
Stainless steel	DeLabré B E5, orbitale DeLabré G2, MIX
Brass	DeLabré F2, orbitale DeLabré G3, MIX
Copper	DeLabré G5, orbitale DeLabré G4, MIX
Structure	
Matt lacquered RAL 7024 wood	
Assembly	
Shipped disassembled	
Packaging	
Wooden cage included	
Details	
<ul style="list-style-type: none"> - Clad in metal on all sides, except the back - Pull door opening - Equipped with inner drawer with pull opening - Load-bearing wall or reinforced plasterboard is required - Wall fixing system included, fixing screws excluded 	

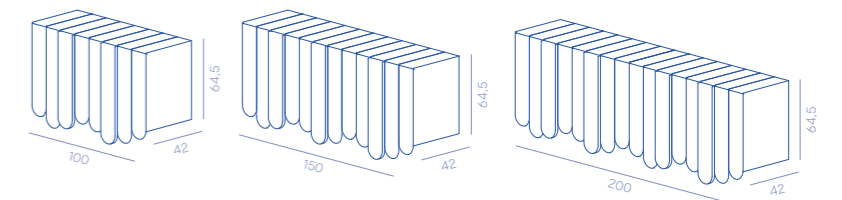

Xilo Console 100
DC705 / Weight 50 kg

Xilo Console 150
DC706 / Weight 75 kg

Xilo Console 200
DC707 / Weight 100 kg

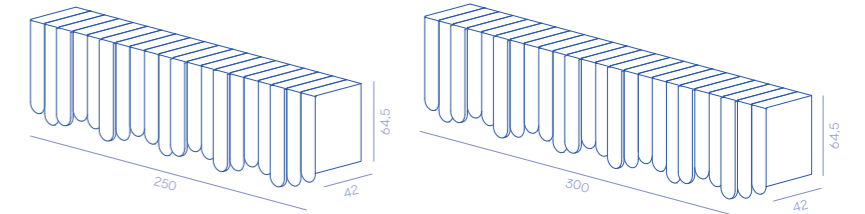

Xilo Console 250
DC708 / Weight 125 kg

Xilo Console 300
DC709 / Weight 150 kg

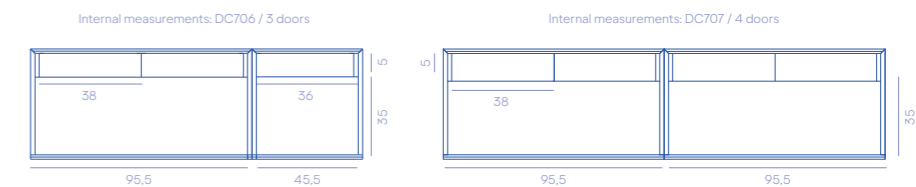

YOROI PP. 70 | 74, 150

Metal finishes	Stainless steel DeLabré B E5, DeDarié E7, orbitale DeLabré G2 Brass DeLabré F2, orbitale DeLabré G3 Copper DeLabré G5, orbitale DeLabré G4
Structure	Natural oak wood
Assembly	Shipped assembled
Packaging	Wooden cage included
Details	- Clad in metal on all sides - Two pull doors opening - Inner shelf per side - Equipped with one big drawer and two small inclined drawers with push and pull opening

Yoroï
DC510 / Weight 128 kg

AIRFRAME P. 76 | 78

Metal finishes	Brass Brushed M9
Assembly	Shipped assembled
Packaging	Wooden cage included
Details	- Self standing bookcase/divider entirely made of brass with four shelves, partially covered with handmade hammered metal sheets - Equipped with a ballast at the base to increase stability

Airframe
DC695 / Weight 130 kg

BABELE PP. 80 | 116, 338

Metal finishes	Stainless steel DeLabré B E5 Brass Brushed M9, orbitale DeLabré G3, DeSalt M7 Copper Brushed M10, orbitale DeLabré G4
Structure	DeLabré M12
Assembly	The product is shipped assembled up to three modules. Starting from the fourth module, the product is delivered in two or more cages and assembly is required.
Packaging	Wooden cage not included, available upon request to be quoted at order confirmation
Details	- Free standing bookcase entirely made of metal - Equipped with a ballast at the base to increase stability - Starting from 130 cm heights, the wall fixing system included is highly recommended

Babele 28 3 shelves DC635-3M Weight 21 kg
Babele 28 4 shelves DC635-4M Weight 23 kg
Babele 28 5 shelves DC635-5M Weight 26 kg
Babele 28 6 shelves DC635-6M Weight 27.5 kg
Babele 28 7 shelves DC635-7M Weight 29.5 kg
Babele 28 8 shelves DC635-8M Weight 31 kg

Babele 36 2 shelves DC636-2M Weight 29.5 kg
Babele 36 3 shelves DC636-3M Weight 32 kg
Babele 36 4 shelves DC636-4M Weight 35 kg
Babele 36 5 shelves DC636-5M Weight 37.5 kg
Babele 36 6 shelves DC636-6M Weight 40 kg

EXISTENCE ROUND P. 84

Metal finishes	Stainless steel DeLabré B E5 Brass Orbitale DeLabré G3
Assembly	Shipped disassembled
Packaging	Open wooden cage included
Details	- Free standing bookcase entirely made of metal - Order installation from bottom to top

1 floor DC321 Weight 36 kg
2 floor DC322 Weight 63 kg
3 floor DC323 Weight 86 kg
4 floor DC324 Weight 120 kg
5 floor DC325 Weight 165 kg
6 floor DC326 Weight 180 kg
7 floor DC327 Weight 190 kg

EXISTENCE WALL PP. 84 | 87, 124

Metal finishes	Stainless steel DeLabré B E5 Brass Orbitale DeLabré G3
Assembly	Shipped disassembled
Packaging	Open wooden cage included
Details	- Wall-mounted bookcase entirely made of metal - Load-bearing wall or reinforced plasterboard is required - Wall fixing system included, fixing screws excluded - Order installation from bottom to top

1 floor DC328 Weight 50 kg
2 floor DC329 Weight 82 kg
3 floor DC330 Weight 117 kg
4 floor DC331 Weight 150 kg
5 floor DC332 Weight 185 kg

NAMI PP. 88 | 138

Metal finishes	Stainless steel Striped DeLabré E6 Brass Striped DeLabré G7 Copper Striped DeLabré G6
Structure	Striped DeLabré stainless steel E6
Assembly	Shipped assembled
Packaging	Wooden cage included
Details	- C-shape self standing bookcase entirely made of metal

Nami
DC489 / Weight 200 kg

NIPPON P. 92

Metal finishes	Iron Waxed natural black E3, DeLabré G1 Stainless steel DeLabré B E5 Brass Orbitale DeLabré G3
Assembly	Shipped assembled
Packaging	Wooden cage not included, available upon request to be quoted at order confirmation
Details	- Wall bookcase entirely made of metal - The wall fixing system included is highly recommended

Nippon
DC488 / Weight 143 kg

TALEA

Metal finishes	
Stainless steel	Orbitale DeLabré G2
Brass	Orbitale DeLabré G3
Copper	Orbitale DeLabré G4
Shelf	
	Gabon ebony
Assembly	
	Shipped disassembled
Packaging	
	Wooden cage included
Details	
	<ul style="list-style-type: none"> - Modular bookcase with metal uprights - Weight capacity 30kg each shelf - Load-bearing wall and ceiling or reinforced plasterboard is required - Wall fixing system included, fixing screws excluded

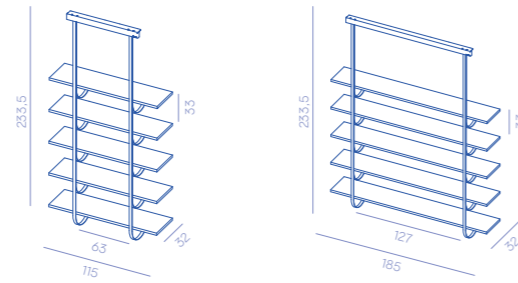

Talea 115
DC650 / Weight 48 kg

Talea 185
DC651 / Weight 70 kg

CONVIVIUM CONSOLE

Metal finishes	
Brass	Orbitale DeLabré G3, DeErosion H3
Assembly	
	Shipped assembled
Packaging	
	Wooden cage included
Details	
	<ul style="list-style-type: none"> - Console entirely made of brass - Load-bearing wall or reinforced plasterboard is required - Wall fixing system included. Fixing screws excluded

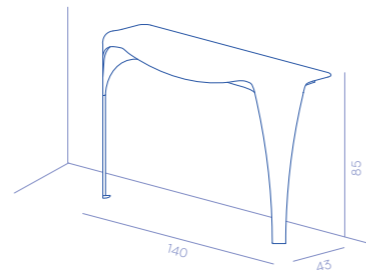

Convivium Console
DC529 / Weight 88 kg

EXISTENCE CONSOLE

Metal finishes	
Stainless steel	DeLabré B E5
Brass	Orbitale DeLabré G3
Copper	Orbitale DeLabré G4
Assembly	
	Shipped assembled
Packaging	
	Open wooden cage included
Details	
	<ul style="list-style-type: none"> - Suspended console entirely made of metal equipped with compartments of different sizes - Load-bearing wall or reinforced plasterboard is required - Wall fixing system included. Fixing screws excluded

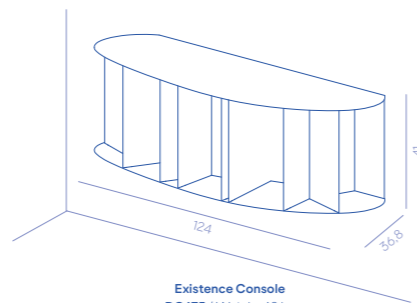

Existence Console
DC675 / Weight 48 kg

FOLIO CONSOLE

Metal finishes	
Stainless steel	DeMarea M4
Brass	DeMarea M6
Copper	DeMarea M5
Assembly	
	Shipped assembled
Packaging	
	Wooden cage included
Details	
	<ul style="list-style-type: none"> - Console entirely made of metal - Load-bearing wall or reinforced plasterboard is required - Wall fixing system included, fixing screws excluded - Protective film included on top

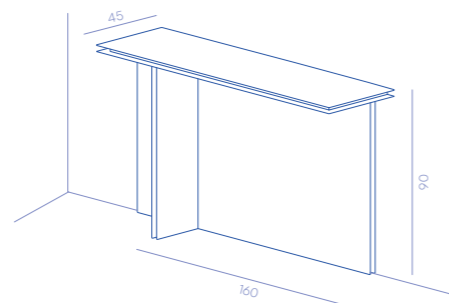

Folio Console
DC699 / Weight 100 kg

SINESTESIA

Metal finishes	
Stainless steel	DeErosion H11
Brass	DeErosion H11
Copper	DeErosion H11
Assembly	
	Shipped assembled
Packaging	
	Open wooden cage included
Details	
	<ul style="list-style-type: none"> - Self standing console entirely made of metal - It features the concave side in brushed finishing, the convex side in DeErosion H11 - It can be positioned by choosing the visible side as desired

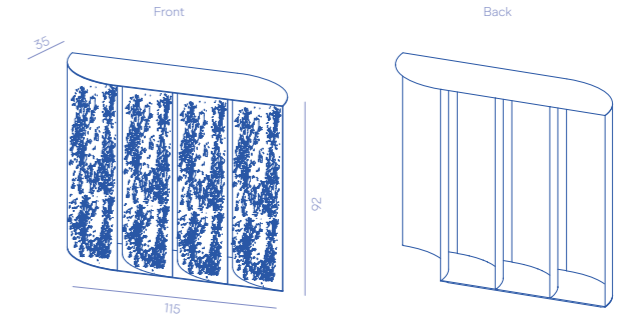

Sinestia
DC693 / Weight 73 kg

BAIA

Metal finishes	
Copper	DeNuance forest N1, DeNuance ocean N2, DeNuance lagoon N4, matt DeNuance forest N10, matt DeNuance ocean N20, matt DeNuance lagoon N40
Legs	
	Brushed copper M10, DeLabré B stainless steel E5, matt lacquered stainless steel M15
Assembly	
	Shipped disassembled
Packaging	
	Wooden cage included
Details	
	<ul style="list-style-type: none"> - Sculptural table with two cylindrical legs - Legs and top finishes can be combined as desired

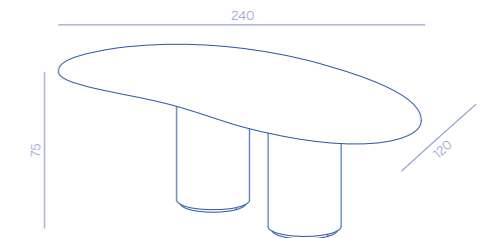

Baia
DC667 / Weight 145 kg

BURRACO TABLE

Metal finishes	
Copper	Brushed M10
Assembly	
	Shipped assembled
Packaging	
	Wooden cage included
Details	
	<ul style="list-style-type: none"> - Round game table with a copper top characterized by game seeds decoration in DeErosion technique - Equipped with four retractable cup holders

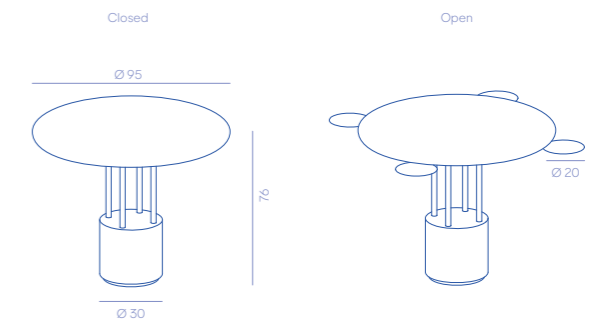

Burraco Table
DC646 / Weight 90 kg

BURRACO POUF

Metal finishes	
Copper	Brushed M10
Assembly	
	Shipped assembled
Packaging	
	Wooden cage not included, available upon request to be quoted at order confirmation
Details	
	<ul style="list-style-type: none"> - Green velvet - Minimum order 4 pieces

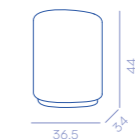

Burraco Pouf
DC647 / Weight 5 kg

CONVIVIUM TABLE

PP. 114 | 59, 117

Metal finishes	Brass DeErosion H3
Assembly	Shipped assembled
Packaging	Wooden cage included
Details	- Sculptural table entirely made of brass

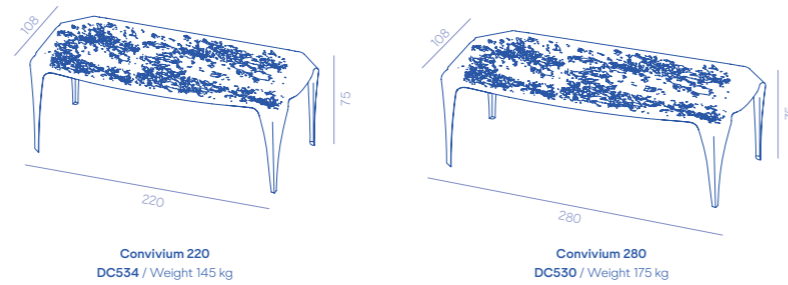

Convivium 220
DC534 / Weight 145 kg

Convivium 280
DC530 / Weight 175 kg

COSTE

P. 118 | 120

Metal finishes	Stainless steel Brushed M11 Brass Brushed M9 Copper Brushed M10
Top	DeDeep stainless steel G12
Assembly	DC678 Shipped assembled DC677/DC676 Shipped disassembled
Packaging	Wooden cage included
Details	- Top made in matt lacquered RAL 9004 MDF clad in stainless steel - Protective film included on top - Top made of one metal sheet DC678 DC677/DC676 - Top made of three metal sheets

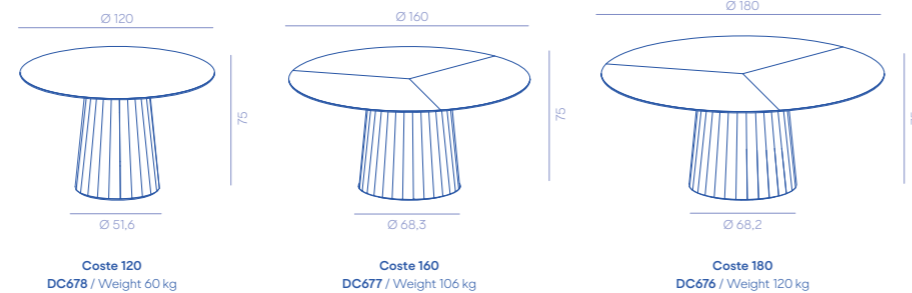

Coste 120
DC678 / Weight 60 kg

Coste 160
DC677 / Weight 106 kg

Coste 180
DC676 / Weight 120 kg

FOLIO TABLE

P. 122 | 124

Metal finishes	Stainless steel DeMarea M4, DeDeep G12 Brass DeMarea M6
Assembly	Shipped disassembled
Packaging	Wooden cage included
Details	- Table entirely made of 2 mm thick metal sheets coupled spaced apart by wooden structure clad in metal - Protective film included on top

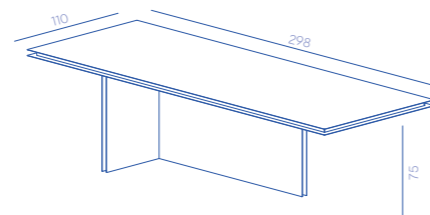

Folio Table
DC698 / Weight 238 kg

FOLIO TABLE ROUND

P. 122

Metal finishes	Stainless steel DeMarea M4, DeDeep G12 Brass DeMarea M6
Assembly	Shipped disassembled
Packaging	Wooden cage included
Details	- Table entirely made of 2 mm thick metal sheets coupled spaced apart by wooden structure clad in metal - Protective film included on top

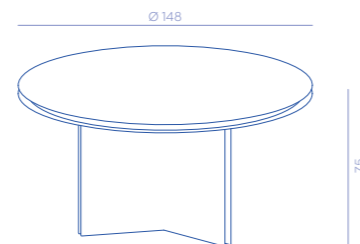

Folio Table round
DC700 / Weight 160 kg

PLATEAUX OF MIRROR

P. 128 | 130

Metal finishes	Stainless steel DeLabré B E5, orbitale DeLabré G2
Assembly	Shipped disassembled
Packaging	Wooden cage included
Details	- Table entirely made of metal - Protective film included on top

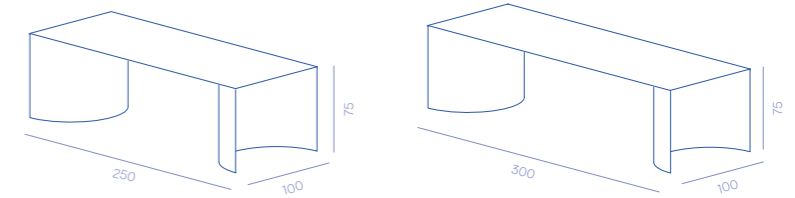

Plateaux of mirror 250
DC672 / Weight 163 kg

Plateaux of mirror 300
DC670 / Weight 180 kg

ROMA

PP. 132 | 135, 279

Metal finishes	Top in stainless steel DeOpale M0
Feet	Brushed brass M9 Brushed copper M10
Assembly	Shipped disassembled
Packaging	Wooden cage included
Details	- Sculptural table entirely made of metal

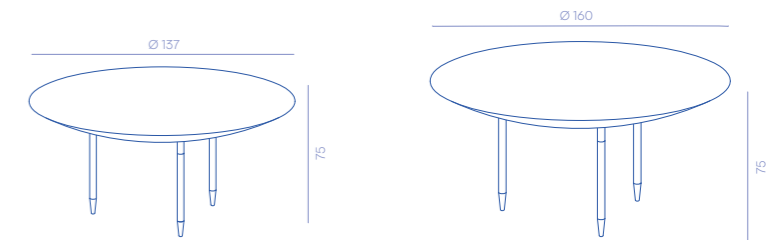

Roma 137
DC609 / Weight 100 kg

Roma 160
DC610 / Weight 130 kg

VELA

P. 136 | 139

Metal finishes	Brass Orbitale DeLabré G3
Assembly	Shipped disassembled
Packaging	Wooden cage included
Details	- Sculptural table with handmade top in Venetian- style terrace with brass inserts

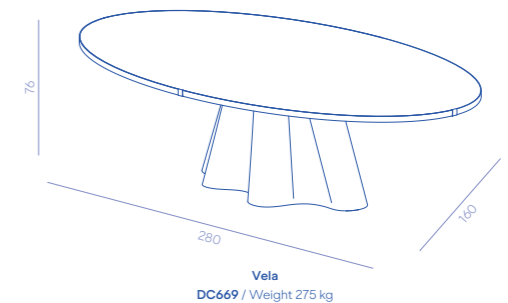

Vela
DC669 / Weight 275 kg

CARAVAN

PP. 140 | 10, 90, 324, 342

Metal finishes	Stainless steel Brushed M11 Brass Brushed M9 Copper Brushed M10
Leather	Alfa leather Acquario leather
Assembly	Shipped assembled
Packaging	Wooden cage included
Details	- Wooden monocoque and polyurethane foam seat cushions - Non-removable leather - Metal feet structure - Seat heights 45 cm

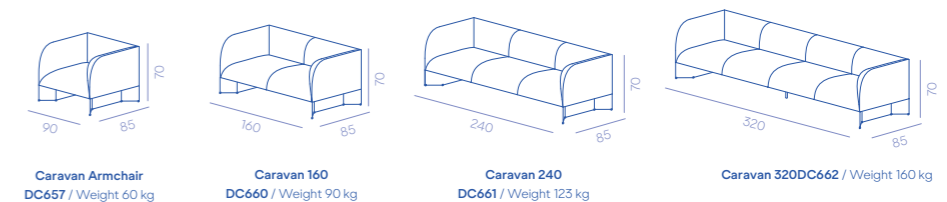

Caravan Armchair
DC657 / Weight 60 kg

Caravan 160
DC660 / Weight 90 kg

Caravan 240
DC661 / Weight 123 kg

Caravan 320 DC662 / Weight 160 kg

LOOM SOFA

PP. 142 | 187, 270

Metal finishes	Brushed M11, orbitale DeLabré G2
Stainless steel	Brushed M9, orbitale DeLabré G3
Brass	
Fabric	Fabric 1569 Asolo col. 18
Assembly	Shipped assembled
Packaging	Wooden cage included
Details	<ul style="list-style-type: none"> – Wooden monocoque and polyurethane foam seat cushions (D35 elastic density) – Removable fabric thanks to Velcro fastenings – Dry clean only – Black PVC feet – Seat heights 43 cm

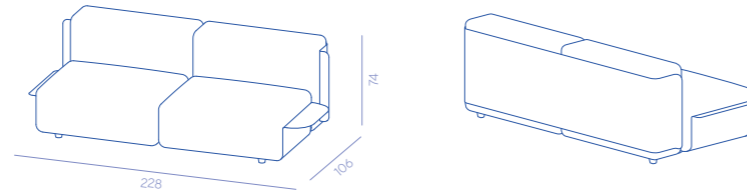

Loom Sofa
DC652 / Weight 152 kg

LOOM POUF

PP. 142 | 187, 270

Metal finishes	Brushed M11, orbitale DeLabré G2
Stainless steel	Brushed M9, orbitale DeLabré G3
Brass	
Fabric	Fabric 1569 Asolo col. 18 Composition: 39% viscose – 35% cotton – 16% polyamide – 10% linen
Assembly	Shipped assembled
Packaging	Wooden cage included
Details	<ul style="list-style-type: none"> – Wooden monocoque and polyurethane foam seat cushions (D35 elastic density) – Removable fabric thanks to Velcro fastenings – Dry clean only – Black PVC feet – Seat heights 43 cm

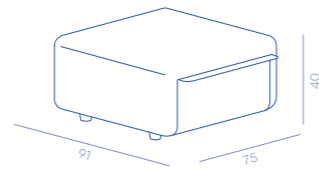

Loom Pouf
DC653 / Weight 35 kg

ORI

PP. 144 | 106

Metal finishes	Orbitale DeLabré G3
Brass	
Fabric	Tela St. Moritz L1261 – col. 126 (lilac) Composition: 80% wool 20% polyamide Tela St. Moritz L1261 – col. 130 (light blue) Composition: 80% wool 20% polyamide
Assembly	Shipped assembled
Packaging	Wooden cage included
Details	– Non-removable fabric

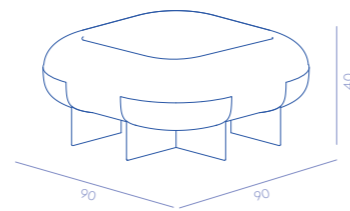

Ori
DC685 / Weight 32 kg

EFESTO

PP. 146 | 124

Metal finishes	Polished D2
Stainless steel	Polished E13
Brass	
Assembly	Shipped assembled
Packaging	Wooden cage not included, available upon request to be quoted at order confirmation
Details	– Sculptural stool entirely made of metal

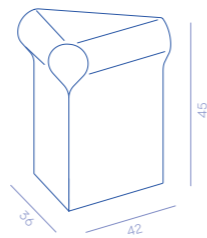

Efesto
DC684 / Weight 8 kg

PENSANDO AD ACAPULCO

PP. 148 | 150, 343

Metal finishes	Polished M14
Brass	Polished M13
Copper	
Structure	DeLabré M12
Assembly	Shipped assembled
Packaging	Wooden cage not included, available upon request to be quoted at order confirmation.
Details	<ul style="list-style-type: none"> – Armchair entirely made of metal – It consists of 3 radial pleated segments – Seat height 44 cm

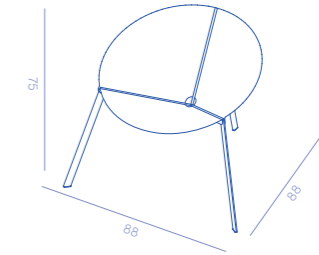

Pensando ad Acapulco
DC514 / Weight 18,4 kg

VIA VENETO

PP. 152 | 133, 279

Metal finishes	Orbitale DeLabré G2
Stainless steel	Orbitale DeLabré G3
Brass	Orbitale DeLabré G4
Copper	
Structure	DeLabré M15
Leather	Doge leather, Orione collection
Assembly	Shipped assembled
Packaging	Wooden cage not included, available upon request to be quoted at order confirmation
Details	<ul style="list-style-type: none"> – Armchair in tubular steel with upholstered seat covered in leather – Seat height 44 cm

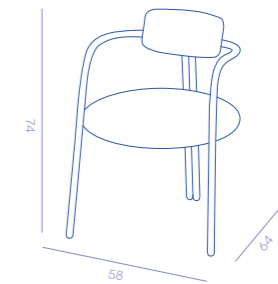

Via Veneto
DC654 / Weight 7 kg

WAVE

PP. 154 | 339

Metal finishes	Brushed M9
Brass	Brushed M10
Copper	
Assembly	Shipped assembled
Packaging	Wooden cage included
Details	<ul style="list-style-type: none"> – Bench entirely made of metal 4 mm thick – It features a movable free empty-pockets bowl and a decorative perforated pattern

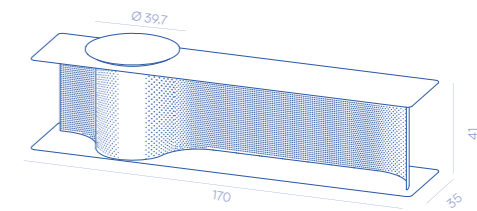

Wave
DC648 / Weight 75 kg

ALCHEMY

P. 156 | 159

Metal finishes	DeLabré E11
Stainless steel	DeLabré F2
Brass	DeLabré G5
Copper	
Base	Polished stainless steel D2
Assembly	Shipped assembled
Packaging	Wooden cage not included, available upon request to be quoted at order confirmation
Details	<ul style="list-style-type: none"> – Coffee tables entirely made of metal – The base consists on concave sides

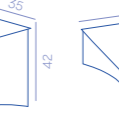
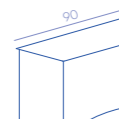
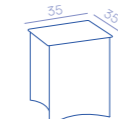
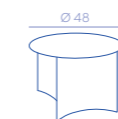
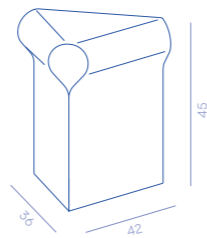

Alchemy 35
DC626
Weight 11,5 kg

Alchemy 50
DC628
Weight 12,5 kg

Alchemy Bench
DC627
Weight 22 kg

Alchemy 70
DC629
Weight 26,5 kg

Alchemy 90
DC633
Weight 38 kg

ALPHA P. 160 | 163

Metal finishes	DeErosion H12 Copper DeErosion H12
Structure	Matt lacquered RAL 7016 wood
Assembly	Shipped assembled
Packaging	Wooden cage not included, available upon request to be quoted at order confirmation
Details	- Clad in metal on all external sides, except the bottom

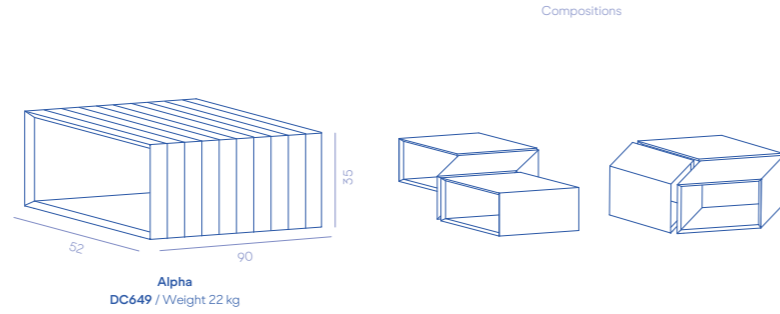

BAND PP. 164 | 97, 343

Metal finishes	DeLabré E11 Brass DeLabré F2 Copper DeLabré G5
Legs	DeLabré M12
Assembly	Shipped assembled
Packaging	Wooden cage not included, available upon request to be quoted at order confirmation
Details	- Coffee tables entirely made of metal - They feature a rods structure

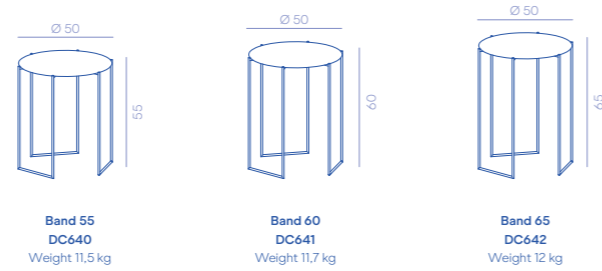

BETWEEN NATURE PP. 166 | 54

Metal finishes	DC682 Brass Brushed and polished hammered brass M9, G8	DC683 Brushed brass M9
Base	"Zebrato" eroded marble from Sisma Ipogeo "Breccia imperiale" eroded marble from Palus Ipogeo "Rosso Lepanto" eroded marble from Palus Ipogeo ^{NEW} "Breccia Capraia" eroded marble from Origo Ipogeo ^{NEW}	
Assembly	Shipped disassembled	
Packaging	Wooden cage included	
Details	- Marble by Margraf Innovation Lab	

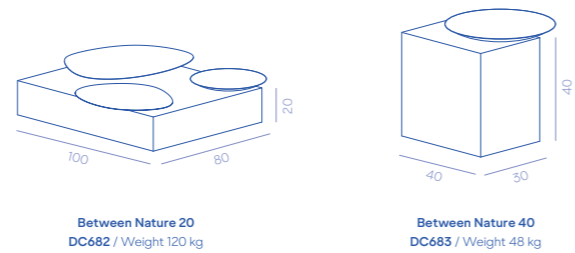

BOTERO P. 168 | 170

Metal finishes	Brushed M9
Assembly	Shipped assembled
Packaging	Wooden cage not included, available upon request to be quoted at order confirmation
Details	- Coffee tables entirely made of metal, characterized by a hole in the middle - Brass base with gradual oxidation - Top characterized by a pattern in DeErosion technique

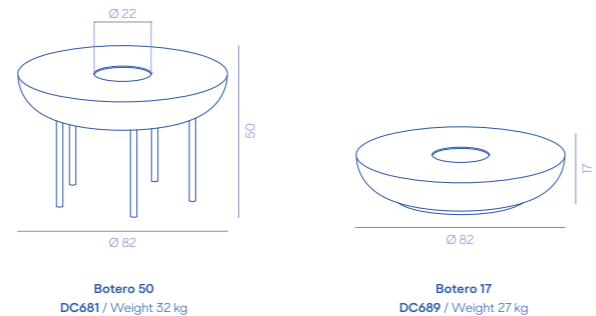

DROPS PP. 172 | 141, 218, 324

Metal finishes	DeNuance forest N1, DeNuance ocean N2, Copper matt DeNuance forest N1O, matt DeNuance ocean N2O, matt DeNuance verdigris N3O
Base	Matt black lacquered stainless steel M15 Brushed copper M10
Assembly	Shipped assembled
Packaging	Open wooden cage included
Details	- Handmade hammered top with organic shape - Legs and top finishes can be combined as desired



FLOCKS P. 176

Metal finishes	DeErosion Brass DeErosion Copper DeErosion
Base	DeLabré M12
Assembly	Shipped assembled
Packaging	Open wooden cage included
Details	- Top characterized by a pattern in DeErosion technique - Wooden lacquered undertop - Cylindrical legs in metal

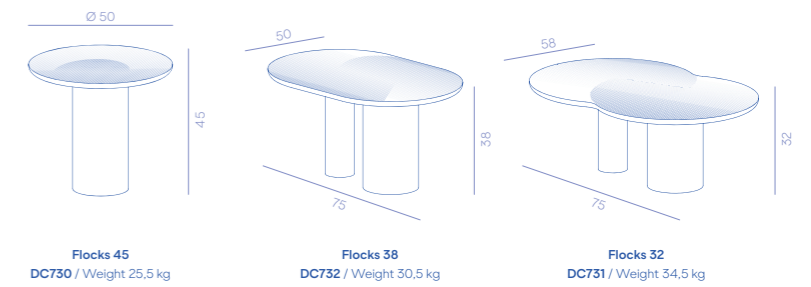

NICOLA PP. 180 | 320

Metal finishes	DeLabré E11, DeOpale M0 Stainless steel DeLabré F2, DeOpale M3 Brass DeLabré G5, DeOpale M2 Copper
Structure	DeLabré M12
Assembly	Shipped assembled
Packaging	Wooden cage not included, available upon request to be quoted at order confirmation.
Details	- Coffee tables entirely made of metal - Equipped with a ballast at the base to increase stability

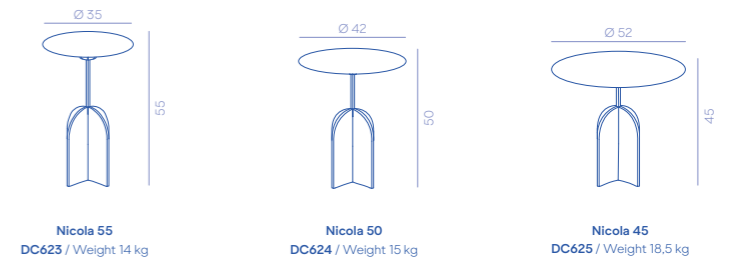

PARSEC PP. 182 | 62, 209, 278, 320

Metal finishes	DeLabré E11, DeOpale M0 Stainless steel DeLabré F2, DeOpale M3 Brass DeLabré G5, DeOpale M2 Copper
Structure	DeLabré M12
Assembly	Shipped assembled
Packaging	Open wooden cage included
Details	- Coffee tables entirely made of metal - The bowl, if ordered, is fixed and not removable - They feature a rods structure

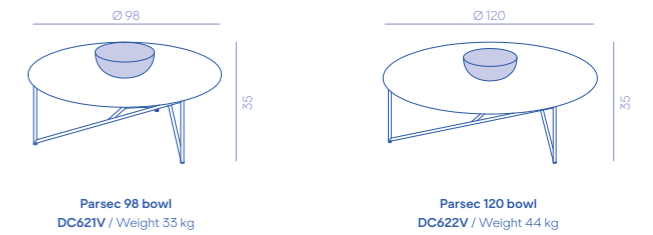

PLACAS PP. 184 | 78, 187, 235

Metal finishes	
Stainless steel	DeLabré E11, DeErosion H8
Brass	DeLabré F2, DeErosion H8
Copper	DeLabré G5, DeErosion H8
Structure	
Legs	DeLabré M12
Feet	Cast brass / cast brass with copper finishing
Assembly	
Shipped assembled	
Packaging	
Wooden cage not included, available upon request to be quoted at order confirmation	
Details	
- Coffee tables entirely made of metal - The top consists on three petal-like pieces	

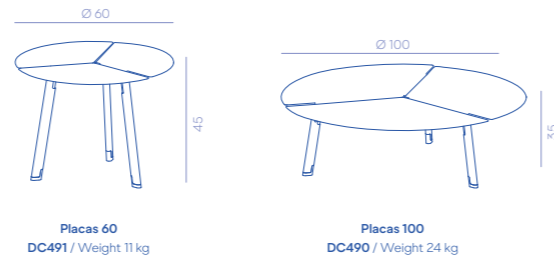

SCRIBBLE PP. 188 | 17, 191

Metal finishes	
Iron	DeLabré black iron G1
Brass	DeOpale M3, Orbitale DeLabré G3, Striped DeLabré G7
Copper	Verdigris F7, Rubin G11
Legs	
DeLabré M12	
Assembly	
Shipped assembled	
Packaging	
Wooden cage not included, available upon request to be quoted at order confirmation	
Details	
- Coffee tables entirely made of metal	

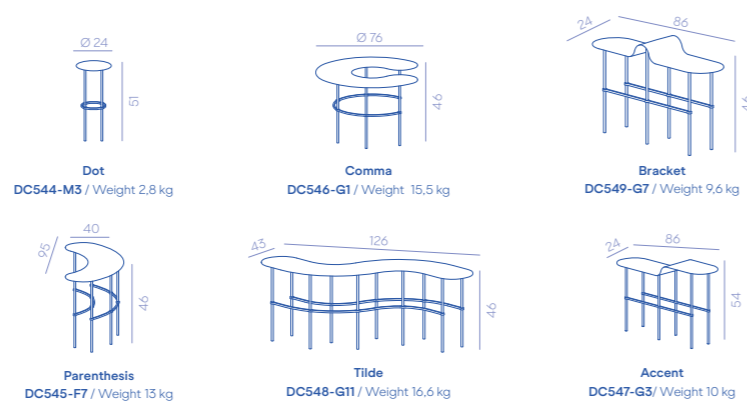

SUNRISE & SUNSET PP. 192 | 195, 223, 283

Metal finishes	
Brass	Gradual oxidation
Copper	Gradual oxidation
Base	
DeLabré M12	
Assembly	
Shipped assembled	
Packaging	
Open wooden cage included	
Details	
- Coffee tables entirely made of metal - They feature a tray-like top and a conical base supplied with ballast to ensure stability	

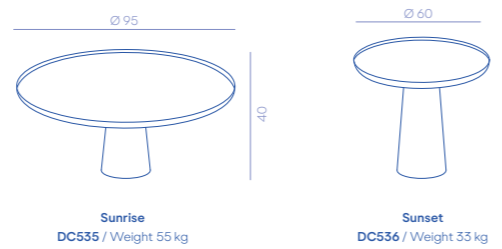

SYRO PP. 196 | 31, 87

Metal finishes	
Stainless steel	DeLabré B E5, orbitale DeLabré G2
Brass	DeLabré F2, orbitale DeLabré G3
Copper	DeLabré G5, orbitale DeLabré G4
Structure	
DeLabré M12	
Assembly	
Shipped assembled	
Packaging	
Wooden cage not included, available upon request to be quoted at order confirmation	
Details	
- Coffee tables entirely made of metal - They feature an engraved top and a rods structure	

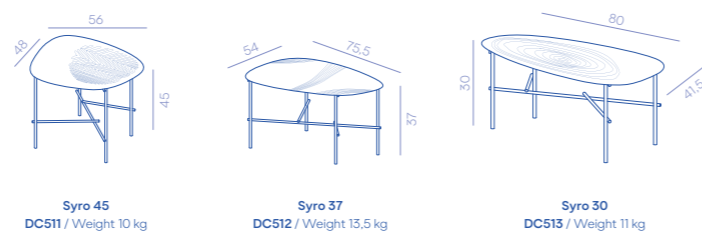

SYRO XL PP. 198 | 236

Metal finishes			
Stainless steel	DC630	DC631	DC632
Brass	-	-	DeErosion H3
Copper	DeErosion H7	DeErosion H6	DeErosion H3
Structure			
DeLabré M12			
Assembly			
Shipped assembled			
Packaging			
Wooden cage not included, available upon request to be quoted at order confirmation			
Details			
- Coffee tables entirely made of metal - They feature a top in DeErosion finishing and a rods structure			

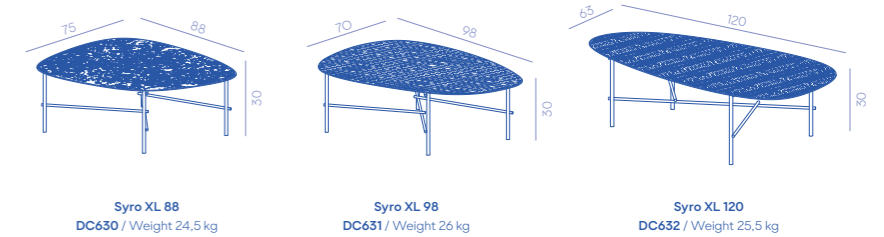

XILO COFFEE TABLE PP. 200 | 10

Metal finishes	
Brass	DeGlyphé L1, DeGlyphé L2
Assembly	
Shipped assembled	
Packaging	
Wooden cage included	
Details	
- Sculptural coffee table entirely made of 3 mm thick brass	

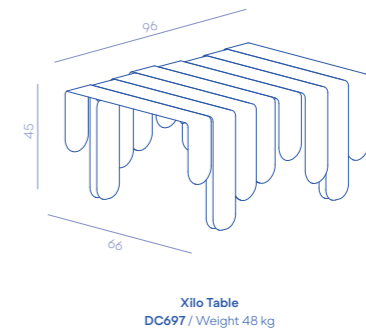

MONOLITE PP. 202 | 111

Metal finishes						
Stainless steel	DeErosion H11					
Brass	DeErosion H11					
Assembly						
Shipped assembled						
Packaging						
Wooden cage included						
Details						
- Self standing divider entirely made of metal - Integrated dimmable LED light on both sides included - Foot switch and Schuko plug						
Lighting details						
Voltage V	Freq. HZ	Power W	CLASS	IP	Temp. K°	Dimmable
230 V	50/60 HZ	42 W	I	20	3000°	YES

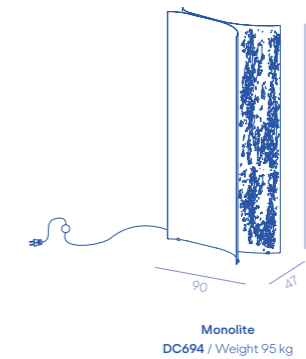

PAINTING PP. 204 | 39

Metal finishes	
Mix finishes as per photo	
Assembly	
Shipped assembled	
Packaging	
Wooden cage included	
Details	
- Self standing divider clad in metal on both sides - It features different metal finishes composing a daytime hilly scenery on one side and a nocturnal one on the other side	

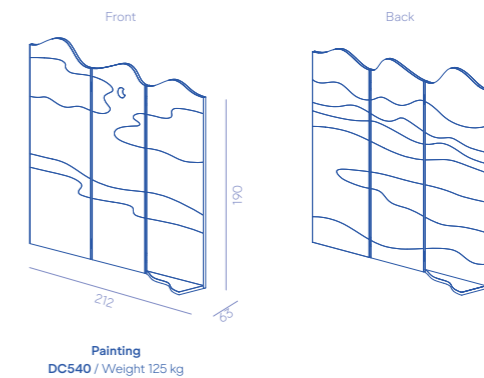

AARE WALL

PP. 206 | 62, 171

Metal finishes							
Stainless steel	DeLabré B E5, DeErosion H8						
Brass	DeLabré F2, DeErosion H8						
Copper	DeLabré G5, DeErosion H8						
Assembly							
Shipped assembled							
Packaging							
Wooden cage not included, available upon request to be quoted at order confirmation.							
Details							
- Sconce characterized by two frontal metal elements - Wall fixing system included, fixing screws excluded							
Lighting details							
Voltage V	Freq. HZ	Power W	CLASS	IP	Temp K°	Dimmable	
DC598	220-240V	50/60 HZ	5,5 W	I	20	3000°	YES - DALI
DC599	220-240V	50/60 HZ	14,2 W	I	20	3000°	YES - DALI
DC600	220-240V	50/60 HZ	21 W	I	20	3000°	YES - DALI

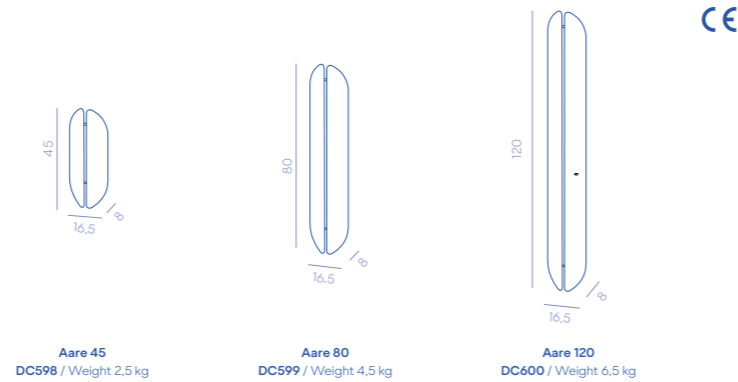

AARE CEILING

PP. 206 | 55

Metal finishes							
Stainless steel	DeLabré B E5, DeErosion H8						
Brass	DeLabré F2, DeErosion H8						
Copper	DeLabré G5, DeErosion H8						
Assembly							
Shipped assembled							
Packaging							
Wooden cage not included, available upon request to be quoted at order confirmation							
Details							
- Suspended lamp characterized by two metal elements - Supplied with a 3 m power cable and a 3 m steel fixing cable - Adjustable suspension cables - Ceiling fixing system included, fixing screws excluded							
Lighting details							
Voltage V	Freq. HZ	Power W	CLASS	IP	Temp K°	Dimmable	
DC720	100-240V	50/60 HZ	55 W	I	20	3000°	YES - DALI
DC721	100-240V	50/60 HZ	90 W	I	20	3000°	YES - DALI

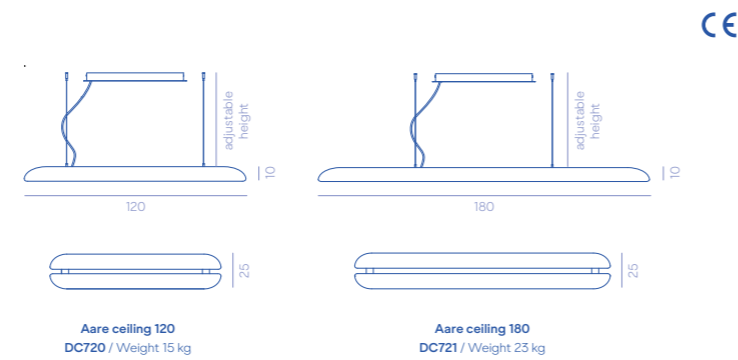

FOLIAGE

PP. 212 | 125

Metal finishes							
Stainless steel	DeLabré E11						
Brass	DeLabré F2						
Copper	DeLabré G5						
Assembly							
Shipped disassembled							
Packaging							
Wooden cage not included, available upon request to be quoted at order confirmation							
Details							
- 3 independent pendant modules with incorporated transformer each in the ceiling rosette - Adjustable suspension cables - Standard overall height 180 cm - Only for indoor use							
Lighting details							
Voltage V	Freq. HZ	Power W	CLASS	IP	Temp K°	Dimmable	
DC710	120-240V	50/60 HZ	16 W	I	44	3000°	YES - DALI
DC711	120-240V	50/60 HZ	16 W	I	44	3000°	YES - DALI
DC712	120-240V	50/60 HZ	26 W	I	44	3000°	YES - DALI

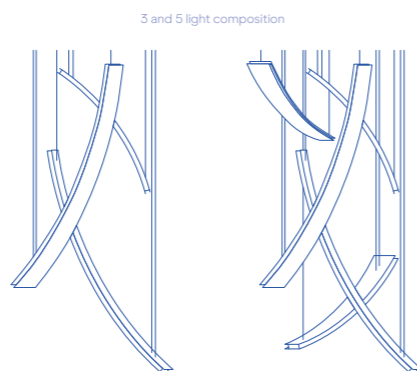
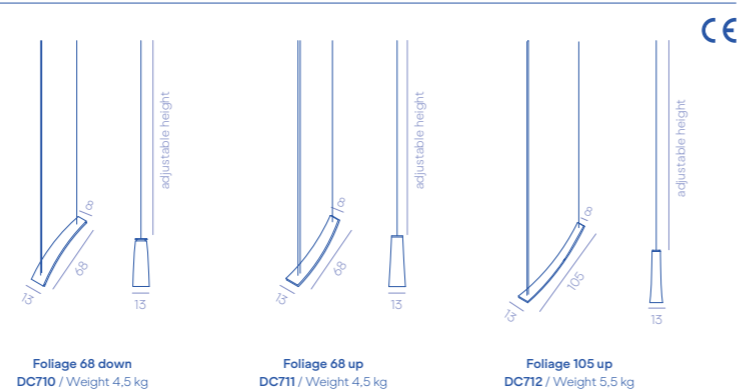

LIGHT&SHADE

PP. 214 | 54, 219

Metal finishes						
Stainless steel	DeDeep G12, DeMarea M4					
Brass	DeSalt M7, DeMarea M6					
Copper	DeLabré G5, DeMarea M5					
Assembly						
Shipped disassembled						
Packaging						
Wooden cage not included, available upon request to be quoted at order confirmation						
Details						
- Applique lighting with incorporated transformer - Integrated fixing system - Three different fixing positions						
Lighting details						
Voltage V	Freq. HZ	Power W	CLASS	IP	Temp K°	Dimmable
120-240V	50/60 HZ	28,8 W	I	44	3000°	YES - DALI

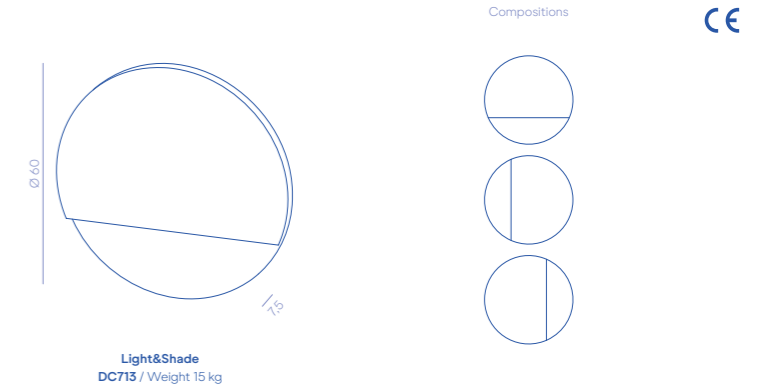

LUCE SOLIDA

PP. 220 | 75, 159, 223, 271, 278, 279

Metal finishes							
Iron	DeLabré B E5						
Brass	DeLabré F2						
Assembly							
Shipped assembled							
Packaging							
Wooden cage not included, available upon request to be quoted at order confirmation							
Details							
- Hanging lamp with a diffuser made of thin metal rods - Supplied with a 3 m power cable and a 3 m steel fixing cable - Bracket and cable cap included, screws excluded							
Lighting details							
Voltage V	Freq. HZ	Power W	CLASS	IP	Temp K°	Dimmable	
DC469	230 V	50/60 HZ	MAX 6 W	I	20	2700°	NO
DC470	230 V	50/60 HZ	MAX 6 W	I	20	2700°	NO
DC471	230 V	50/60 HZ	MAX 6 W	I	20	2700°	NO

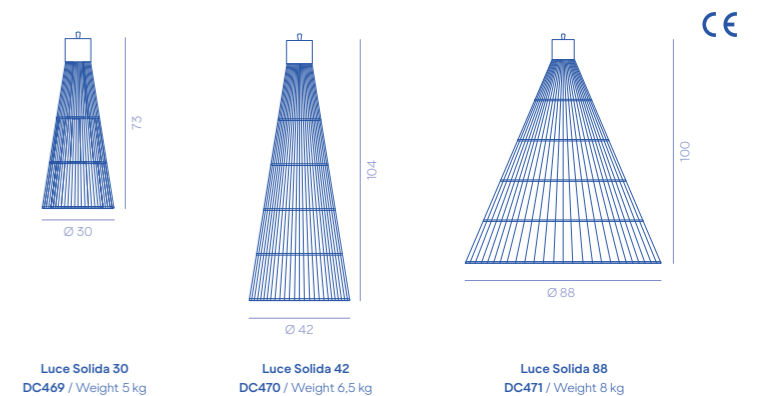

RIBOT

P. 224

Metal finishes						
Brass	Polished hammered G8					
Assembly						
Shipped assembled						
Packaging						
Open wooden cage included						
Details						
Floor lamp with foot switch and European socket						
Lighting details						
Voltage V	Freq. HZ	Power W	CLASS	IP	Temp K°	Dimmable
230 V	50/60 HZ	11 W	II	20	3000°	NO

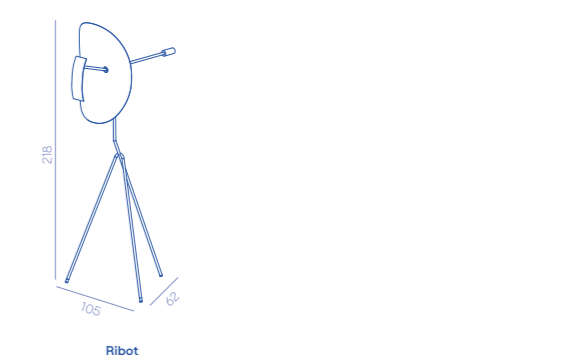

TWIST TABLE

P. 226 | 228

Metal finishes						
Brass	Orbitale DeLabré G3					
Copper	Orbitale DeLabré G4					
Assembly						
Shipped assembled						
Packaging						
Wooden cage not included, available upon request to be quoted at order confirmation						
Details						
- Highly artisan made product, dimensional differences could occur - Table lamp entirely made of metal - Cable with dimmer						
Lighting details						
Voltage V	Freq. HZ	Power W	CLASS	IP	Temp K°	Dimmable
220-240 V	50/60 HZ	24 W	I	20	3000°	YES - DALI

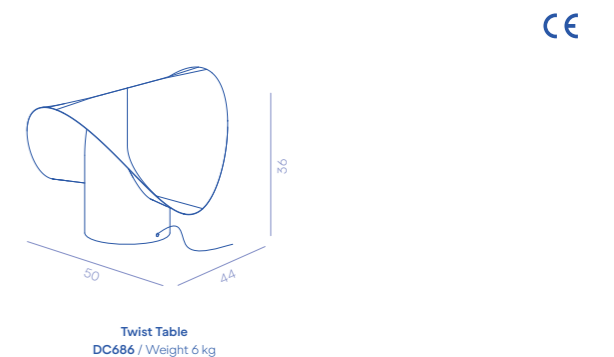

TWIST CEILING

PP. 226 | 139

Metal finishes	Orbitale DeLabré G3 Orbitale DeLabré G4														
Assembly	Shipped assembled														
Packaging	Wooden cage not included, available upon request to be quoted at order confirmation.														
Details	<ul style="list-style-type: none"> - Highly artisan made product, dimensional differences could occur - Suspended lamp with transformer incorporated in the ceiling rosette - Ceiling fixing system included, fixing screws excluded - Adjustable fixing ropes 														
Lighting details	<table border="1"> <tr> <th>Voltage V</th> <th>Freq. HZ</th> <th>Power W</th> <th>CLASS</th> <th>IP</th> <th>Temp.K°</th> <th>Dimmable</th> </tr> <tr> <td>220-240 V</td> <td>50/60 HZ</td> <td>15 W</td> <td>I</td> <td>20</td> <td>2700°</td> <td>YES - DALI</td> </tr> </table>	Voltage V	Freq. HZ	Power W	CLASS	IP	Temp.K°	Dimmable	220-240 V	50/60 HZ	15 W	I	20	2700°	YES - DALI
Voltage V	Freq. HZ	Power W	CLASS	IP	Temp.K°	Dimmable									
220-240 V	50/60 HZ	15 W	I	20	2700°	YES - DALI									

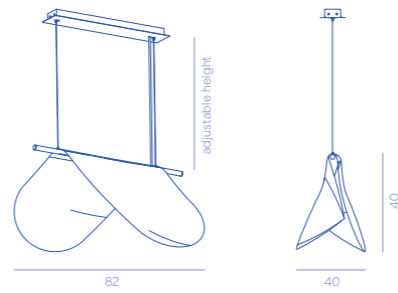

Twist ceiling
DC687 / Weight 8 kg



BRAME

PP. 230 | 58

Metal finishes	DeDeep G12 Orbitale DeLabré G3														
Assembly	Shipped assembled.														
Packaging	Wooden cage included														
Details	<ul style="list-style-type: none"> - Wall mirror with a huge concave frame entirely made of metal - LED backlit mirror option available - Wall fixing system included, fixing screws excluded 														
Lighting details	<table border="1"> <tr> <th>Voltage V</th> <th>Freq. HZ</th> <th>Power W</th> <th>CLASS</th> <th>IP</th> <th>Temp.K°</th> <th>Dimmable</th> </tr> <tr> <td>230 V</td> <td>50/60 HZ</td> <td>37 W</td> <td>I</td> <td>20</td> <td>2700°</td> <td>NO</td> </tr> </table>	Voltage V	Freq. HZ	Power W	CLASS	IP	Temp.K°	Dimmable	230 V	50/60 HZ	37 W	I	20	2700°	NO
Voltage V	Freq. HZ	Power W	CLASS	IP	Temp.K°	Dimmable									
230 V	50/60 HZ	37 W	I	20	2700°	NO									

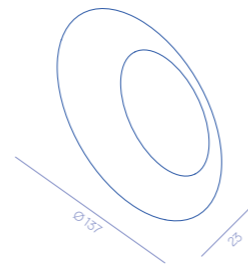

Brame
DC671 / Weight 50 kg



FRAME

PP. 232 | 234

Metal finishes	Orbitale DeLabré G2 Orbitale DeLabré G3 Orbitale DeLabré G4
Assembly	Shipped assembled.
Packaging	Wooden cage included
Details	<ul style="list-style-type: none"> - Wall fixing system included, fixing screws excluded - Parallel and inclined wall fixing system - Parallel wall fixing system only

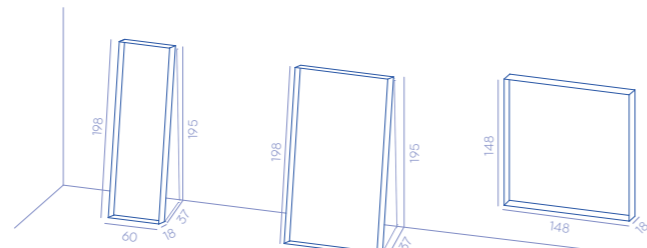

Frame 60
DC480 / Weight 52 kg

Frame 110
DC482 / Weight 92 kg

Frame 148
DC481 / Weight 100 kg

RIFLESSO

PP. 236 | 38, 74, 107, 135

Metal finishes	Orbitale DeLabré G2 Orbitale DeLabré G3
Assembly	Shipped assembled.
Packaging	Wooden cage not included, available upon request to be quoted at order confirmation.
Details	- Wall fixing system included, fixing screws excluded

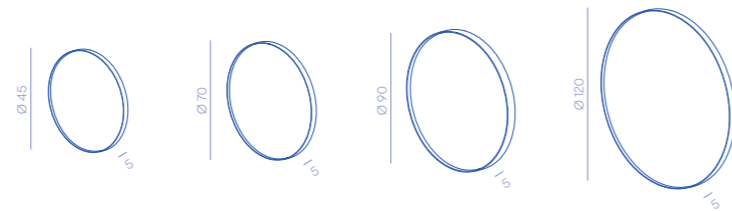

Riflesso 45
DC608-450
Weight 6,6 kg

Riflesso 70
DC608-700
Weight 13,5 kg

Riflesso 90
DC608-900
Weight 20 kg

Riflesso 120
DC608-1200
Weight 27 kg

SYRO MIRROR

PP. 238 | 27, 342

Metal finishes	Orbitale DeLabré G2 Orbitale DeLabré G3
Assembly	Shipped assembled. Screws excluded.
Packaging	Wooden cage not included, available upon request to be quoted at order confirmation.
Details	<ul style="list-style-type: none"> - Horizontal and vertical fixing option - Wall fixing system included, fixing screws excluded

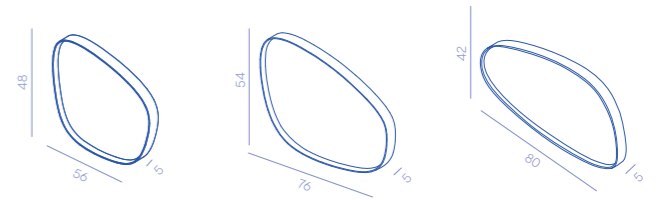

Syro Mirror 56
DC620 / Weight 9 kg

Syro Mirror 76
DC619 / Weight 12 kg

Syro Mirror 80
DC618 / Weight 10,5 kg

A-MODULO

P. 250

Metal finishes	Bronzed DeMastral D3, RAL 9010 lacquered D8, satin D1, noir sablé E8, marron sablé E9
Assembly	Shipped disassembled
Packaging	Wooden cage not included, available upon request to be quoted at order confirmation
Details	<ul style="list-style-type: none"> - Modular flower pot composed by different on-line sections - Drainage composites included - Fixing cross to be added starting from two subsequent modules

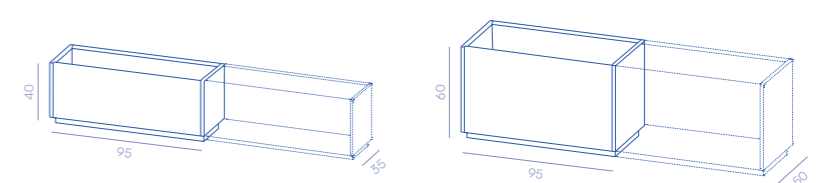

A-Modulo 40

A-Modulo 60

COHIBA LARGE

P. 251

Metal finishes	Natural D6, Waxed D7 Orbitale DeLabré G2, bronzed DeMastral D3, RAL 9010 lacquered D8, satin D1
Assembly	Shipped assembled
Packaging	Wooden cage not included, available upon request to be quoted at order confirmation.
Details	<ul style="list-style-type: none"> - Inner plastic pot included - Equipped with close base for an indoor use, perforated base for outdoor - The indoor or outdoor use has to be specified at order confirmation - Fixing floor plate available upon request

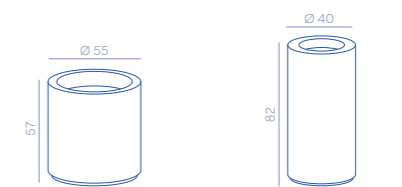

Cohiba large 57
DC410 / Weight 18 kg

Cohiba large 82
DC411 / Weight 16 kg

COHIBA SLIM

P. 251

Metal finishes	Natural D6, Waxed D7 Orbitale DeLabré G2, bronzed DeMastral D3, RAL 9010 lacquered D8, satin D1, polished D2
Assembly	Shipped assembled
Packaging	Wooden cage not included, available upon request to be quoted at order confirmation.
Details	<ul style="list-style-type: none"> - Inner plastic pot included - Equipped with close base for an indoor use, perforated base for outdoor - The indoor or outdoor use has to be specified at order confirmation - Fixing floor plate available upon request

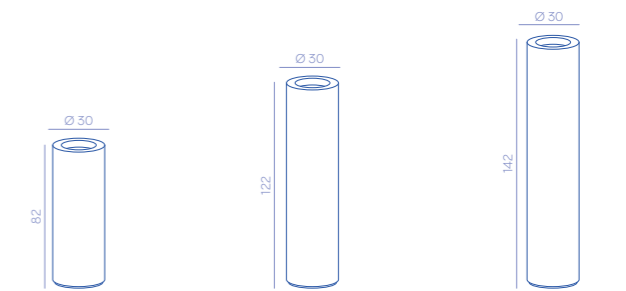

Cohiba slim 82
DC412 / Weight 11 kg

Cohiba slim 122
DC413 / Weight 11,5 kg

Cohiba slim 142
DC414 / Weight 12 kg

CONIQUE

P. 252

Metal finishes	Corten Natural D6, Waxed D7 Stainless steel Orbitale DeLabré G2, bronzed DeMastral D3, RAL 9010 lacquered D8, satin D1
Assembly	Shipped assembled
Packaging	Wooden cage not included, available upon request to be quoted at order confirmation.
Details	<ul style="list-style-type: none"> - Inner plastic pot included - Equipped with close base for an indoor use, perforated base for outdoor - The indoor or outdoor use has to be specified at order confirmation - Fixing floor plate available upon request

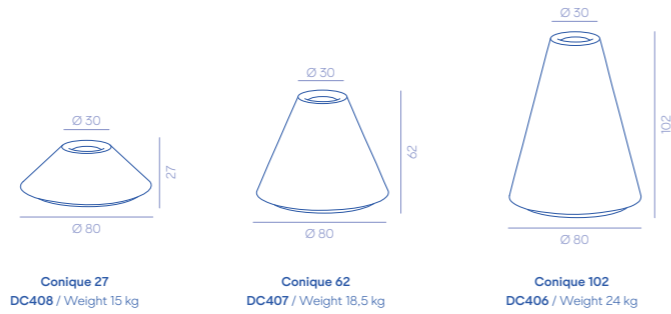

Conique 27
DC408 / Weight 15 kg

Conique 62
DC407 / Weight 18,5 kg

Conique 102
DC406 / Weight 24 kg

CUBE

P. 253

Metal finishes	Corten Natural D6, Waxed D7 Stainless steel Orbitale DeLabré G2, bronzed DeMastral D3, RAL 9010 lacquered D8, satin D1
Assembly	Shipped assembled
Packaging	Wooden cage not included, available upon request to be quoted at order confirmation
Details	<ul style="list-style-type: none"> - Inner plastic pot included for an indoor use, drainage composites included for outdoor - Equipped with close base for an indoor use, perforated base for outdoor - The indoor or outdoor use has to be specified at order confirmation - Fixing floor plate available upon request

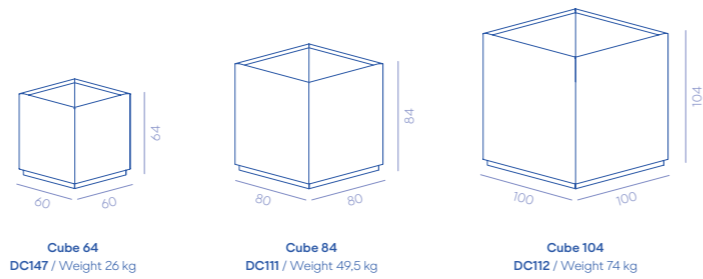

Cube 64
DC147 / Weight 26 kg

Cube 84
DC111 / Weight 49,5 kg

Cube 104
DC112 / Weight 74 kg

DAFNE & DEMETRA

P. 254

Metal finishes	Stainless steel DeLabré B E5, bronzed DeMastral D3, RAL 9010 lacquered D8
Assembly	Shipped assembled
Packaging	Wooden cage not included, available upon request to be quoted at order confirmation.
Details	<ul style="list-style-type: none"> - Concret ballast and lighting kit available upon request - Equipped with close base for an indoor use, perforated base for outdoor - The indoor or outdoor use has to be specified at order confirmation - LED kit available upon request

Lighting details	Voltage V	Freq. HZ	Power W	CLASS	IP	Temp K°	Dimmable
DC000-0025	230V	50/60 HZ	15 W	II	64 PLUG 65 BODY	3000°	NO

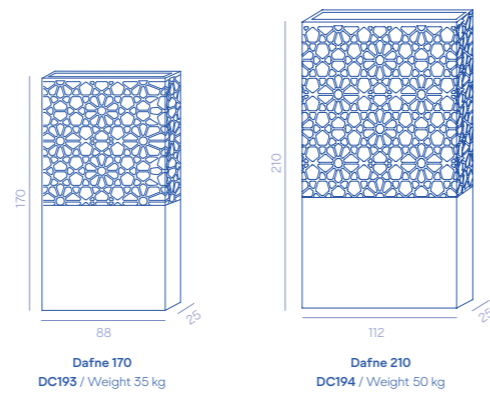

Dafne 170
DC193 / Weight 35 kg

Dafne 210
DC194 / Weight 50 kg

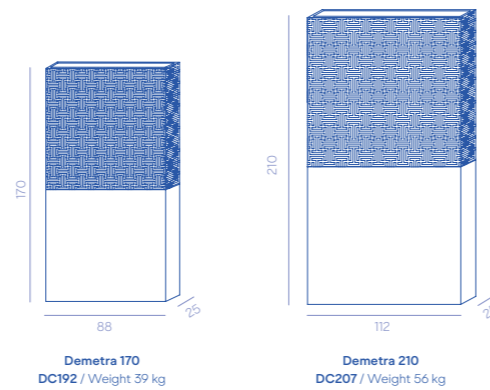

Demetra 170
DC192 / Weight 39 kg

Demetra 210
DC207 / Weight 56 kg

DELTA

P. 256

Metal finishes	Corten Natural D6, Waxed D7 Stainless steel Bronzed DeMastral D3, RAL 9010 lacquered D8, satin D1
Assembly	Shipped assembled
Packaging	Wooden cage not included, available upon request to be quoted at order confirmation.
Details	<ul style="list-style-type: none"> - Inner plastic pot included - Fixing floor plate available upon request - Equipped with close base for an indoor use, perforated base for outdoor - The indoor or outdoor use has to be specified at order confirmation

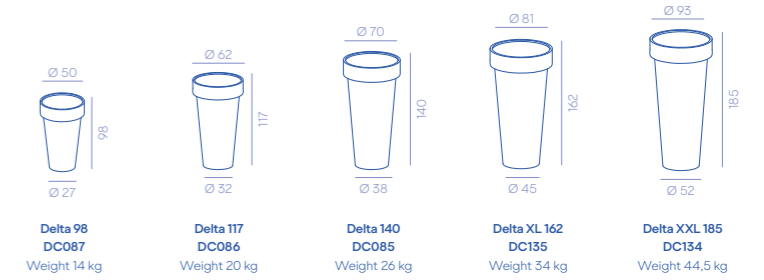

Delta 98
DC087
Weight 14 kg

Delta 117
DC086
Weight 20 kg

Delta 140
DC085
Weight 26 kg

Delta XL 162
DC135
Weight 34 kg

Delta XXL 185
DC134
Weight 44,5 kg

OMEGA

P. 256

Metal finishes	Corten Natural D6, Waxed D7 Stainless steel Bronzed DeMastral D3, RAL 9010 lacquered D8, satin D1
Assembly	Shipped assembled
Packaging	Wooden cage not included, available upon request to be quoted at order confirmation
Details	<ul style="list-style-type: none"> - Inner plastic pot included - Fixing floor plate available upon request - Equipped with close base for an indoor use, perforated base for outdoor - The indoor or outdoor use has to be specified at order confirmation

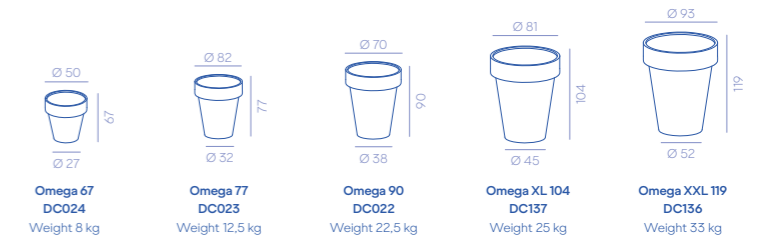

Omega 67
DC024
Weight 8 kg

Omega 77
DC025
Weight 12,5 kg

Omega 90
DC022
Weight 22,5 kg

Omega XL 104
DC157
Weight 25 kg

Omega XXL 119
DC136
Weight 33 kg

NARNYA

P. 257

Metal finishes	Corten Natural D6, Waxed D7 Stainless steel Orbitale DeLabré G2, bronzed DeMastral D3, RAL 9010 lacquered D8, satin D1, polished D2
Assembly	Shipped assembled
Packaging	Wooden cage not included, available upon request to be quoted at order confirmation
Details	<ul style="list-style-type: none"> - Inner plastic pot included - Fixing floor plate available upon request - Equipped with close base for an indoor use, perforated base for outdoor - The indoor or outdoor use has to be specified at order confirmation

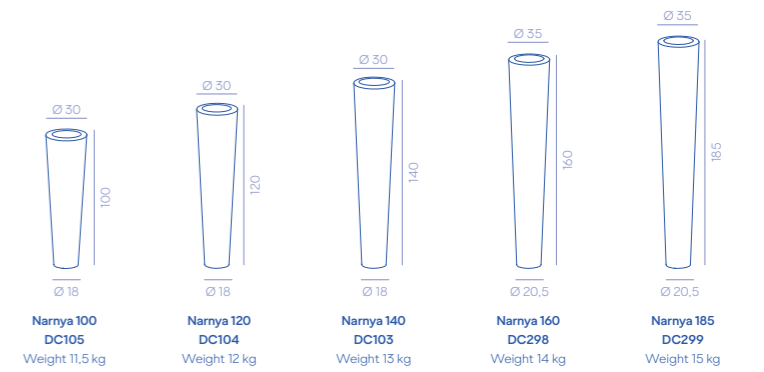

Narnya 100
DC105
Weight 11,5 kg

Narnya 120
DC104
Weight 12 kg

Narnya 140
DC103
Weight 13 kg

Narnya 160
DC298
Weight 14 kg

Narnya 185
DC299
Weight 15 kg

PHIL

P. 258

Metal finishes	Stainless steel DeLabré B E5 and polished D2 as per photo
Assembly	Shipped assembled
Packaging	Wooden cage not included, available upon request to be quoted at order confirmation
Details	<ul style="list-style-type: none"> - Inner plastic pot included - Fixing floor plate available upon request - Equipped with close base for an indoor use, perforated base for outdoor - The indoor or outdoor use has to be specified at order confirmation

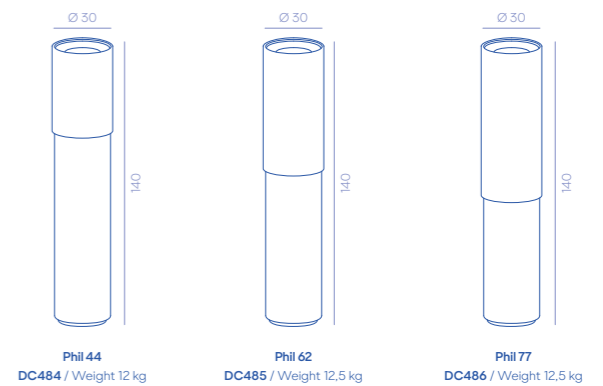

Phil 44
DC484 / Weight 12 kg

Phil 62
DC485 / Weight 12,5 kg

Phil 77
DC486 / Weight 12,5 kg

RIVIERA POTS

P. 259

Metal finishes	Stainless steel Bronzed DeMastral D3, RAL 9010 lacquered D8
Assembly	Shipped assembled
Packaging	Wooden cage not included, available upon request to be quoted at order confirmation
Details	<ul style="list-style-type: none"> - Inner plastic pot included - Equipped with close base for an indoor use, perforated base for outdoor - The indoor or outdoor use has to be specified at order confirmation

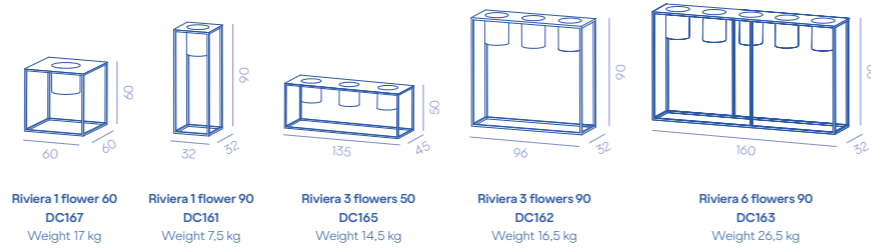

ROCCO & LOLITA

P. 260

Metal finishes	Stainless steel Brass	Bronzed DeMastral D3, orbitale DeLabré G2 Orbitale DeLabré G3
Assembly	Shipped assembled	
Packaging	Wooden cage not included, available upon request to be quoted at order confirmation	
Details	<ul style="list-style-type: none"> - Decorative pot - The indoor or outdoor use has to be specified at order confirmation - Fixing floor plate available upon request 	

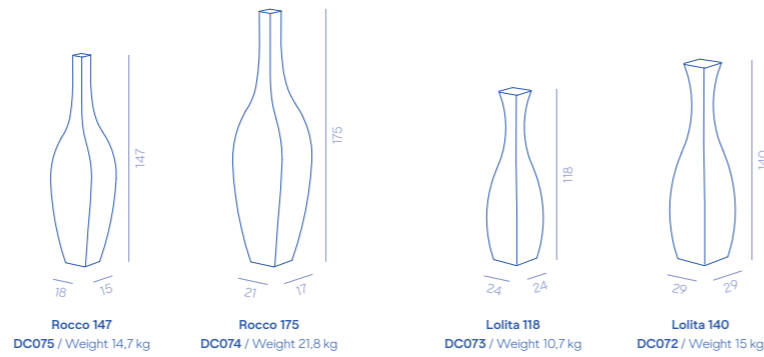

SCREEN-POT

P. 261

Metal finishes	Corten Stainless steel Brass	Natural D6, Waxed D7 Bronzed DeMastral D3, RAL 9010 lacquered D8 Orbitale DeLabré G3
Assembly	Shipped assembled	
Packaging	Wooden cage not included, available upon request to be quoted at order confirmation	
Details	<ul style="list-style-type: none"> - Inner plastic pot included for an indoor use, drainage composites included for outdoor - Equipped with close base for an indoor use, perforated base for outdoor - The indoor or outdoor use has to be specified at order confirmation 	

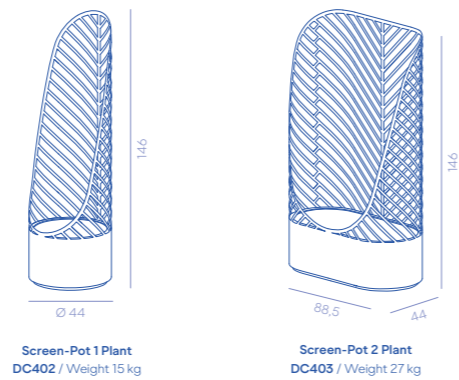

SHIMLA & JAIPUR

P. 262

Metal finishes	Stainless steel Brass	Bronzed DeMastral D3, orbitale DeLabré G2 Orbitale DeLabré G3
Assembly	Shipped assembled	
Packaging	Wooden cage not included, available upon request to be quoted at order confirmation	
Details	<ul style="list-style-type: none"> - Decorative pot - Fixing floor plate available upon request - The indoor or outdoor use has to be specified at order confirmation 	

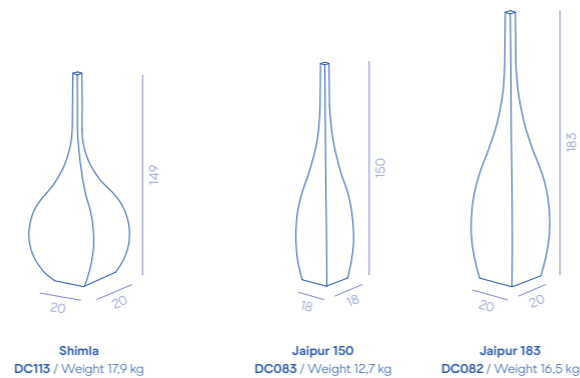

TRISTAN & ISOTTE

P. 263

Metal finishes	Stainless steel	DeMastral brunito D3
Assembly	Shipped assembled	
Packaging	Wooden cage not included, available upon request to be quoted at order confirmation	
Details	<ul style="list-style-type: none"> - Decorative pot - Equipped with closed top for outdoor use - The indoor or outdoor use has to be specified at order confirmation - Fixing floor plate available upon request 	

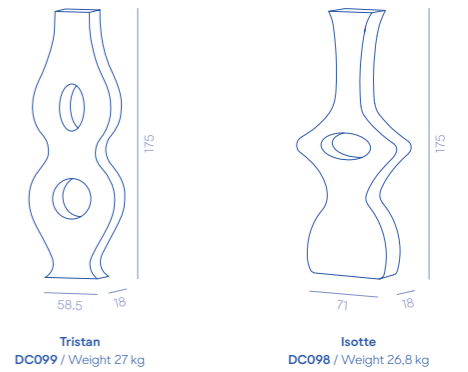

COTTAGE N.1

P. 264

Metal finishes	Corten	Natural D6
Wall, floor and shelves	Bleached fir wood treated for outdoor	
Assembly	Shipped disassembled	
Packaging	Wooden cage included	
Details	<ul style="list-style-type: none"> - Hut/garden shed equipped with internal shelves - Door with key and lock - Earthing and electrical system available upon request 	

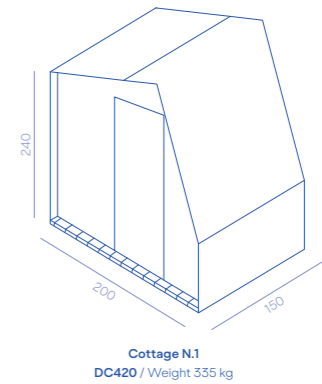

DOG HOUSE N.1

P. 265

Metal finishes	Corten	Natural D6
Wall, floor and shelves	Bleached fir wood treated for outdoor	
Assembly	Shipped assembled	
Packaging	Wooden cage not included, available upon request to be quoted at order confirmation	
Details	- Outdoor dog house in wood clad in corten	

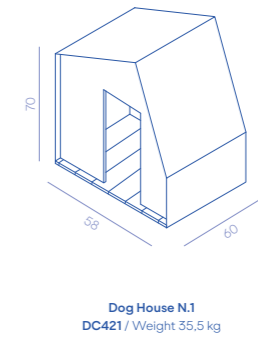

NEST HOUSE N.1

P. 265

Metal finishes	Corten	Natural D6
Wall, floor and shelves	Bleached fir wood treated for outdoor	
Assembly	Shipped assembled	
Packaging	Wooden cage not included, available upon request to be quoted at order confirmation	
Details	- Outdoor birdhouse in wood clad in corten	

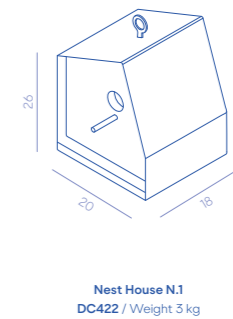

CIPHER

P. 268 | 270, 271

Metal finishes	DeErosion Brass Copper
Installation	- At least 2 mm grout line is required - It can be installed using epoxy adhesives and grouts - It can be processed on site with suitable tools, refer to Installation Manual for procedures and details
Cladding	Wall only
Usage	- Indoor only - Shower cabin and areas in direct contact with water excluded - Bathroom and kitchen backsplash are not recommended
Details	- Elements not sold individually, only in KIT - Minimum order 20 KIT - 24 KIT are required to clad 1 m ²

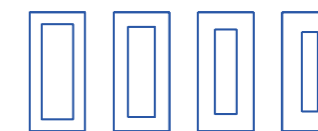

Cipher (4 modules)
DS108-KIT

- Dimensions
7 x 14 cm
- Thickness
2 mm
- Weight
17-17,8 kg/m²

Laying

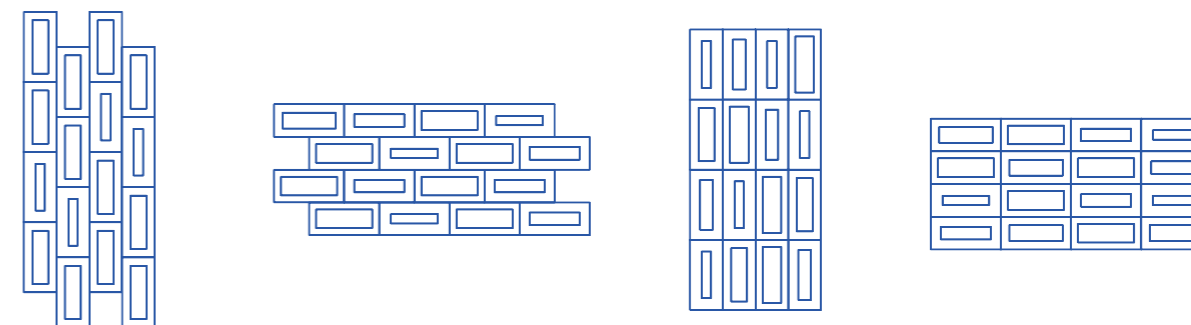

DEEROSION

PP. 272 | 163, 274

Metal finishes	DeErosion H8 Stainless steel Brass Copper
Installation	- At least 2 mm grout line is required - It can be installed using epoxy adhesives and grouts - It can be processed on site with suitable tools, refer to Installation Manual for procedures and details
Cladding	Wall only
Usage	- Indoor only - Shower cabin and areas in direct contact with water excluded - Bathroom and kitchen backsplash are not recommended
Details	- H4, H6 and H7 patterns are MINI, reduced in scale than the standard ones - Minimum order 12 tiles - 12 tiles are required to clad 1 m ²

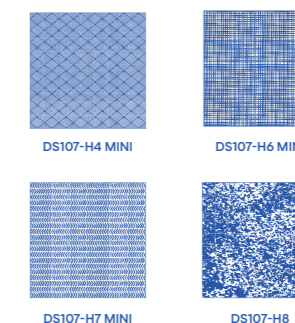

- Dimensions
30 x 30 cm
- Thickness
2 mm
- Weight
16-17,8 kg/m²

Laying

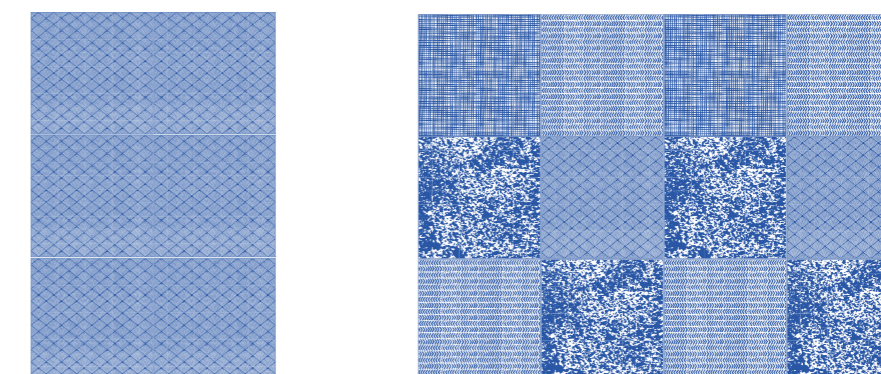

FORMA P. 276

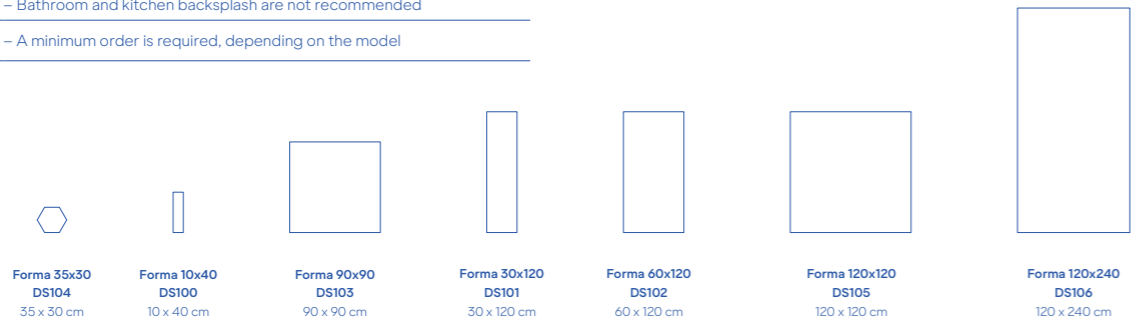

Metal finishes	DS100, DS101, DS102, DS103, DS104 DeDeep G12, DeLabré B E5, Orbitale DeLabré G2, Striped DeLabré E6 DeLabré F2, Striped DeLabré G7, Orbitale DeLabré G3, Brushed M9 DeLabré G5, Striped DeLabré G6, Orbitale DeLabré G4, Brushed M10	DS105, DS106 DeDeep G12, DeLabré B E5, Orbitale DeLabré G2, Striped DeLabré E6 DeLabré F2, Striped DeLabré G7, Orbitale DeLabré G3, Brushed M9	 Dimensions 7 sizes available  Thickness 2 mm  Weight 16-17,8 kg/m ²
Installation	- At least 2 mm grout line is required - It can be installed using epoxy adhesives and grouts - It can be processed on site with suitable tools, refer to Installation Manual for procedures and details		
Cladding	Wall only		
Usage	- Indoor only - Shower cabin and areas in direct contact with water excluded - Bathroom and kitchen backsplash are not recommended		
Details	- A minimum order is required, depending on the model		

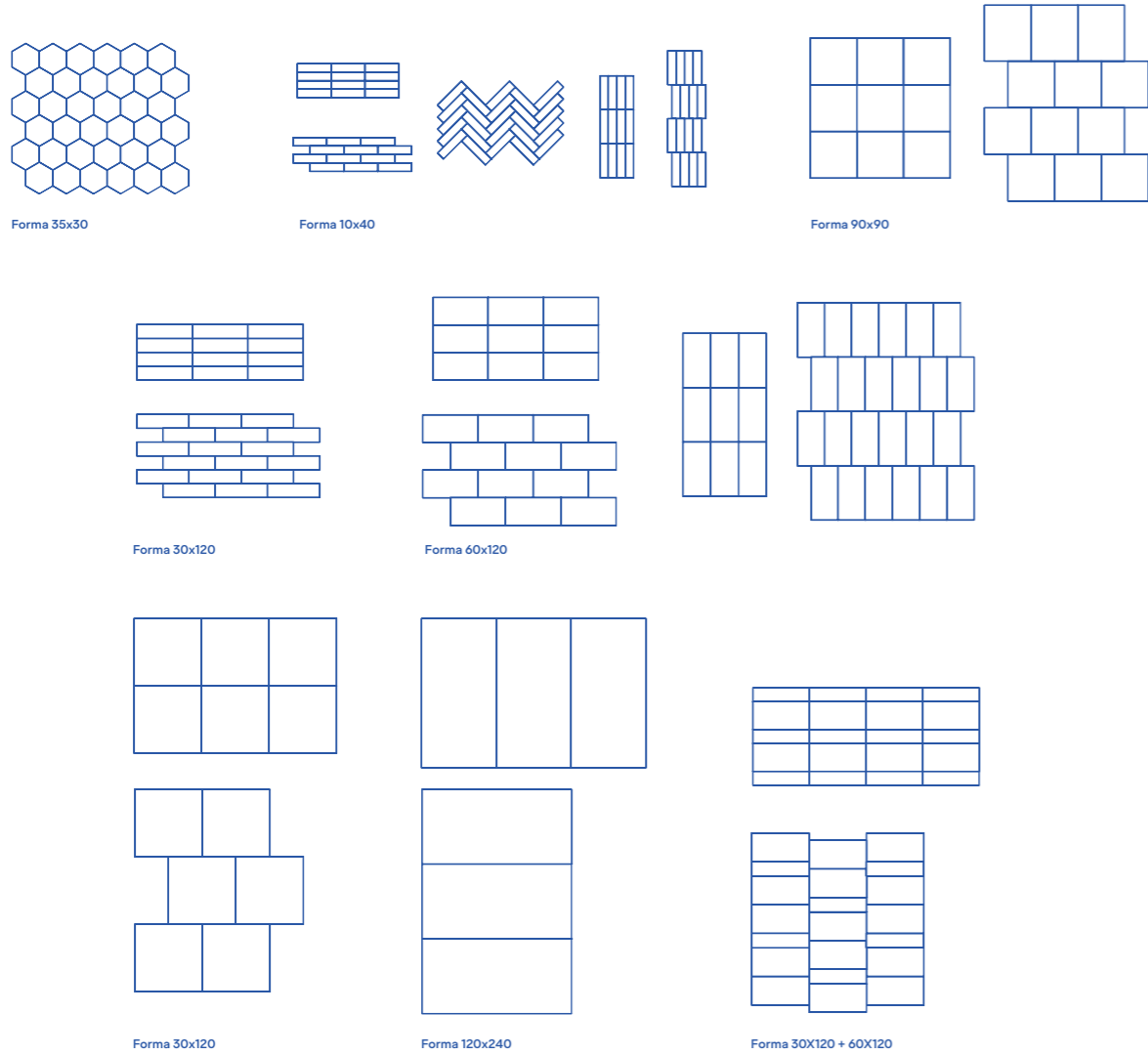

Laying



YOKO P. 284



Metal finishes	DeDeep G12 Brushed M9 Copper insert	DeDeep G12 Brushed M9 Brushed M10	 Dimensions 30 x 30 cm  Thickness 4 mm  Weight 24-25,2 kg/m ²
Installation	- At least 2 mm grout line is required - It can be installed using epoxy adhesives and grouts - It can be processed on site with suitable tools, refer to Installation Manual for procedures and details		
Cladding	Wall only		
Usage	- Indoor only - Shower cabin and areas in direct contact with water excluded - Bathroom and kitchen backsplash are not recommended		
Details	- Minimum order 12 tiles - 12 tiles are required to clad 1 m ² - Elements not sold individually, only in KIT - Minimum order 20 KIT - 24 KIT are required to clad 1 m ²		

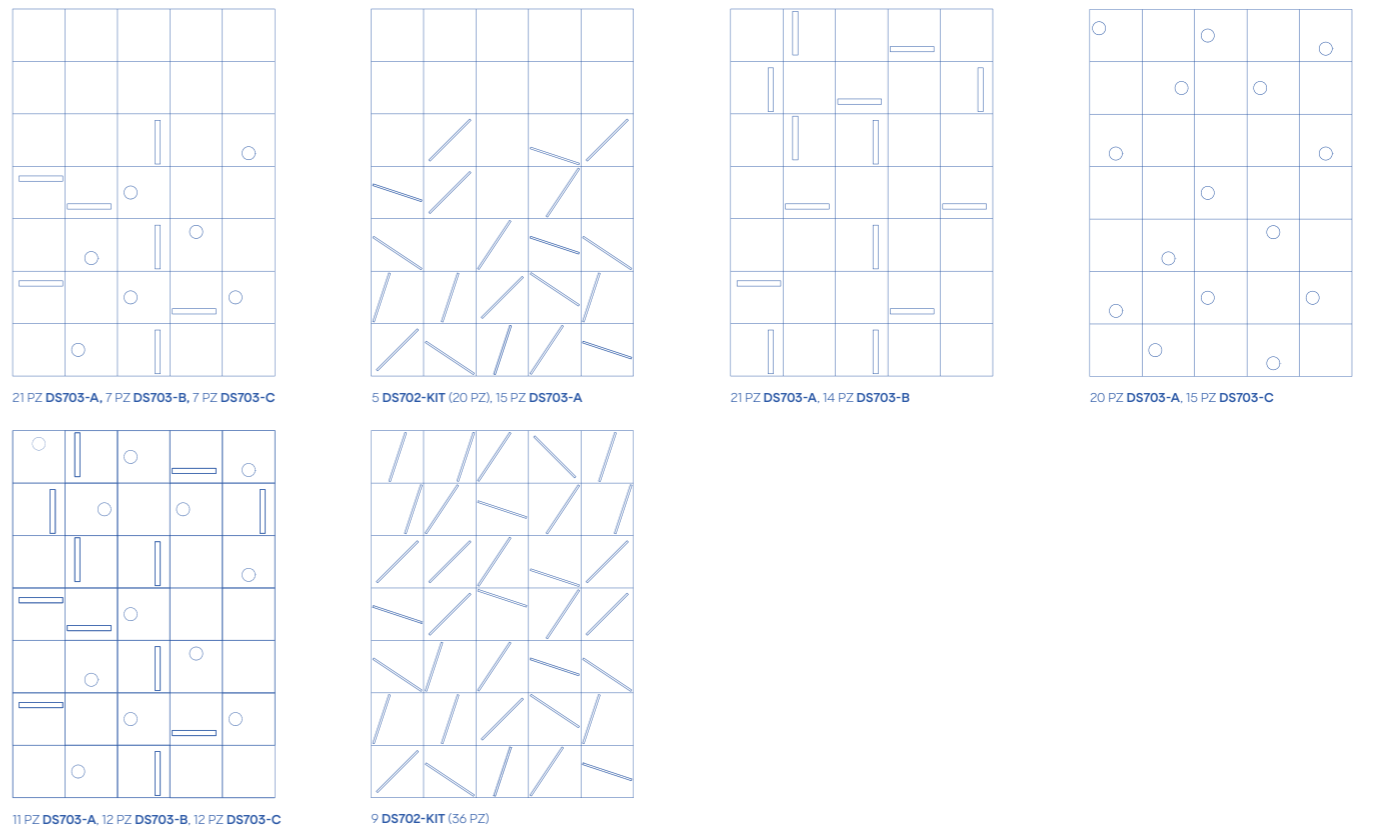

Laying



COPYCAT PP. 288 | 39, 49, 320

Metal finishes	DeLabré C3 DeLabré C1, DeErosion C23/C24/C25 DeLabré C2, DeErosion C26/C27/C28 DeLabré C16	 Dimensions 32,5 x 32 cm  Thickness Max 2 mm  Weight 12-13,3 kg/m ²
Installation	- Butt-jointed mosaics tile pre-assembled on a fiberglass mesh - It can be installed using epoxy adhesives and grouts - It can be processed on site with suitable tools, refer to Installation Manual for procedures and details	
Cladding	Wall and floor	
Usage	- Indoor only - Shower cabin and areas in direct contact with water excluded - Bathroom and kitchen are not recommend	
Details	- Hexagonal pieces featuring varying thickness - Minimum order 12 tiles - 12 tiles are required to clad 1 m ²	

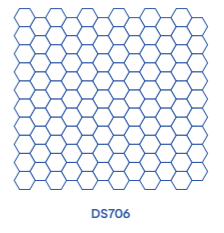

DIAMOND 30

P. 294

Metal finishes	Stainless steel DeLabré C12 Brass DeLabré C9 Copper DeLabré C7
Installation	- Butt-jointed mosaic pre-assembled on a fiberglass mesh - It can be installed using epoxy adhesives - It can be processed on site with suitable tools, refer to Installation Manual for procedures and details
Cladding	Wall and floor
Usage	- Indoor only - Shower cabin and areas in direct contact with water excluded - Bathroom and kitchen backsplash are not recommended
Details	- 30x30 mm square pieces punched on sides featuring the same thickness - Minimum order 9 tiles - 9 tiles are required to clad 1 m ²

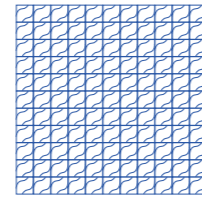

DS708

- Dimensions 33,5 x 33,5 cm
- Thickness 4 mm
- Weight 12-13,3 kg/m²

LOSANGA

P. 298 | 301

Metal finishes	DS712 Stainless steel DeLabré C19 Brass DeLabré C17 Copper DeLabré C18	DS713 Stainless steel DeLabré C22 Brass DeLabré C20 Copper DeLabré C21
Installation	- Butt-jointed mosaic pre-assembled on a fiberglass mesh - It can be installed using epoxy adhesives - It can be processed on site with suitable tools, refer to Installation Manual for procedures and details	
Cladding	Wall and floor	
Usage	- Indoor only - Shower cabin and areas in direct contact with water excluded - Bathroom and kitchen backsplash are not recommended	
Details	- Rhomboid pieces featuring different edge treatments - Minimum order 12 tiles - 12 tiles are required to clad 1 m ²	

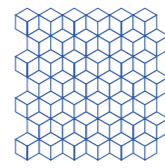

Losanga A
DS712
32,5 x 31,7 cm

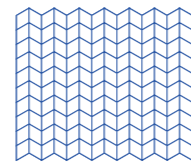

Losanga B
DS713
35 x 30 cm

- Dimensions 2 sizes available
- Thickness 2 mm
- Weight 12-13,3 kg/m²

SQUARE 30

PP. 302 | 20

Metal finishes	Stainless steel DeLabré C15 Brass DeLabré C13 Copper DeLabré C14
Installation	- Butt-jointed mosaic pre-assembled on a fiberglass mesh - It can be installed using epoxy adhesives - It can be processed on site with suitable tools, refer to Installation Manual for procedures and details
Cladding	Wall and floor
Usage	- Indoor only - Shower cabin and areas in direct contact with water excluded - Bathroom and kitchen backsplash are not recommended
Details	- 30x30 mm square pieces punched on sides featuring varying thickness - Minimum order 10 tiles - 10 tiles are required to clad 1 m ²

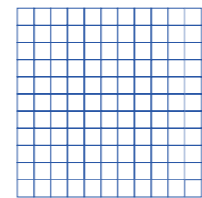

DS707

- Dimensions 33,5 x 33,5 cm
- Thickness 2 mm
- Weight 12-13,3 kg/m²

SQUARE 50

P. 306

Metal finishes	Stainless steel DeLabré C6 Brass DeLabré C4 Copper DeLabré C5
Installation	- Butt-jointed mosaic pre-assembled on a fiberglass mesh - It can be installed using epoxy adhesives - It can be processed on site with suitable tools, refer to Installation Manual for procedures and details
Cladding	Wall and floor
Usage	- Indoor only - Shower cabin and areas in direct contact with water excluded - Bathroom and kitchen backsplash are not recommended
Details	- 50x50 mm square pieces punched on sides featuring varying thickness - Minimum order 9 tiles - 9 tiles are required to clad 1 m ²

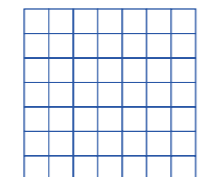

DS709

- Dimensions 35,2 x 35,2 cm
- Thickness 2 mm
- Weight 12-13,3 kg/m²

3D WALL

PP. 310 | 54

Metal finishes	Stainless steel DeLabré B E5, DeDeep G12 Brass DeLabré F2, DeSalt M7 Copper DeLabré E5, verdigris F7
Installation	- Magnetic fixing system on iron panel to be mechanically fixed on wall - Magnets included, fixing screws excluded
Cladding	Wall only
Usage	- Indoor only - Shower cabin and areas in direct contact with water excluded - Bathroom and kitchen backsplash are not recommended
Details	- Trapezoidal-section module - Panel to be defined on project basis included - Minimum order 25 modules - 25 modules are required to clad 1 m ² - Wall specifications are mandatory in order to check the feasibility of the cladding system

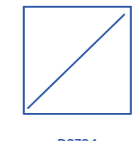

DS704

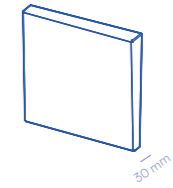

- Dimensions 20 x 20 cm
- Thickness 30 mm
- Weight 20 kg/m²

Laying

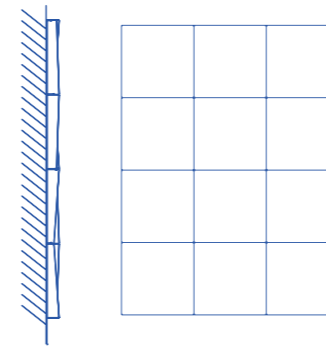

Assembly

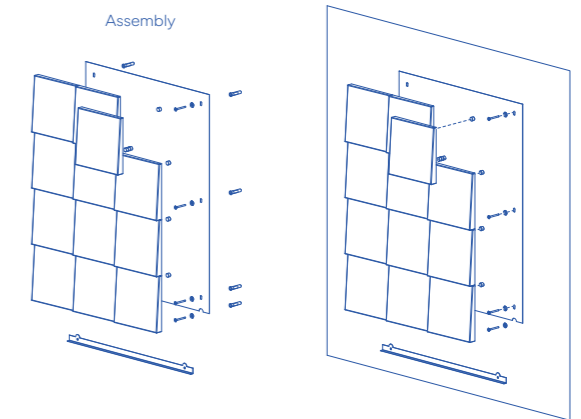

CIRCLE WALL

PP. 314 | 106, 130

Metal finishes	Stainless steel MIX Brass MIX Copper MIX
Installation	- Wall-mounting brackets system - Brackets included, fixing screws excluded - A template for the correct assembly is provided
Cladding	Wall only
Usage	- Indoor and outdoor - Shower cabin and areas in direct contact with water excluded - Bathroom and kitchen backsplash are not recommended
Details	- Rounded module pre-assembled on brackets following project ordered - Minimum order 44 modules - 44 modules are required to clad 1 m ² - Four bracket options - RAL 9010 or 9005 lacquered brackets to be specified at order confirmation - Wall specifications are mandatory in order to check the feasibility of the cladding system

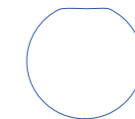

DS701

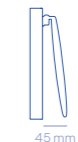

- Dimensions Ø18 cm
- Thickness min. 45 mm
- Weight 12 kg/m²

Laying

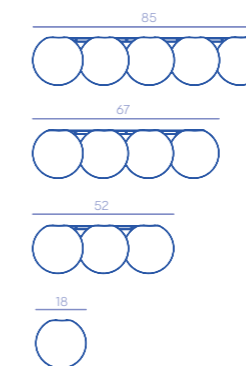
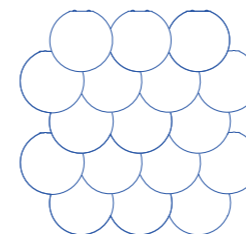
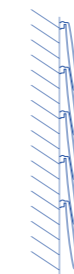

Assembly

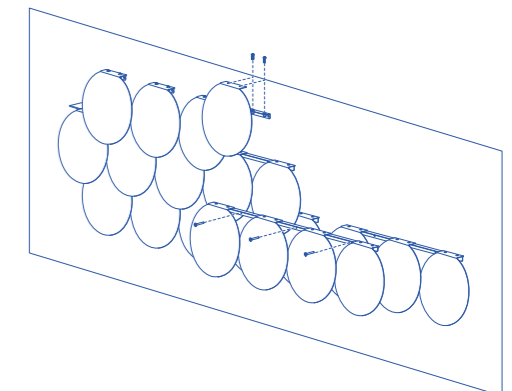

DECODE

P. 318 | 320

Metal finishes	Copper Brushed M10, DeLabré G5, orbitale DeLabré G4, DeOpale M2, rubin G11, verdigris F7
Installation	- Wall-mounting brackets system - Brackets included, fixing screws excluded
Cladding	Wall only
Usage	- Indoor only - Shower cabin and areas in direct contact with water excluded - Bathroom and kitchen backsplash are not recommended
Details	- Four hexagonal modules, smooth or punched as per drawings, with sound-absorbing properties compliant with Class D of the EN ISO 11654 standards on Sound Absorption - Absorption coefficient equal to Alfa=0.30 LM with acoustic absorption curve that varies between Alfa 0.30 LM and Alfa 0.60 LM - Certificate available upon request - 4 modules are required to clad 1 m ² - Wall specifications are mandatory in order to check the feasibility of the cladding system

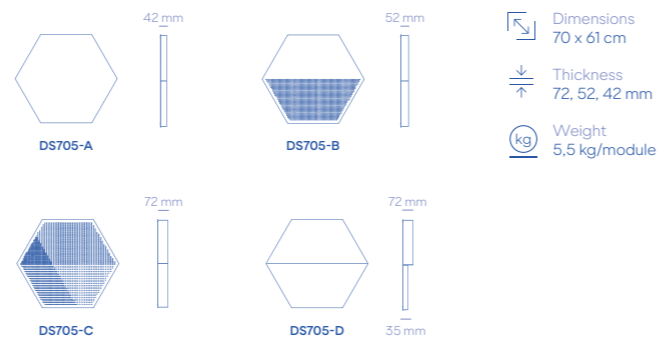

Laying

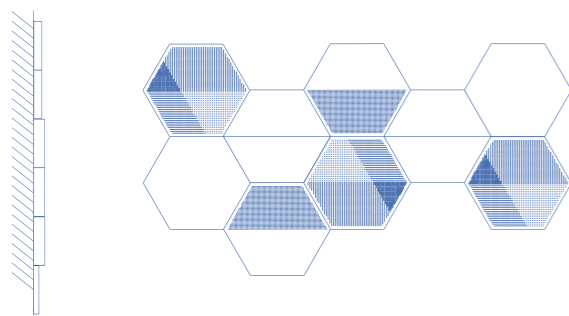

Assembly

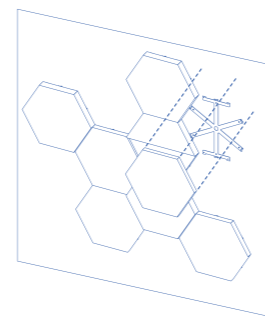

VERTICAL GREEN

P. 322 | 324

Metal finishes	MIX
Installation	- Wall-mounting brackets system - Brackets included, fixing screws excluded - A template for the correct assembly is provided
Cladding	Wall only
Usage	- Indoor and outdoor - Shower cabin and areas in direct contact with water excluded - Bathroom and kitchen backsplash are not recommended
Details	- Leaf shape module pre-assembled on brackets following project ordered - Minimum order 40 modules - 40 modules are required to clad 1 m ² - Four bracket options - RAL 9010 or 9005 lacquered brackets to be specified at order confirmation - Wall specifications are mandatory in order to check the feasibility of the cladding system

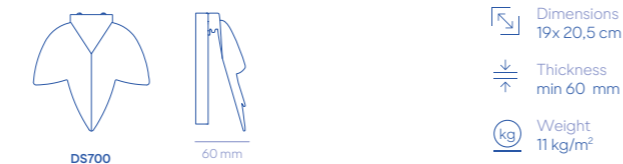

Laying

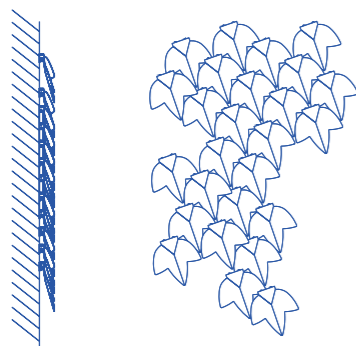

Assembly

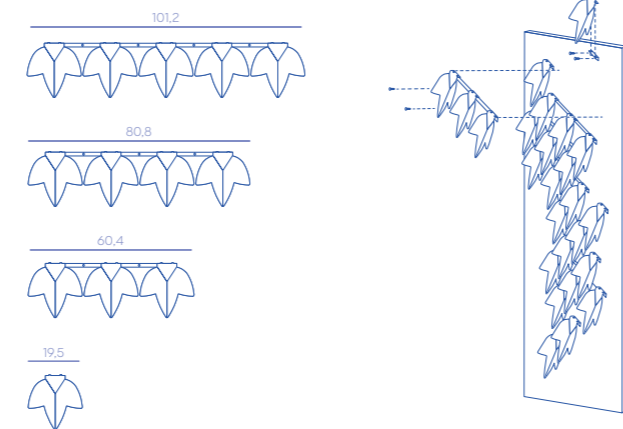

BOISERIE

PP. 326 | 16, 26, 63, 75, 83, 111, 116, 191, 346

Metal finishes	All finishes, subject to confirmation by De Castelli
Dimension	Project development required Stainless steel Maximum 1430x2900 mm Brass Maximum 1180x2900 mm Copper Maximum 930x2900 mm
Thickness	Minimum 22 mm (aluminum), minimum 35 (wood)
Weight	Minimum 25 kg/m ²
Installation	- Mechanical hanging wall fixing system is required, subject to project and wall state of affairs - Installation sequence from bottom to top
Cladding	- Wall - Ceiling, subject to confirmation by De Castelli
Usage	- Indoor - Outdoor, subject to confirmation by De Castelli - Shower cabin and areas in direct contact with water excluded - Bathroom and kitchen backsplash are not recommend
Details	- Boxed panels made on measure in different shapes - Coupled with inner support: wood or aluminum honeycomb, subject to application area - 30 mm hanging tolerance on top is required - Different hanging system possibilities - Possibility to add technical and/or esthetical features such as lighting, inspectable openings electrical systems, etc

Hanging fixing system

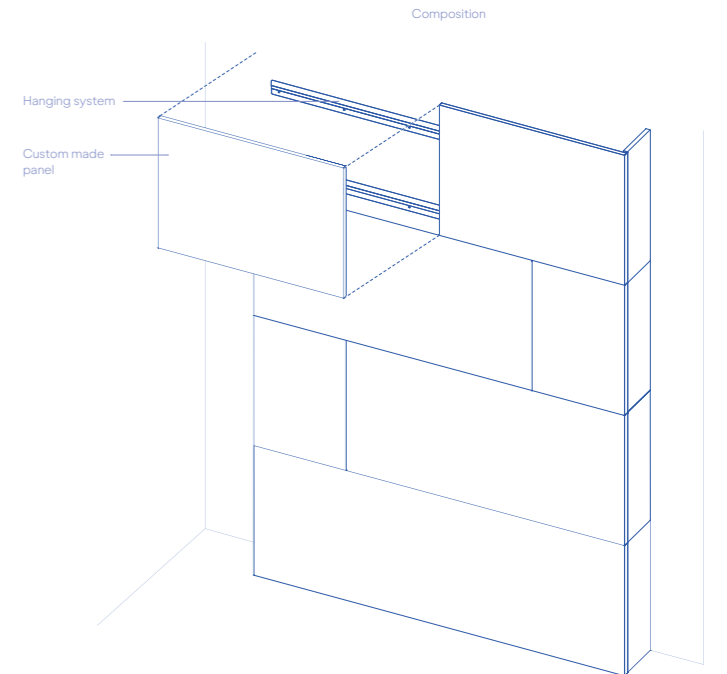
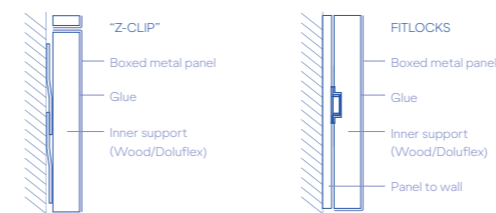

SCOMPOSTA

PP. 326 | 150, 170

Metal finishes	All finishes, subject to confirmation by De Castelli
Dimension	Project development required Stainless steel Ideal 600x1150 mm, bigger sizes subject to confirmation by De Castelli Brass Ideal 600x1150 mm, bigger sizes subject to confirmation by De Castelli Copper Ideal 600x1150 mm, bigger sizes subject to confirmation by De Castelli
Thickness	Minimum 35 mm
Weight	Minimum 18 kg/m ²
Installation	- Mechanical hanging wall fixing system is required, subject to project and wall state of affairs - Installation sequence from bottom to top
Cladding	Wall
Usage	- Indoor and outdoor, subject to confirmation by De Castelli - Shower cabin and areas in direct contact with water excluded - Bathroom and kitchen backsplash are not recommend
Details	- Empty boxed panels made on measure, square or rectangular shapes only - 30 mm hanging tolerance on top is required - Possibility to add technical and/or esthetical features such as lighting, inspectable openings electrical systems, etc

Hanging fixing system

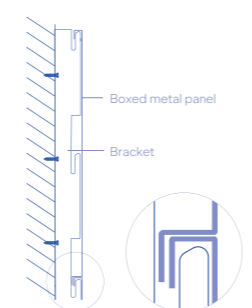

Assembly

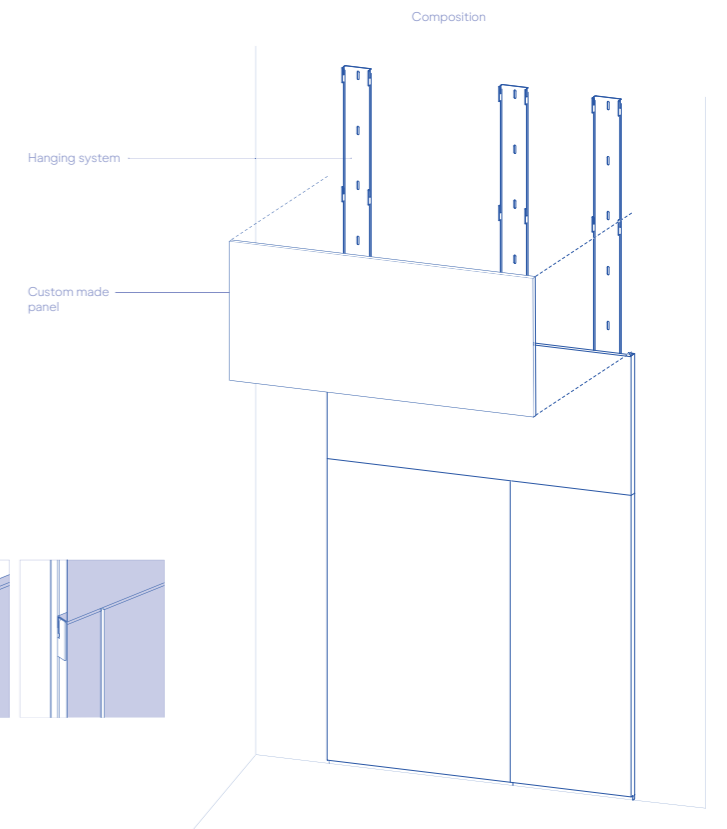
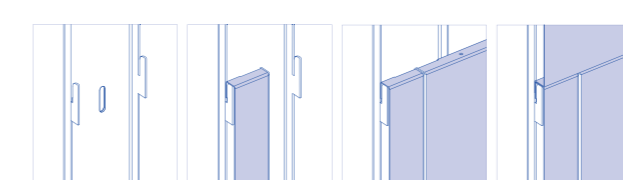

CANNETÉ

PP. 336 | 10, 47, 338

Metal finishes	
Aluminum	Brushed M11, DeLabré B E5, DeDarié E7
Brass	Brushed M9
Copper	Brushed M10
Dimension	
Project development required	
Panels	600x2670 mm (central); 645x2670 mm (closing, right and left types)
Thickness	
	Minimum 60 mm
Weight	
Aluminum	Minimum 12,2 kg/m ²
Brass/copper	Minimum 30,4 kg/m ²
Installation	
	Mechanical hanging wall fixing system is required, subject to project and wall state of affairs
Cladding	
	Wall
Usage	
	- Indoor and outdoor, subject to confirmation by De Castelli - Shower cabin and areas in direct contact with water excluded - Bathroom and kitchen backsplash are not recommend
Details	
	- Modular panels characterized by tubes in different diameters with aluminum hanging framed substructure - Completed with closing panels to hide thickness and structure - Hanging tolerance on top is required

Panels scheme

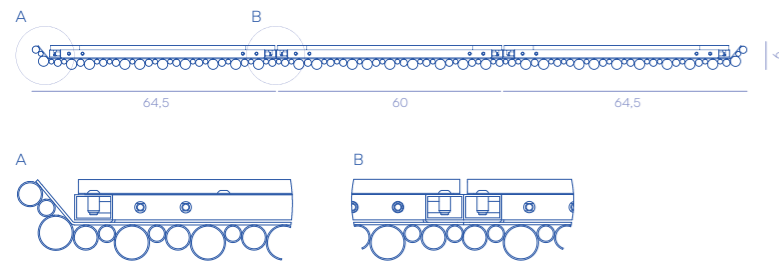

PLISSÉ

P. 340 | 343

Metal finishes	
Stainless steel	Satin D1, striped DeLabré B E6, DeDarié E7
Brass	Satin F1, striped DeLabré G6
Copper	Satin F5, striped DeLabré G7
Dimension	
Project development required	
Panels	645x2670 mm (closing and central)
Thickness	
	Minimum 60 mm
Weight	
Stainless steel	Minimum 7,4 kg/m ²
Brass and copper	Minimum 15 kg/m ²
Installation	
	Mechanical hanging wall fixing system is required
Cladding	
	Wall
Usage	
	- Indoor and outdoor, subject to confirmation by De Castelli - Shower cabin and areas in direct contact with water excluded - Bathroom and kitchen backsplash are not recommend
Details	
	- Modular panels characterized by regular folding with aluminum hanging framed substructure - Completed with closing panels to hide thickness and structure - Hanging tolerance on top is required

Panels scheme

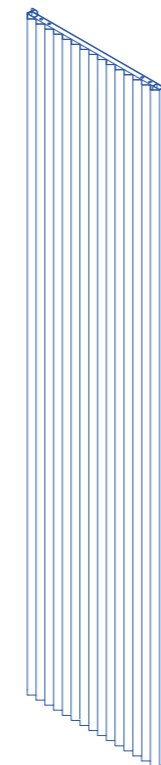
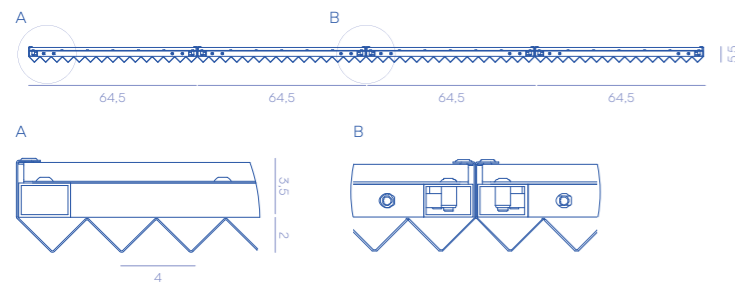

VELA

P. 344 | 121, 346

Metal finishes	
	All finishes, subject to confirmation by De Castelli
Dimension	
Project development required	
Panels	600-650 x 2670 mm (3 central types, 2 closing types)
Thickness	
	Minimum 60 mm
Weight	
Stainless steel	Minimum 17,4 kg/m ²
Brass	Minimum 18 kg/m ²
Copper	Minimum 18,5 kg/m ²
Installation	
	Mechanical hanging wall fixing system is required
Cladding	
	Wall
Usage	
	- Indoor and outdoor, subject to confirmation by De Castelli - Shower cabin and areas in direct contact with water excluded - Bathroom and kitchen backsplash are not recommend
Details	
	- Modular panels characterized by waves design with aluminum hanging framed substructure - The waves are highly artisan made, differences in shapes and dimensions can occur - Completed with closing panels to hide thickness and structure - Hanging tolerance on top is required

Panels scheme

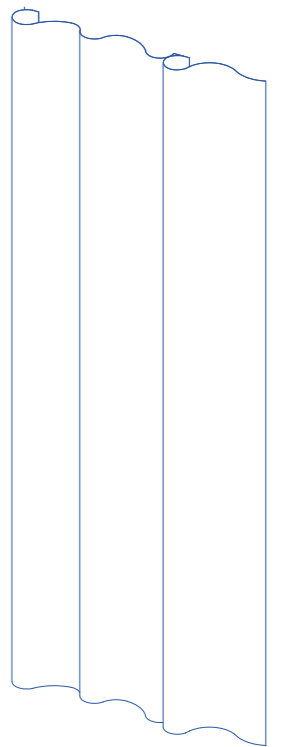
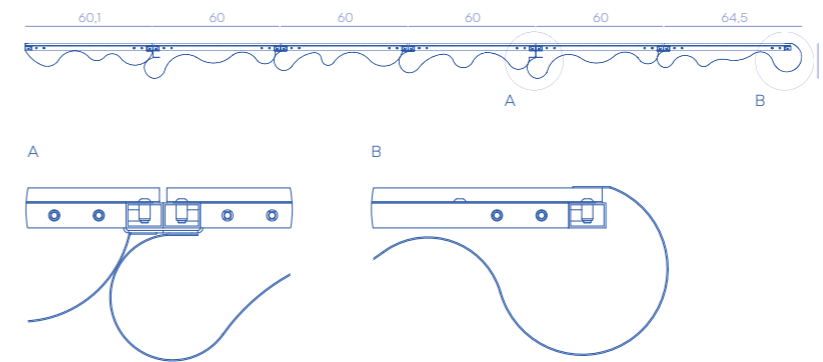

Cleaning and maintenance

METALS

Use only a soft cotton cloth dampened with water or use neutral (PH between 6.8 and 7.2) products suitable. Immediately dry the surface, in case of contact with water.

Do not use abrasive cloths, solvents, alcohol or aggressive detergents, which could irreparably damage the surface.

Corten

Corten is a type of steel characterized by a high mechanical strength and resistance to corrosion.

For an outdoor use, De Castelli supplies the material in an advanced state of oxidation. The oxidation stabilization takes place over 10-16 months, during which the corten rusts and particles, that can stain lighter and more permeable surfaces, may be released.

For an indoor use, corten is treated with a stabilizing wax to make the surface more pleasant to the touch and to avoid the release of impurities, typical of this material.

A wax kit for maintenance is available upon request. For cleaning corten we suggest just regular dusting of the surface without the use of detergents.

WOOD

Simply wipe with a soft cloth or use non-greasy products designed specifically for cleaning wood. We recommend that you avoid using solvents and alcohol. It should also be remembered that wood, being a natural material, can show differences in grain and/or colour from one batch to another.

MARBLE/STONES

For correct maintenance and a long life we recommend removing stains and liquids immediately, regardless of their nature, by simply using a soft, damp cloth. Do not use abrasive brushes or sponges or acid detergents as they could irreparably damage the surface of the product, making it dull and with halos.

FABRICS

To eliminate stains, please remember that a range of precautions and specific products exist depending upon the nature of the stain to be removed. It is therefore advisable to contact a fabric specialist who can advise on the most suitable solution to be used. For washing, refer to the fabric technical data sheet. However, hand or machine washing in water (up to 30 degrees) is recommended only if the fabric has been pre-washed. Please note that the exposure of any fabric consisting of natural fibres to sunlight may cause discolouration. Fabrics may vary in colour from one batch to another and therefore no liability is accepted for differences in colour present in items purchased at different times.

Pulizia e manutenzione

METALLI

Utilizzare solo un panno di cotone morbido ed inumidito con acqua o appositi prodotti neutri (PH compreso tra 6,8 e 7,2). Asciugare bene la superficie in caso di ristagno d'acqua.

Non usare panni abrasivi, solventi, alcool o detergenti aggressivi che potrebbero rovinare la superficie in modo irreparabile.

Corten

Il corten è un tipo di acciaio caratterizzato da una elevata resistenza meccanica e resistenza alla corrosione.

Per uso esterno, De Castelli fornisce il materiale in uno stato avanzato di ossidazione. La stabilizzazione dell'ossidazione avviene nell'arco di 10-16 mesi e durante questo periodo potrebbe verificarsi il rilascio di particelle di ruggine che possono macchiare le superfici più chiare e permeabili.

Per uso interno, il corten viene trattato con una cera stabilizzante per poter rendere la superficie più gradevole al tatto e per evitare il rilascio di impurità, tipico di questo materiale.

Su richiesta è disponibile un kit cera per la manutenzione periodica della superficie. Per la pulizia del corten suggeriamo di procedere con un semplice spolvero della superficie senza utilizzare nessun tipo di detergente.

LEGNO

È sufficiente passare un panno morbido o utilizzare prodotti non grassi, specifici per la pulizia del legno. Si raccomanda di evitare solventi ed alcool. Si ricorda inoltre che il legno, in quanto materiale naturale, può mostrare differenze di venature e/o colore da una partita all'altra.

MARMO/PIETRE

Per una corretta manutenzione ed una lunga durata consigliamo di procedere alla rimozione immediata di macchie e liquidi, di qualunque natura essi siano, utilizzando semplicemente uno straccio umido ed un panno morbido. Non utilizzare spazzole o spugne abrasive o detergenti acidi in quanto potrebbero intaccare in modo indelebile la superficie del prodotto, rendendola opaca e con alonature diffuse.

TESSUTI

Per eliminare le macchie ricordarsi che, a seconda della causa delle stesse, esistono cautele e prodotti specifici. È pertanto consigliato rivolgersi ad un tintore specializzato che potrà indicare le soluzioni più idonee. Per il lavaggio, far riferimento alla scheda tecnica dei tessuti. Ad ogni modo il lavaggio ad acqua, a mano o a macchina (massimo a 30 gradi), è consigliato solo nel caso in cui il tessuto sia stato prelavato. Si ricorda che l'esposizione di qualsiasi tessuto costituito da fibre naturali alla luce del sole ne provoca lo scolorimento. I tessuti possono variare di tonalità da una partita all'altra e pertanto si declina ogni responsabilità per differenze di colore presenti in elementi acquistati in tempi diversi.

Installation

For "Tiles" and "Mosaics" products categories, please refer to the Installation Manual which can be downloaded from De Castelli website www.decastelli.com/download.

The Installation Manual contains all the information relating to the preliminary conditions, recommended products and correct installation procedures.

For "Decorative" and "Cladding solutions" products categories, the installation procedures are specific to each project and are delivered together with the order as Assembly Instructions.

Installazione

Per i prodotti di rivestimento delle categorie "Tiles" e "Mosaics" si prega di fare riferimento al Manuale di Installazione scaricabile dall'area download del sito De Castelli www.decastelli.com/download.

Il Manuale di Installazione contiene tutte le informazioni relative alle condizioni preliminari, ai prodotti consigliati e alle corrette procedure di posa.

Per i prodotti di rivestimento delle categorie "Decorative" e "Cladding solutions" le procedure di installazione sono specifiche di ogni progetto e sono consegnate contestualmente all'ordine come Istruzioni di Montaggio.

Legal notes: all contents are confidential and any right is reserved exclusively to De Castelli S.r.l. following current regulations. In the absence of a written declaration by De Castelli S.r.l., any copy, distribution or disclosure of this catalogue is strictly forbidden.

Note legali: ogni diritto sui contenuti presenti in questo catalogo è riservato a De Castelli S.r.l. ai sensi della normativa vigente. È espressamente vietata qualsiasi riproduzione, divulgazione e/o distribuzione, totale o parziale, del contenuto di questo catalogo, in assenza della previa autorizzazione scritta di De Castelli S.r.l.

De Castelli Srl – Headquarters
Via delle Industrie, 10
31035 Crocetta del Montello TV, Italy
+39 0423 638218

De Castelli Gallery – Milan
Via Uberto Visconti di Modrone, 20
20122 Milan MI, Italy
+39 02 76006999

info@decastelli.com
decastelli.com

Metal Affinities Catalogue 2024
Edited by De Castelli

Graphics & Art Direction
Studio Nuvole

Printed by
Grafiche Antiga

Photos
Matteo Imbriani, Styling: Veronica Leali, Styling collaboration: Micol Cerani
PP. 16, 17, 38, 48, 62, 83, 87, 96, 116, 134, 150, 158, 187, 191, 195, 209, 223,
234, 236, 238

StudioSZ Photo
PP. 26, 328

Donato Di Bello
P. 330

Uzi Porat
P. 329

Matt Livey
P. 332

Still life images
Alberto Parise

Renders
Bruger Studio
PP. 10, 27, 30, 47, 54, 58, 74, 78, 106, 110, 120, 124, 138, 170, 218, 338, 342

Hangar Design Group
PP. 20, 130, 163, 270, 271, 274, 278, 279, 280, 282, 283, 286, 287, 290, 291,
292, 296, 297, 300, 301, 305, 308, 309, 312, 317, 325, 333, 334

Thanks to
Astep, Bonaldo, Carl Hansen & Son, Cassina, Davide Groppi,
DCW éditions, De Padova, Driade, Federica Bubani, Flos,
Forma & Cemento, Francesca Verardo, Gumdesign, Illulian,
Light and Ladder, Living Divani, Luceplan, Lucie Kaas, Mamate, Mani
Ceramics di Britta Hermann, Mason Editions, Minotti, Porro, Salvatori,
Urus Mihic, Via Bizzuno, Vibia, Zilio Aldo